

ADOBE® INDESIGN®

Help and tutorials

January 2014



Contents

What's new.....	1
What's new in InDesign CC version 9.2.....	2
What's new in InDesign CC version 9.0.....	10
What's new in CS6.....	18
Sync Settings using Adobe Creative Cloud CC.....	28
EPUB enhancements in InDesign CC.....	32
InDesign getting started tutorials.....	37
Create new documents.....	43
Create new documents (Chinese, Japanese, and Korean only).....	47
Workspace and workflow.....	52
Create new documents.....	53
Sync Settings using Adobe Creative Cloud CC.....	57
Working with files and templates.....	61
Customize menus and keyboard shortcuts.....	67
Workspace basics.....	71
Recovery and undo.....	82
Working with managed files.....	84
Viewing the workspace.....	90
Understanding a basic managed-fileworkflow.....	95
Toolbox.....	102
Sharing content.....	108
Saving documents.....	114
PageMaker menu commands.....	119
Default keyboard shortcuts.....	127
Converting QuarkXPress and PageMaker documents.....	143
Assignment packages.....	148
Adjusting your workflow.....	151
Layout and design.....	154
Create new documents.....	156
Generate QR codes CC.....	160
Creating text and text frames.....	163
Aligning and distributing objects.....	170
Footnotes.....	174
Creating book files.....	178
Creating an index.....	185
Creating a table of contents.....	198
Liquid Layouts and Alternate Layouts CC, CS6.....	204
Linked content CC, CS6.....	209
Creating type on a path.....	213
Creating documents.....	218
Create new documents (Chinese, Japanese, and Korean only).....	221
Clipping paths.....	226
Add basic page numbering.....	230
About pages and spreads.....	233
Text.....	236
Threading text.....	237

Wrapping text around objects.....	243
Arabic and Hebrew features CC, CS6.....	249
Text Frame fitting options CC, CS6.....	259
Spell-checking and language dictionaries.....	261
Editing text.....	269
Captions.....	281
Adding text to frames.....	284
Creating text and text frames.....	293
Footnotes.....	300
Find/Change.....	304
Bullets and numbering.....	321
Tracking and reviewing changes.....	331
Text variables.....	335
Linked content CC, CS6.....	340
Glyphs and special characters.....	344
Formatting CJK characters.....	352
Creating type on a path.....	359
Articles (CS5.5).....	364
Anchored objects.....	366
Adding editorial notes in InDesign.....	375
Linked stories CS5.5.....	377
Styles.....	379
Drop caps and nested styles.....	380
Paragraph and character styles.....	387
Object styles.....	397
Working with styles.....	403
Typography.....	405
Using fonts.....	406
Aligning text.....	412
Formatting paragraphs.....	417
Formatting characters.....	422
Text composition.....	430
Formatting text.....	436
Bullets and numbering.....	440
Leading.....	450
Tabs and indents.....	452
Kerning and tracking.....	460
Formatting CJK characters.....	464
Arabic and Hebrew features CC, CS6.....	471
Tables.....	481
Table and cell styles.....	482
Formatting tables.....	488
Creating tables.....	494
Selecting and editing tables.....	498
Table strokes and fills.....	504
Interactivity.....	509
Hyperlinks.....	510
Cross-references.....	518
Interactive web documents for Flash.....	526

Animation.....	532
Structuring PDFs.....	537
Page transitions.....	542
Movies and sounds.....	544
Forms CC, CS6.....	548
Dynamic PDF documents.....	551
Buttons.....	555
Bookmarks.....	565
Drawing and painting.....	567
Drawing with the Pen tool.....	568
Drawing with the Pencil tool.....	573
Understanding paths and shapes.....	576
Editing paths.....	579
Drawing with the line or shapetools.....	587
Compound paths and shapes.....	590
Change corner appearance.....	596
Applying line (stroke) settings.....	598
Color.....	603
Applying color.....	604
Working with swatches.....	610
Using colors from imported graphics.....	618
Understanding spot and process colors.....	620
Tints.....	622
Mixing inks.....	624
Gradients.....	627
Understanding color management.....	633
Transparency.....	635
Adding transparency effects.....	636
Flattening transparent artwork.....	646
Blending colors.....	655
Exporting and publishing.....	658
Export content for EPUB CC.....	659
Export content to HTML CC.....	663
Exporting to Adobe PDF.....	666
Export to JPEG format.....	672
Export content for EPUB CS6.....	674
Exporting.....	679
Exporting XML.....	686
Export content to HTML CS6 & CS5.5.....	689
Export content for EPUB CS5.5.....	692
Adobe PDF options.....	696
Printing.....	705
Preparing PDFs for service providers.....	706
Preflighting files before handoff.....	708
Preparing to print separations.....	716
Printing documents.....	721
Printing booklets.....	732
Printer's marks and bleeds.....	737
Trap presets.....	740

Trapping documents and books.....	746
Printing thumbnails and oversizeddocuments.....	750
Printing graphics and fonts.....	753
Overprinting.....	755
Managing color.....	759
Inks, separations, and screen frequency.....	763
Creating PostScript and EPS files.....	769
Adjusting ink options for trapping.....	775
Digital publications.....	777
Export content for EPUB CC.....	778
Liquid Layouts and Alternate Layouts CC, CS6.....	782
Export content for EPUB CS5.5.....	787
Export content for EPUB CS6.....	791
Digital Publishing Suite overview.....	796
Articles (CS5.5).....	797
Automation.....	799
Scripting.....	800
Plug-ins.....	803
Data merge.....	804
Accessibility.....	814
Structuring PDFs.....	815
Forms CC, CS6.....	820
Articles (CS5.5).....	823

What's New

What's new in InDesign CC version 9.2

January 2014

Typekit Desktop Fonts integration

Hyperlinks enhancements

EPUB enhancements

Other enhancements

For information on new features in other InDesign versions, see:

- [What's New in InDesign CC version 9.0 \(June 2013\)](#)
- [What's New in InDesign CS6 \(May, 2012\)](#)

[To the top](#)

Typekit Desktop Fonts integration

+ New in InDesign

As a paid Creative Cloud subscriber, you get access to Typekit library of fonts for the Web and the desktop. Generally, you use the Creative Cloud Desktop app to sync Typekit fonts on your computer, but now you can actually browse and sync Typekit fonts from within InDesign.

Typekit desktop fonts are now fully integrated with InDesign. With this seamless integration, you can now easily do the following from within InDesign:

- Find missing Typekit fonts in your documents and sync those fonts from Typekit.
- Browse and add new fonts from the Typekit Website by clicking the Add Fonts from Typekit button in the Type menu.
- Find your synced Typekit fonts quicker in the Font menu with the new Typekit font filter.

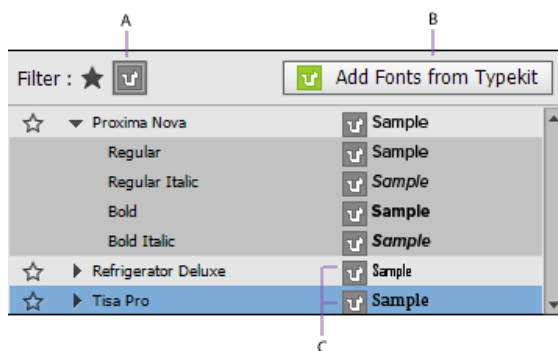

A. Typekit font filter B. Browse and add fonts from Typekit website C. Typekit font indicator icon

Caution: Typekit fonts cannot be packaged with other fonts while creating an InDesign package file. However, they can be printed and used in digital documents, such as PDFs or EPUBs.

More on working with Typekit fonts (article) | [Typekit desktop fonts and Font Menu Enhancements](#) (video)

[To the top](#)

Hyperlinks enhancements

 Enhanced in InDesign CC

The major pain points around creating, editing, and managing hyperlinks have been addressed in this release of InDesign.

Creating hyperlinks simplified

Creating a hyperlink in InDesign is now incredibly simple. You can create a hyperlink with just a right-click gesture. Hyperlinks now have a separate *Hyperlink* character style – blue and underlined. Also, InDesign now creates an affordance on non-text objects similar to the button affordance – dotted line around the object frame.

To create a hyperlink:

1. Right-click the selected text or object, and then choose Hyperlinks > New Hyperlink. The New Hyperlink dialog box is displayed.

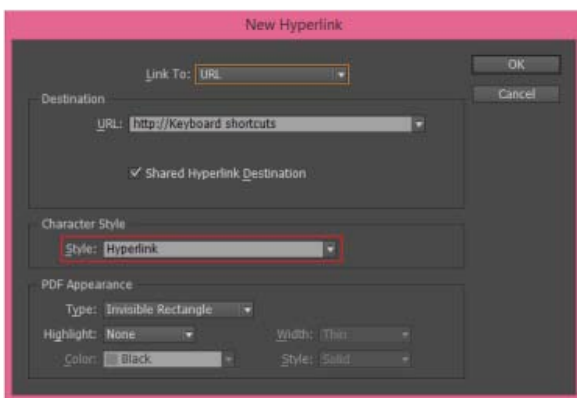

2. Specify an appropriate URL destination.
3. By default, InDesign applies the Hyperlink style to the selected text or object. For text, you can easily select a different style from the Style drop-down. For a non-text object, InDesign applies a design time visual identifier to the links – dotted line around the object with the color inherited from layer color.

Character style applied to text links



The character style is added to the document character style list. The style will print and export.

Visual identifier applied to object links



A dotted outline is applied to the linked objects. It's a visual identifier only and will not print or export.

Editing hyperlinks made easy

The Edit Hyperlink dialog used to default to the Shared Destination, and it was quite confusing. Now the Edit feature is available on right-click and the dialog automatically points to the type of hyperlink you are editing.

To edit an existing hyperlink, right-click the selected text or object and then choose *Hyperlinks > Edit Hyperlink*. The Edit Hyperlink dialog box is displayed with an appropriate type of link already selected.

Manage hyperlinks easily

We have revamped the Hyperlinks panel to make it more convenient for you to manage your hyperlinks using the panel.

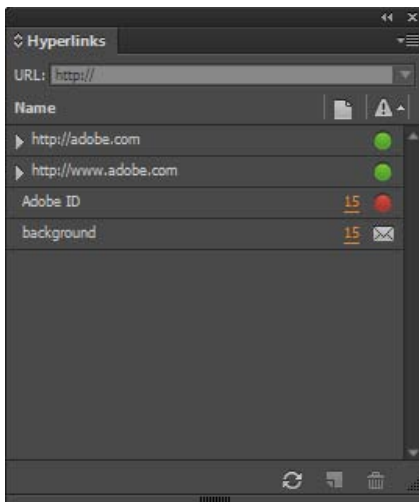

- Added traffic lights to quickly check and provide instant feedback on URL availability: Green indicates a valid URL and red indicates an invalid URL. Clicking the light icon takes you to the destination.
- Added page numbers similar to the Links panel: Clicking a page number takes you to the page where the link is and selects the link.
- Clicking on other icons, such as email or anchor, takes you to the destination.
- Added refresh control to refresh URL availability manually.
- Links pointing to the same destination are grouped together.

Also, Hyperlink and Cross-References panel are now separated.

Additional enhancements

- The *Delete All* button is replaced with *Delete Unused*.

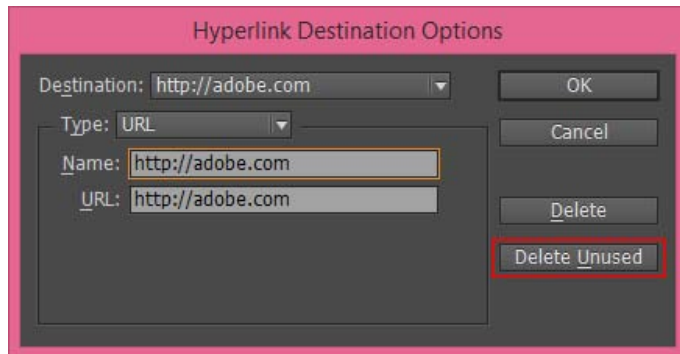

- The *Delete Unused Destination* deletes the destinations that were added earlier but are not in use currently.

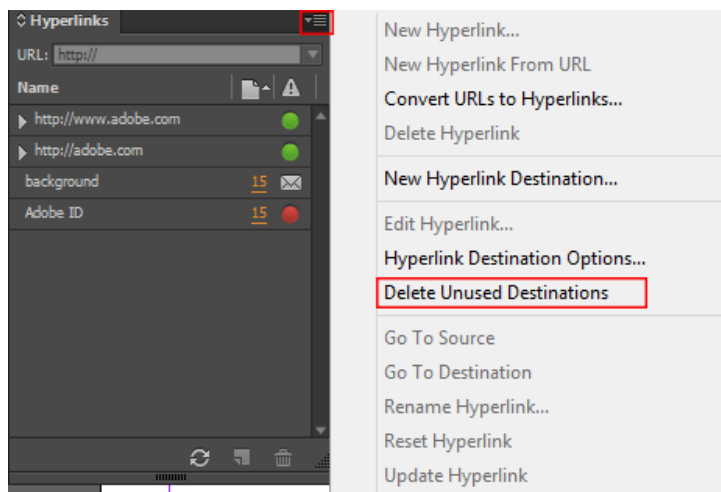

More on [Simplified Hyperlinks](#) (video)

[To the top](#)

EPUB enhancements

 *Enhanced in InDesign CC*

Many significant improvements and enhancements have been made to the EPUB capability of InDesign. (To see the list of all changes, refer to [InDesign_EPUB_Changes_CC_9.0_to_9.2.pdf](#).)

Create reflowable interactive books

Create footnotes that popup over the page you're reading

You now have a new control for iBooks Reader pop-up footnotes – **Inside a Pop-up** footnote placement option for EPUB3. The Footnote Placement option on the EPUB export options dialog has been changed to display a drop-down listing the placement options.

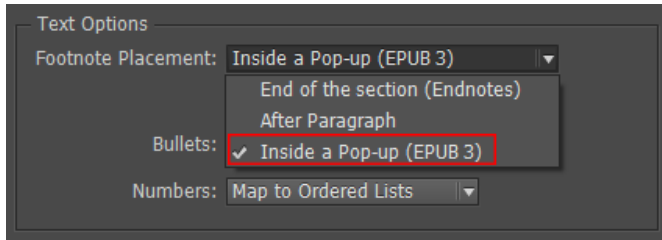

This new option changes the markup of the footnote reference and the footnote content wrapper to enable pop-up footnotes in iBooks Reader. The footnote text becomes visible only when a reader touches the footnote reference.

More control over EPUB export

More accurate representation of exported text color, tables, and nested styles

InDesign now successfully maps Color attributes including tint in Paragraph styles to CSS properties. Now the Gradient Colors are also supported when applied using a paragraph style.

InDesign now successfully emits the markup for an applied Cell Style including the class associated with the style. Also, regional cell styles, in addition to an applied Cell Style and Cell Attributes overrides, are now emitted and exported properly.

We have improved support for Nested Styles and Dropcaps by resolving important issues around them:

- Nested Styles are now fully supported.
- Font embedding for Dropcaps works fine now. Also, the dropcap's float property now respects paragraph direction.

Improved CSS handling of native InDesign objects, images, and groups

Transforms applied on objects, such as rotation on an object containing a graphic, are now successfully mapped to CSS. InDesign now precisely maps the transforms to the generated CSS for graphic, audio and video object content, and groups.

Example: Transforms applied on a graphic and how it maps to CSS



```
div._idGenPageitem-2 {
  -webkit-transform:translate(0.000px,0.000px) rotate(330.000deg) skew(0.000deg) scale(1.000,1.000);
  -webkit-transform-origin:50% 50%;
  display:inline-block;
  height:173px;
  width:230px;
}
```

Improved handling of bullets and numbering

Custom bullets with GID and Font are now replaced with standard bullet character. Font embedding for custom bullets is also supported now. For EPUB3 exports, we now support additional CSS list-style-type values.

Support for additional list types and text align last within CSS properties

InDesign now supports additional CSS properties for CJK and ME - *list-style-type(s)*, *-epub-text-align-last*, and gradients on paragraphs.

Create EPUBs for any market

Japanese

InDesign now supports Pre-Character Ruby and Auto TCY. With the improved support for Ruby, and J Vertical composition including TCY and Auto TCY, you can now successfully create EPUBs for Japanese market.

Middle East

InDesign now supports Paragraph and Character direction through dir tag attribute. This improves the handling of right to left direction languages, and lets you successfully create EPUBs for Arabic market.

Changes to User Interface

The **Object Export Options** is now available in the context menu.

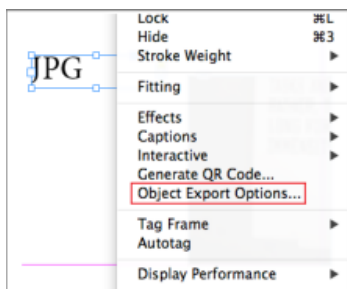

- The **Use Original Image** option is added to the *Object Export Options* dialog box and the *EPUB Export Options* dialog box. This new control requests that the export must use the placed image rather than the rasterized image.

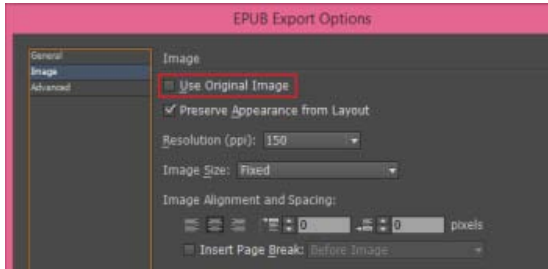
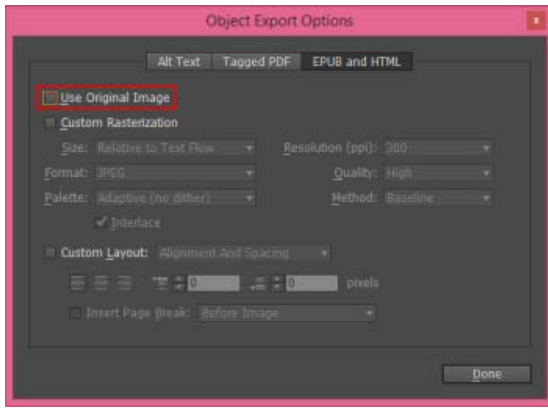

- The **Settings Apply to Anchored Objects** option is removed from the Image options of the *EPUB Export* dialog box.

More on [EPUB enhancements](#) (video)

[To the top](#)

Other enhancements

 *Enhanced in InDesign CC*

Seamless update

- The recent document list will not automatically clear out when you apply updates.
Note: This will take effect for updates done after InDesign CC 9.2.0.
- The **Color Theme** setting does not automatically get reset to Medium Dark when you apply updates.

Active preflight profile in the document status bar

InDesign now displays the name of the currently active preflight profile in the document status bar, allowing you to change it from right there.

'Protect When Applying Fonts' for Roman fonts

The *Protect When Applying Fonts* setting now applies to Roman fonts as well.

Cross-references performance improvement

In the previous versions of InDesign, if you had a document with multiple cross-references to other documents, you would notice a lag in typing text in your document. This especially happens when the cross-references are pointing to multiple docs and those docs are not open.

This issue has been fixed now. You won't notice any lag in typing text in your document even though all the referenced docs are not open.

Text selection or highlight behavior restored

The text selection or highlight behavior has been reverted to how it was in ID CS6. Now the system (OS) highlight color is not used to highlight text. This change has been made to Layout text selection/highlight only. In the Story Editor, behavior is still as it was in CC.



Twitter™ and Facebook posts are not covered under the terms of Creative Commons.

[Legal Notices](#) | [Online Privacy Policy](#)

What's new in InDesign CC version 9.0

June 2013

[Sync settings using Adobe Creative Cloud](#)

[User interface modernization](#)

[Platform enhancements](#)

[QR codes](#)

[Font menu enhancements](#)

[EPUB enhancements](#)

[Adobe Exchange panel](#)

[Other updates](#)

For information on new features in other InDesign versions, see:

- [What's New in InDesign CC version 9.2 \(January 2014\)](#)
- [What's New in InDesign CS6 \(May, 2012\)](#)

[To the top](#)

Sync settings using Adobe Creative Cloud

 *New in InDesign CC*

The new Sync Settings feature enables individual users to sync their settings using Creative Cloud. If you use two computers, for example, one at home and another at work, the Sync Settings feature makes it easy for you to keep those settings synchronized on these two computers. Also, if you have replaced your old computer with a new one and have reinstalled InDesign, you can get the application set up quickly with all your settings in place by just pressing a button.

For more information, see [Sync Settings using Adobe Creative Cloud](#).

[To the top](#)

User interface modernization

 *Enhanced in InDesign CC*

InDesign, by default, is now available with a dark theme, which is in line with recent changes in other products such as Photoshop, Illustrator, and Premiere Pro. This theme enables a more pleasant visual experience, especially while working with rich colors and designs. It also makes cross-application work simpler than ever.



New vibrant color themes for user interface: Dark, medium light, light, and medium dark

You can easily vary the brightness of the user interface to a tone you prefer from the Interface option in the Preferences dialog. You can enable Match Pasteboard to Theme Color to set the tone of the pasteboard area to match the brightness of the interface. If you prefer the classic (CS6 or prior) InDesign pasteboard color, you can deselect this option.

For more information, see [Tour the new interface \(video\)](#).

[To the top](#)

Platform enhancements

 *Enhanced in InDesign CC*

HiDPI support

To take advantage of advancements in high-resolution display technologies, InDesign now includes native support for high-resolution displays. This feature is currently available for the Mac OS (for example, the MacBook Pro with Retina display). You can now enjoy working with a sharper and clearer environment on these devices. You can view text and complex artwork in greater clarity, and in colors and hues that appear more vibrant than before.

64-bit support on Mac and Windows

InDesign, InCopy, and InDesign Server are all now 64-bit applications to leverage RAM beyond 3GB on both Mac and Windows. All the features of InDesign have been enabled to work in 64-bit mode. With support for 64-bit architecture, general processing is faster and more RAM can be made available to the application. This speeds up processes, and makes it easier to work with several large files at a time.

QR codes

 *New in InDesign CC*

You can now generate and edit high quality independent QR code graphics from within InDesign. The generated QR code is a high-fidelity graphic object that behaves exactly like native vector art in InDesign. You can easily scale the object and fill it with colors. You can also apply effects, transparency, and printing attributes such as overprinting, spot inks, and trappings to the object.

The Generate QR Code feature is accessible via Menu > Object, and via the right-click context menu when an empty frame is selected.

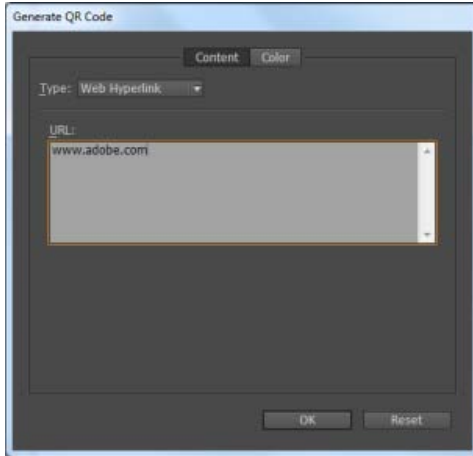

Once placed inside a document, the QR code is treated as a traditional EPS object, except that a tooltip appears on hovering over the object, revealing the content details.



For more information, see [Generate QR codes \(video\)](#) or [Generate QR codes \(article\)](#).

Font menu enhancements

 *Enhanced in InDesign CC*

Several enhancements have been made to the Font menu, including the way fonts are displayed, searched, and selected. You can now also identify Favorite fonts for easy access, and apply fonts on selected text while browsing so that you can see how your fonts will look in the layout.

Major enhancements

- Search fonts by any part of the name
- Show fonts with families in a sub-menu
- Apply font selection by arrow keys to the selected text
- Manage your favorite fonts

New Fonts menu widget

The new fonts widget has been added in the Character panel and the Control panel. The widget has four elements.

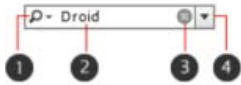

1. Button control to toggle between the two available search modes
2. Text field to display selected font name or enter the search keyword
3. Clear search icon; appears only when some text is entered in the search field
4. Drop-down arrow button to display the font list – all fonts or search results

Clicking the drop-down arrow button without entering any search string displays a pop-up list of all installed fonts.

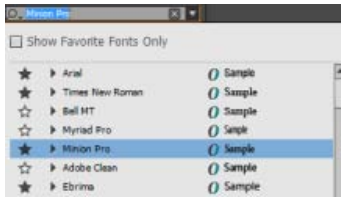

Search fonts made easy

You can now easily search for the fonts you are looking for. There are two modes for doing this:

- Search Entire Font Name: Looks for a match anywhere in the Font Name. As you type in some text, matched font names are displayed in a popup.
- Search First Word Only: The first match begins with the entered text is suggested and the remaining portion of the font name is populated automatically.

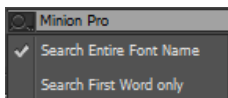

Using the new search

As you clear the font name and start typing, the search results start appearing in the popup. A Cross icon appears in the widget to help you clear off the results quickly and start afresh. The search results are displayed as a flat list (without grouping of font and associated family). For example, Ebrima is a family and has two styles – Regular and Bold. If you search for Ebrima, both Regular and Bold are displayed as separate entries and

are not grouped as Ebrima.

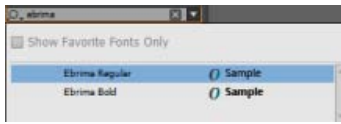

Browse and apply fonts

You can browse the fonts list with the Arrow keys. On selection, the font style is applied to the selected text in your layout or document for preview. Clicking a font name or pressing the Enter key commits the font style and closes the Font List popup.

Manage your favorite fonts

You can add or remove a font from the Favorite list by clicking the Favorite icon (star) in the font list. When you click the drop-down arrow key, you see the Favorite icon highlighted in Black for the fonts which are marked as favorite.



Adding or removing a font belonging to a family adds or removes the entire font family to the Favorite list.

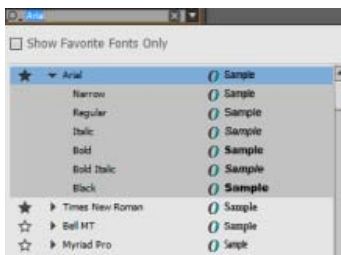

For more information, see [Font Menu Enhancements in Adobe InDesign CC \(video\)](#).

[To the top](#)

EPUB enhancements

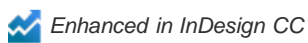

EPUB Export workflows have been simplified: several improvements in the existing features, additional control while authoring, and a few brand-new features.

Support for table of contents (TOC) stories

TOC Story has been redone so that any existing, possibly edited TOC story is now exported like any other story. If portions of these TOC stories are copied and pasted elsewhere, the hyperlinks back to the PDF page and the source paragraphs (in case of an EPUB Export) remain live. The NCX (navigation) file, required in the EPUB package, cannot use an existing TOC and is generated using the TOC style as in CS6.

- If you don't want page numbers in the TOC, you can remove them manually or generate the TOC without page numbers.
- TOC stories generated in CS6 and before must be regenerated in InDesign CC for the links to be live.

Support for Index stories

Index stories are now supported in the exported EPUB file. Live hyperlinks to indexed terms are displayed in the exported file. The terms retain their references to content at paragraph level.

Export without CSS

While exporting an InDesign document or book to EPUB/HTML, if you decide not to generate the CSS, only the classes associated with the styles are marked in the HTML tags; no overriding classes are created. The exported file is now much cleaner and ready for an external CSS.

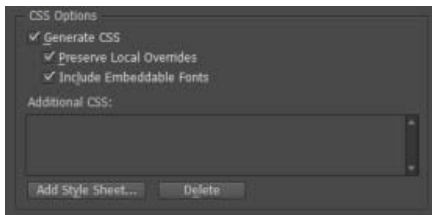

EMIT CSS

The Emit CSS control has been added under the Export Tagging of the Paragraph, Character, and Object Style edit dialogs. If you want to include this style in the CSS, select the Emit CSS check box. If you don't select the check box, no CSS class will be generated for this style. If you have two or more styles having the same class assigned, InDesign displays an error or warning message while exporting.

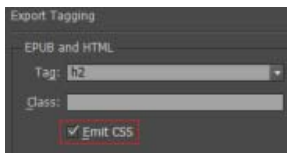

Tidier CSS

To map InDesign attributes with appropriate CSS properties, it is often necessary that we have to generate a sort of "override class" to adjust the behavior of the CSS class generated from the style. Prior to this change, these were given obscure names. These names have now been changed to reflect their purpose and give more clarity to the users regarding the applied overrides.

Object style to export tag mapping

Object Style Options now has the Export Tagging feature. In terms of mapping styles to classes and tags, the object styles now work more like paragraph and character styles.

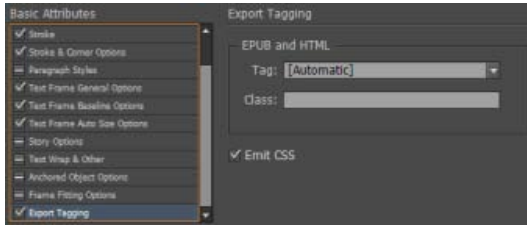

Object export options for object styles

Object Style Options now includes the Export Options for Alt Text, Tagged PDF, and EPUB & HTML. You can specify rasterization settings and custom layout options. Objects with the applied style are handled based on the export options.

For more information, see:

- [InDesign_EPUB_Changes_from-CS6-to-CC \(PDF 1.3 MB\)](#)
- [EPUB enhancements in InDesign CC \(article\)](#)
- [EPUB enhancements \(video\)](#)
- [EPUB gets convert-to-text improvements \(video\)](#)
- [Map object styles to export tags \(video\)](#)

[To the top](#)

Adobe Exchange panel

New in InDesign CC

The new Adobe Exchange panel is now an in-app experience for you to explore and discover content, plug-ins, and scripts that you can purchase or download for free. If you produce scripts, templates, plug-ins, or anything that can enhance the functionality of Adobe's Creative applications, you can quickly package and submit and make them available to a larger community.

Adobe Exchange even lets you privately share products. For example, you can package up a series of images, InDesign templates, and other files. Anyone with who you have privately shared the products can install the content and see any updates you make. The experience is very much like an app store.

You can become a producer for free. Get started here: <https://www.adobeexchange.com/producer>

To open the Exchange panel, go to Windows > Extensions > Adobe Exchange.

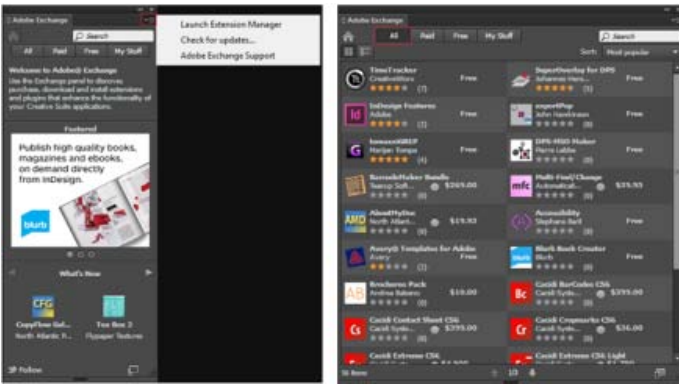

For more information, see [Explore the new Exchange panel \(video\)](#).

[To the top](#)

Other updates

 *Enhanced in InDesign CC*

New document dialog box

The New Document dialog now has the option of showing a preview of the new document. As you select new document options, you see the impact of the selection or changes in the background at the same time.

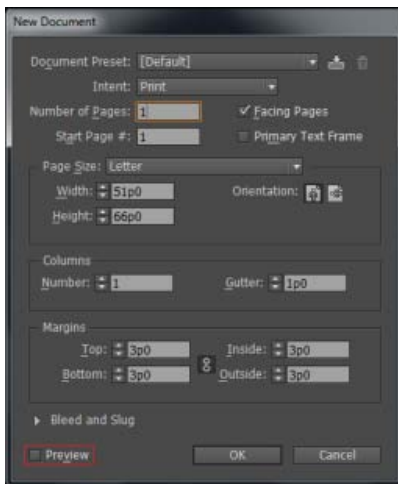

Note: (Chinese, Japanese, and Korean only) The preview option is displayed in the New Layout Grid dialog box (New Document > Layout Grid dialog).

 Twitter™ and Facebook posts are not covered under the terms of Creative Commons.

[Legal Notices](#) | [Online Privacy Policy](#)

What's new in CS6

- [Alternate layouts](#)
- [Liquid layouts](#)
- [Linked content](#)
- [Digital publishing](#)
- [EPUB and HTML5](#)
- [Interactivity](#)
- [Productivity enhancements](#)
- [Language support](#)
- [Extension Manager CS6](#)

Use InDesign to create and publish engaging documents for print, online, or tablet devices. This release contains several enhancements and new features that provide you with pixel-perfect control over design and typography for publishing to all media. With Adobe Digital Publishing Suite, you can design and publish for tablet devices using the familiar InDesign workflows.

Alternate layouts and Liquid Layout page rules, give you the flexibility to design for multiple page sizes, orientations, or aspect ratios.

[To the top](#)

Alternate layouts

Use Alternate Layouts if you require different page sizes for print or digital publishing within the same document. You can use it to create different sizes of a print advertisement. Or to design the horizontal and vertical layouts for devices such as the Apple iPad or Android tablets.

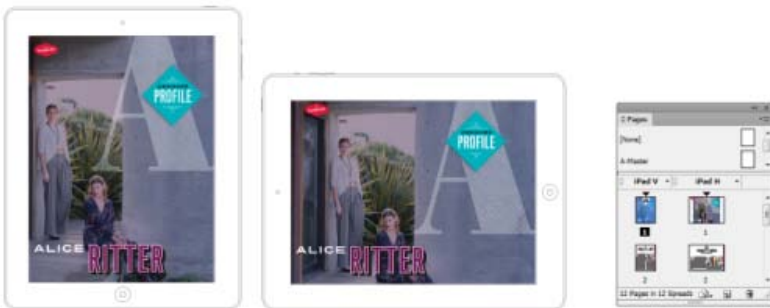

Alternate layouts and the updated Pages panel

Used in combination with Liquid Layout, you can significantly reduce the amount of manual work required to re-layout content for every new page size and orientation. You can also redefine liquid page rules, create links to original stories, automatically copy text styles to a new style group, and activate Smart Text Reflow to repaginate the story in the new page size.

To create an alternate layout, do one of the following:

- Choose Layout > Create Alternate Layout
- Choose Create Alternate Layout from the Pages panel menu

See also

- [Alternate layouts \(video\)](#)

[To the top](#)

Liquid layouts



Liquid Layout

Liquid layouts make it easier to design content for multiple page sizes, orientations, or devices. Apply liquid page rules to determine how objects on a page are adapted when you create an alternate layout and change the size, orientation, or aspect ratio.

Use Liquid page rules to adapt layouts when using the Alternate Layout feature. Select the Page tool  and click a page to select it. Then choose a liquid page rule from the control bar. You can also use the Liquid Layouts panel (Window > Interactive > Liquid Layout).

 Using the Page tool, you can drag the corners and center points of the page to preview the Liquid layout.

For more information see [Alternate layouts \(Article\)](#).



[To the top](#)

Linked content

Use linked content functionality to duplicate page items, and place them on other pages. Both inter-document and intra-document links are supported. You can place and link stories, text frames, page items, interactive objects as well as groups. You can link content, with or without the frames that they are contained in. You can customize the link options to control the update aspects.

While links are useful for all types of publications, they are almost essential when you're working on multi-device publications. Alternate Layouts also use this functionality to link stories in the generated layouts.

To place and link page items, you can use the following:

- Place and Link command (Edit > Place and Link)
- Content Collector  and Content Placer  tools



For more information see [Linked content](#).

For a quick overview, see [Linked content](#) video by Lynda.com.

Content collector and placer tools

Content Collector and Placer tools let you duplicate objects and place them on open InDesign documents. As content is collected, it is displayed in the Content Conveyor. Use Content Conveyor to easily and quickly place and link multiple page items within and across any open documents.

Click  in the toolbox to open the Content Conveyor.

- Use Content Collector tool  to select an item and add it to the conveyor
- Use Content Placer  to place page items on a page

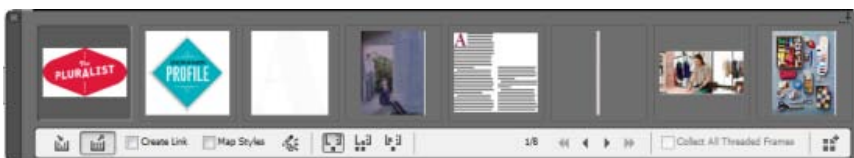

Content Conveyor

See also

- [Content Placer tools \(video\)](#)

Custom style mapping

Text styles (paragraph, character, table, cell) or style groups can be mapped to different styles while linking. In the Link Options dialog box (Links panel > Link Options), enable Define Custom Style Mapping and then click Settings.

Custom style mapping comes in handy, for example, when you want to use sans serif fonts for digital and serif fonts for print publications. Or if you want, vary the text style between the horizontal and vertical layouts.

In the Link Options dialog box, enable Define Custom Style Mapping and then click Settings.

For more information, see [Content Placer tools \(Article\)](#).

Preserve local edits

Use Preserve Local Edits option to modify linked content. Often, you would like the linked item to differ slightly from the original item. For example, if you place an image and then resize the frame or add a stroke to the frame, you can preserve these changes on updating the link.

In the Link Options dialog box (Links panel menu), select the options under preserve local edits.

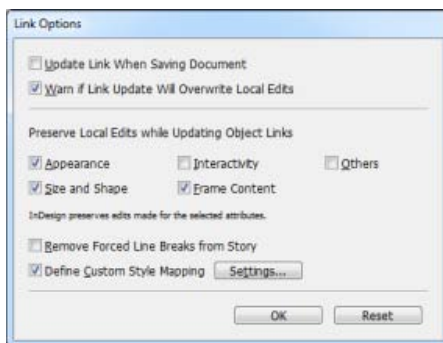

For more information, see [Custom style mapping](#).

[To the top](#)

Digital publishing

New document presets

In addition to the Web and Print intents, you can specify Digital Publishing intent while creating a document (File > New). You can specify sizes (including custom sizes) and orientations for several common devices. When you choose the Digital Publishing intent, page size is set to that of the chosen device size in pixels. The Primary Text Frame option is also enabled.

If you want more control on device size and orientation, create a Document Preset or specify a custom page size.

Primary text frame

You can now designate a text frame on the master page as the primary text frame. When you apply a new master page to a layout page, the story in the primary text frame flows into the primary text frame. Primary Text Frames are automatically overridden on layout pages, so that you no longer need to override them before adding text.

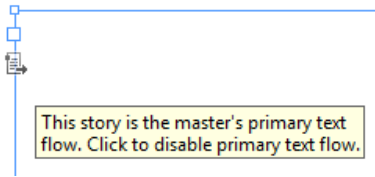

Primary text frame indicator

To designate a primary text frame, open a master page and do one of the following:

- Click the symbol near the left-upper corner of the text frame
- Right-click on text frame and choose Primary Text Frame

Note: Only a single text frame can be designated as primary on a master page.

Text frame fitting options

Flexible width columns

You can use the Flexible width option to adjust the number and width of columns as the text frame is resized. Columns are automatically added or deleted when the maximum column width is reached as the text frame is resized.

Choose Flexible Width from the Columns drop down list in the Text Frame Options dialog box (Object > Text Frame Options)

Persistent text frame fitting options

Auto-size text frame options make it possible to set up a text frame so that it is automatically resized when you add, delete, or edit text.

To access the Auto-size options, do the following:

1. Select a text frame and choose Object > Text Frame Options
2. Click Auto-size.

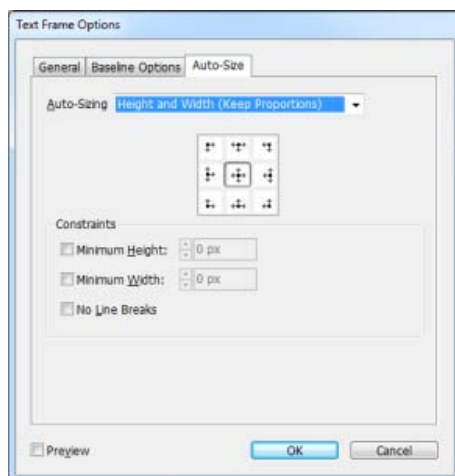

Auto Size options

Packaging and preflight

The Package functionality (File > Package) now includes Digital Publishing Suite assets in Folio Overlays. If you've placed links from other InDesign documents, they are included as well.

Additional preflight profile for Digital Publishing is also available (Window > Output > Preflight).

Discoverable Folio Builder and Folio Overlay panels

The Folio Builder and Folio Overlay panels are located under the Window menu.

- **Folio Builder:** Choose Window > Folio Builder
- **Folio Overlay:** Choose Window > Folio Overlay

Note: In InDesign CS5.5, Folio Overlay panel was called Overlay Creator, and these panels were available under the Windows > Extensions menu.

Digital publishing workspace

Use the Digital Publishing workspace to display all the tools and panels required for working on digital publications. Select Digital Publishing workspace from the workspace switcher in the Application bar.

[To the top](#)

EPUB and HTML5

EPUB Export workflows have been simplified, and you can now choose an EPUB version to export to. The Export to EPUB dialog box has been reorganized and simplified.

Watch this video by Lynda.com for a quick overview of how to [Export to EPUB](#).

EPUB2 enhancements

Several enhancements were made in the EPUB2 export in InDesign CS6, to provide better control and efficiencies while export. EPUB2 remains the most dominant EPUB standard with a majority of devices and readers supporting it.

- Specify options to float a frame either left or right. These options can be specified using the Object Export Options.
- Additional inline and anchored text frame attributes are translated to the CSS: Size, border style and width, fill color, padding (inset on text frame), and margin (on text wrap)
- Specify different values for each margins in an EPUB
- Link to multiple custom CSS files
- Split an EPUB into smaller files based on export tags specified in paragraph styles.
- New XHTML document is created when you link to an external eBook cover file
- Support for converting InDesign table cell styles to CSS in the exported EPUB
- EPUB table dimension includes attributes for column width and row minimum height
- InDesign custom bullet and numbering marker strings now exported in EPUB
- Added support for Japanese Ruby: font, size, and color

EPUB3

IDPF approved the [EPUB3 standard](#) in October, 2011. This format supports, among others, audio, video, JavaScript, and japanese vertical text. EPUB3 export for InDesign supports the following:

- EPUB3 package format
- Linking to multiple external JavaScripts
- Vertical Japanese text

- Audio and video tags
- Placed HTML and Adobe Edge HTML animations during export

For more information see, [Export content for EPUB](#).

NOTE: EPUB3 validators may report errors if placed HTML or HTML animations are not fully XHTML-compliant. However, EPUB3 viewers may still function correctly. Adobe Systems cannot guarantee how placed HTML or Adobe Edge animations will perform in third-party EPUB3 viewers.

EPUB3 with layout

EPUB3 with Layout is an experimental format that builds on the EPUB 3.0 specification. Support for alternate and adaptive layouts including: multiple columns, text wrap, and liquid layouts has been added. Using this technology it is possible to create true adaptive layouts that look good on all devices and screen sizes and minimizes autoflow issues.

Adobe has submitted this technology to the IDPF for consideration as an extension of the EPUB3 specification. At the time of CS6 launch, there are no publicly available EPUB viewers that support this feature.

HTML

Enhanced Export to HTML supports the following:

- External CSS files for style information
- Fallback support using Adobe Flash Player for placed video
- Placed HTML and Adobe Edge animations
- Linking to multiple custom CSS files
- Linking to multiple custom external javascripts

[To the top](#)

Interactivity

Create PDF forms

You can design forms in InDesign and export them directly to PDF. InDesign now supports form fields and additional form actions. The Buttons and Forms library (Window > Interactive > Buttons and Forms) contains items that you can use to design interactive forms. You can also specify tab orders and tool tips without post-processing in Adobe Acrobat. Accessibility tags are also added to the exported PDF form.

Watch [Create PDF forms](#) video by Lynda.com for a quick overview.

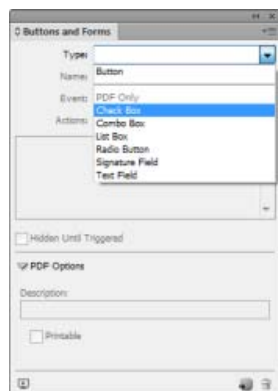

Buttons and Forms panel with PDF form components

1. Choose Window > Interactive > Buttons and Forms to display the form components, and place them on the page. You can then modify them as desired, with custom labels, different colors, or different sizes.

2. From the Buttons and Forms panel, choose Actions to apply a form action to the form fields.

For more information on adding form fields and specifying tab order, see Forms.

Export interactive PDF as pages

You can now export interactive PDFs as either spreads or pages. In the Export to Interactive PDF dialog box (File > Export), choose either Pages or Spreads. The default selection is spreads.

Place Adobe Edge designs

Use the new Adobe® Edge web motion and interaction design tool to bring animated content to websites, using web standards like HTML5, JavaScript, and CSS3. You can place an Adobe Edge package on your layout to add interactivity and animation to your Folio or HTML export.

- Choose File > Place and navigate to the file (.OAM) to place it. The design is placed and InDesign fetches a poster image.

When you preview the folio or export to HTML, the placed Edge design plays.

 Older versions of Adobe Edge do not support exporting to OAM. Zip the output folder and rename the extension to OAM.

Embed HTML snippets

You can embed common HTML elements, such as embed codes for YouTube videos or Google Maps. You can copy the HTML embed code and paste it into InDesign.

- Choose Object > Insert HTML, and paste the HTML code
- Copy the code to the clipboard and paste it on your layout

InDesign automatically fetches a poster image. The embedded object is not interactive in the InDesign layout. Export the layout to HTML or preview the folio (File > Folio Preview) to interact with the object.

[To the top](#)

Productivity enhancements

Split window

To compare two different layouts in the same document, you can split the active window. Use the two panes to view alternative layouts side by side.

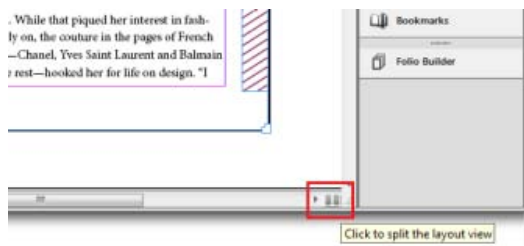

Split layout view

- Click the button in the lower-right corner of the document window
- Choose Window > Arrange > Split Window
- From the Layout menu in the Pages panel, choose Split Window to Compare Layouts

Recently used fonts

To find fonts easily and reduce scrolling, view the recently used fonts at the top of the Font pop-up and Type > Fonts menus.

- Specify the number of recent fonts to display under Edit > Preferences > Type > Number of recent fonts to display.
- By default the recently used fonts are displayed in chronological order. To display them in alphabetical order, choose Edit > Preferences > Type > Sort Recent Fonts List Alphabetically.

Align to key object

An additional option is available for distributing objects in the Align panel.

1. Select the objects to distribute, and in the Align panel (Windows > Align) choose Align To Key Object from the Align To list.
2. The key object appears with a thick border. Click another object to select it as the key object.

Save backward to earlier versions

To open an InDesign document in a previous version, or to send it to someone who has not upgraded yet, save the document in the InDesign Markup Language (IDML) format. IDML files are supported by InDesign CS4 or later. Features not supported by the earlier version will not work.

The option to save documents to earlier versions is now available from the Save and Save As dialog boxes.

1. Choose File > Save As
2. From the Save As Type list, select InDesign CS4 or later (IDML)

Export and proof grayscale PDFs

You can now proof and export designs as grayscale PDFs. For example, use this feature to quickly export your layout for grayscale printing. The digital publication remains full color, and you can avoid maintaining separate layouts for grayscale and color outputs.

Use Proof Setup (View > Proof Setup) to specify grayscale proof options, and choose a Dot Gain or Gamma destination. After you've setup the proof, choose View > Proof Colors to toggle between grayscale and color output.

You can also export a grayscale PDF from within InDesign. All page items, irrespective of their original color space, are converted to grayscale while exporting to PDF.

1. Choose File > Export and select Adobe PDF (Print).
2. In the export options dialog box, click the Output tab.
3. Under Color Conversion, choose Convert To Destination.
4. Under Destination, choose a Dot Gain or Gray Gamma destination.

Note: Grayscale destinations are not available under the PDF/X-1a standard. The standard supports only CMYK intents. Similarly, PDF/X-2 or PDF/X-3 standards do not support Gamma Gray destinations.

Complex calculations in panels and dialog boxes

You can now perform complex calculations within the text fields in panels and dialog boxes. Enter a mathematical expression using mathematical operators, for example, $120p0/2 + 10$.

Export to PNG

To export a selection or a range of pages as an image, choose File > Export and then select PNG from the Save As Type list. Use the Export Options dialog box to specify what to export and the export settings.

Export enhancements

- SWF Export: The Export Options dialog box displays Font license information.
- Export For: The File > Export For menu has been removed. All supported options are consolidated in the Save As Type list in the Export dialog box.
- Options for exporting to Buzzword, SVG and SVG compressed are no longer available.

[To the top](#)

Language support

Adobe World-Ready composers and support for open-source HunSpell dictionaries enable you to use several additional languages using InDesign.

Placeholder text with specified alphabet

You can enter placeholder text Roman, Arabic, Hebrew, Chinese among others.

To specify the language of placeholder text, press Ctrl (Windows) or Command (Mac OS) when you choose Type > Fill With Placeholder Text. In the Fill Options dialog box, choose an alphabet and click OK.

HunSpell enhancements

For most languages, InDesign ships with open-source HunSpell dictionaries and HunSpell is the default dictionary provider. You can download and install additional spelling and hyphenation dictionaries for other languages from the [OpenOffice website](#).

To use InDesign with additional languages, choose Edit > Preferences > Dictionary and then click HunSpell Info.

Indic support

Adobe World-Ready Composer (WRC) provides correct word shaping for many of the non-Western scripts, such as Devanagari. Adobe World-Ready composers in the International English version of InDesign, support several Indian languages including Hindi, Marathi, Gujarati, Tamil, Punjabi, Bengali, Telugu, Oriya, Malayalam, and Kannada.

Hunspell spelling and hyphenation dictionaries are included, and so is the Adobe Devanagari font family.

Enable the Adobe World-Ready Composer through a paragraph style (Paragraph Style > Justification > Composer) or using the Paragraph panel menu.

Set Indic preferences to work on Indic scripts, and correctly import content into InDesign.

1. Choose Window > Utilities > Scripts
2. Double-click `indicPreferences.js`
3. Open a new document or restart InDesign

Middle Eastern support

InDesign CS6 is also available in Middle Eastern and North African editions. It adds support for Arabic and Hebrew, and provides several features for working with right-to-left, bi-directional scripts, and other language-specific features. Enhanced functionality includes support for tables in the Story Editor, improved Kashida justification, enhanced diacritic positioning, and other text-handling improvements.

See [Working with Arabic and Hebrew](#) for more details.

Extension Manager CS6

With Extension Manager CS6, you can create, edit, activate, import, and export extension sets. Extension Manager CS6 supports the following:

- User-level extension installation
- Search and filter extensions
- MXP to ZXP conversion
- Extension dependency support
- Installing extensions when multiple languages of a product are installed
- Display additional extension information

For more information on using Extension Manager CS6, see [Extension Manager CS6](#)



Twitter™ and Facebook posts are not covered under the terms of Creative Commons.

[Legal Notices](#) | [Online Privacy Policy](#)

Sync Settings using Adobe Creative Cloud | CC

What's covered?

[Introduction](#)

[Sync settings at first launch](#)

[Using the sync settings feature](#)

[Sync settings on successive launches](#)

[Managing sync](#)

[What's not supported](#)

[To the top](#)

Introduction

When you work on multiple computers, managing and syncing glyph sets, menu customizations, keyboard shortcuts, custom workspaces, and PDF presets among the computers could be a chore.

The new Sync Settings feature enables individual users to sync their settings using Creative Cloud. If you use two computers, for example, one at home and another at work, the Sync Settings feature makes it easy for you to keep those settings synchronized on these two computers. Also, if you have replaced your old computer with a new one and have reinstalled InDesign, you can get the application set up quickly with all your settings in place by just pressing a button.

Note: *At any given time, you can activate InDesign on two computers only.*

The syncing happens via your Adobe Creative Cloud account. All the settings are uploaded to Creative Cloud and then are downloaded and applied on the other computer.

All sync operations are initiated by users. They cannot be scheduled or performed automatically (such as at launch or during shutdown).

Prerequisites for this feature to work:

- Computers should be connected to the Internet.
- You have signed into your Adobe Creative Cloud account on both computers.

[To the top](#)

Sync settings at first launch

After installation, when you launch the application and create a document or open an existing document for the first time, you will see a prompt asking whether you want to start the sync.



- Click **Sync Settings Now** to initiate the sync.
- Click **Disable Sync Settings** to disable the feature.
- Click **Advanced** to open the Preferences dialog, where you can choose and customize what items are synchronize.

[To the top](#)

Using the sync settings feature

Do any one of the following:

- [Recommended] Click the Sync Settings icon (🔄) at the lower-left corner of the InDesign active document window, and then click **Sync Settings Now**.
- Click **Edit (Mac: InDesign) > {AdobeID logged in} > Sync Settings Now**.

[To the top](#)

Sync settings on successive launches

When you launch InDesign with prior sync information available, and create a document or open an existing document for the first time, you will see a prompt asking whether you would like to sync the setting from the cloud. To initiate the sync, click **Sync Settings Now**.



The settings are downloaded to your local computers and are updated in the application. If you change glyph sets, keyboard shortcuts, custom workspaces, or PDF presets, you should initiate sync before you close the application. You can see the sync status in the left-bottom corner of the document status bar. Click the Sync Settings icon (🔄) in the status bar and then click **Sync Settings Now**.

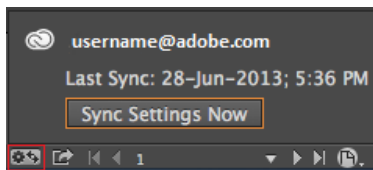

[To the top](#)

Managing sync

What gets synced

- Workspaces
- Menu sets
- PDF presets
- Keyboard shortcuts
- Glyphs sets

Choose what you want to sync

Navigate to the Preferences > Sync Settings tab:

- Click **Edit (Mac: InDesign) > {AdobeID logged in} > Manage Sync Settings**.
or
- Click **Edit (Mac: InDesign) > Preferences > Sync Settings**.

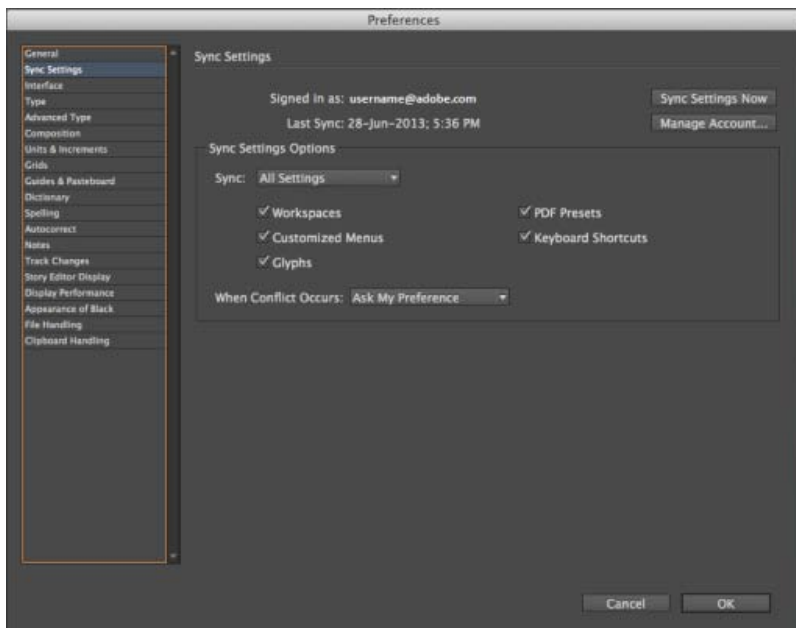

Select the checkboxes for the settings that you want to sync. You can also choose what to do in case of conflict.

Note: To sync your settings successfully, you must change the settings only from within the application. The sync settings feature does not sync any file that is manually placed in a folder location.

Choose an option in case of conflict

There are situations when the system could detect sync conflicts. Sync conflicts occur when the system is unable to determine whether you want a setting from Creative Cloud or from your local computer to be retained since both have been changed after the last sync operation.

Suppose that you change PDF presets on your work computer and sync settings to the Cloud. You then go home and change the same presets on your home computer without syncing with the cloud first. Now since the settings in the cloud and the settings on your home computer are both updated, conflict occurs when you try to sync. If you try to sync in this state, you see a conflict prompt.

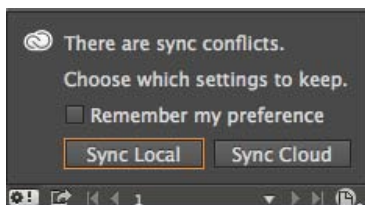

- Sync Local: Sync local settings on this computer to the cloud; overwrite the cloud version with the local version of settings.
- Sync Cloud: Sync from the cloud to this local computer; ignore changes made to the local settings and replace them with the settings in the cloud.

[To the top](#)

What's not supported

- Keyboard shortcuts created for Windows will only sync with a Windows computer. Mac keyboard shortcuts will only sync with a Mac computer.
- Assets saved to a custom location are not synced.
- Any modifications (for example: rearrangement of panel) made after creation of the Workspace will not be synced. For Workspace syncing,

first set up your working environment and then create a workspace and initiate the sync process.

 Twitter™ and Facebook posts are not covered under the terms of Creative Commons.

[Legal Notices](#) | [Online Privacy Policy](#)

EPUB enhancements in InDesign CC

- [Style to class name mapping](#)
- [Style class ownership - handling of CSS class name collisions](#)
- [Clean markup for Ordered/Numbered Lists](#)
- [Improved heuristic for determining bullet and numbering structure](#)
- [Static ordered list removed from EPUB export](#)
- [Improved HTML markup and CSS for Convert To Text list Export option](#)
- [Version string metadata](#)
- [Improved naming convention of CSS classes to match their purpose](#)
- [CSS generated for Japanese ruby tag](#)
- [Scripting support for EPUB book export](#)
- [New export warning or error message dialog](#)
- [Improved mapping of bullet character to list-style-type property](#)
- [Break-before property mapping](#)
- [Access to iBooks reader device fonts](#)
- [Font embedding on iBooks reader now supported](#)
- [‘EPUB 3.0 with Layout’ option removed from EPUB export](#)
- [Mapping paragraph keeps attributes to CSS paragraph properties](#)
- [Support for more than one CSS class name in 'Style To Tag/Class' fields of paragraph, character, and object styles](#)
- [Empty <p> and ranges are removed](#)

[To the top](#)

Style to class name mapping

While generating a class name from a style name, InDesign now generates a fully qualified class name: <style group name>_<style name>.

[To the top](#)

Style class ownership - handling of CSS class name collisions

If you map two styles to the same class name, it results in a conflict when you decide to generate the CSS for the associated document. InDesign now flags a warning and displays a message about the conflict while exporting.

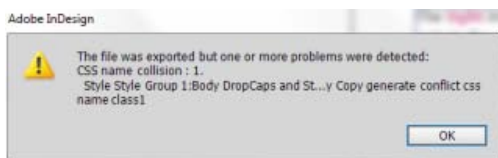

[To the top](#)

Clean markup for Ordered/Numbered Lists

The generated markup for “Map to Unordered List” and “Map to Ordered List” options under the EBook Export > General > Text Options are now free from any extra classes. InDesign no longer inserts any characters or creates any spans, and lets the browser or device be responsible for composing the lists.

[To the top](#)

Improved heuristic for determining bullet and numbering structure

The heuristic for determining bullet and numbering structure has been improved significantly to detect the semantic structure of the bullets and numbers, and properly expressing it in the HTML.

For bullets:

- InDesign treats two paragraphs which share ALL the same bullet related attributes, including left indent, as being part of the same list.
- A paragraph which is not a bullet but follows a bullet paragraph and has the same left indent, is now considered a “nested” paragraph and becomes part of the list.

For numbers:

- As designers can set the attribute for the “List” that it is part of, this setting has the highest priority relative to left indent or different number related attributes.
- Although InDesign supports setting the value attribute on the tag, it is not possible to express a numbered list, which crosses Table and Story boundaries, in HTML.

For correct numbering, export to EPUB 3.0.

[To the top](#)

Static ordered list removed from EPUB export

As InDesign now offers a true (stripped) markup to lists respecting the starting number values, the Static Ordered List option is removed from the EPUB Export dialog.

[To the top](#)

Improved HTML markup and CSS for Convert To Text list Export option

The HTML markup and CSS of the “Convert To Text” export option has been improved. InDesign now inserts necessary bullet or number characters and overrides styling so that the overall look of the list option remains close to how it looks in InDesign.

[To the top](#)

Version string metadata

Version number has been added to the generator metadata:

```
<meta name="generator" content="Adobe InDesign 9.0" />
```

[To the top](#)

Improved naming convention of CSS classes to match their purpose

InDesign generates various extra classes for the purposes of improving the visual fidelity and conceptual mapping between InDesign and EPUB.

The classes are now renamed to match and clarify their purpose.

Generated CSS Class Prefix	Description
CharOverride-#	Mapping of user applied Character Attribute override to CSS properties
ParaOverride	Mapping of user applied Paragraph Attribute override to CSS properties
TableOverride-#	Mapping of user applied Table Attribute override to CSS properties
CellOverride-#	Mapping of user applied Cell Attribute override to CSS properties
ObjectOverride-#	Mapping of user applied Object (PageItem) Attribute override to CSS properties

_idGenParaOverride-#	Deal with CSS property inheritance (such as left indent)
_idGenCharOverride-#	Deal with CSS property inheritance (such as point size)
_idGenDropcap-#	Make the Dropcap look more like ID
_idGenBNMarker-#	Make the Bullet & Number characters look more like ID
_idGenRuby-#	Alter the Ruby CSS
_idGenStoryDirection	Support story direction
_idGenTableRowColumn	Support alternating table strokes and fills
_idGenPageitem-#	Carry the width and height of the PageItem/Object

[To the top](#)

CSS generated for Japanese ruby tag

InDesign now generates a separate CSS rule containing just the ruby related attributes.

[To the top](#)

Scripting support for EPUB book export

The scripting support was not available in CS6, and it is available now.

[To the top](#)

New export warning or error message dialog

The new dialog makes it easier to read multiple warning or error messages from the export.

[To the top](#)

Improved mapping of bullet character to list-style-type property

If any Unicode value is found other than the listed ones in the table below, the CSS will not specify it and leave it to the device or browser default (typically “disc”).

ID Unicode value	CSS Property
0x2022 (bullet)	“disc”
0x25CB (white circle)	“circle”
0x25A0 (black square)	“square”

The various InDesign numbered list types are now mapped to the CSS properties as listed in the table below.

ITextAttrNumberingStyle	CSS Property
1,2,3,4	“decimal”
01,02,03,	“decimal--leading--zero”
I, II, III,	“upper--roman”
i, ii, iii,	“lower--roman”

A,B,C,D	“upper--alpha”
a,b,c,d	“lower--alpha”
001,002,003,	“decimal--leading--zero”
0001,0002,0003,	“decimal--leading--zero”

[To the top](#)

Break-before property mapping

The Keeps Option “Start Paragraph” attribute is now mapped correctly to a valid CSS property. Any value for this attribute other than ‘kStartAnywhere’ is mapped to ‘pagebreak-before:always’.

Break characters remain unsupported at this time.

[To the top](#)

Access to iBooks reader device fonts

iBooks Reader supports a wide number of device fonts (<http://iosfonts.com/>), and these fonts are not enabled by default when referenced via `@font-face` unless the special XML option file `META-INF/com.apple.ibooks.display-options.xml` is added to the package.

Now the option file is added to both the EPUB2.0 and EPUB3.0 packages.

[To the top](#)

Font embedding on iBooks reader now supported

EPUBCheck has been changed to accept the embedded font format as being acceptable for iBooks Reader.

[To the top](#)

‘EPUB 3.0 with Layout’ option removed from EPUB export

As the DPS Reader has decided not to support this format, the ‘EPUB 3.0 with Layout’ option is removed from the EPUB Export dialog box.

[To the top](#)

Mapping paragraph keeps attributes to CSS paragraph properties

Paragraph Attribute	CSS Property
Keep With Previous	page-break-before:avoid
Keep All Lines Together	orphans: 99
Keep First N	orphans: #
Keep Last N	window: #
Keep With Next N	page-break-after:avoid

In a previous change, the Start Paragraph was mapped to the CSS property ‘page-break-before:avoid’. Since this attribute and Keep With Previous share the same mapped property, in cases of conflict, the Start Paragraph will win, as it does in InDesign.

Note: Mapping of Keep With Next N ignores any values other than one. Also, break characters (goto Next N) remain unsupported at this time.

Support for more than one CSS class name in 'Style To Tag/Class' fields of paragraph, character, and object styles

Multiple Class names must be separated by one or more spaces, and the first Class name will be used to generate the CSS for Style, if Emit CSS is enabled for this Style.

For example, a Paragraph Style that says:

Class: InDesign is the best

Results in:

```
<p class="InDesign is the best">foo</p>
```

```
p.InDesign {...}
```

The intention of this feature is to allow designers to override or extend CSS properties via the “Additional CSS File” mechanism in the Advanced tab of the EPUB Export dialog.

No additional checking is done for the values specified and during export InDesign simply carries them along for the purposes of markup and otherwise ignores them.

Empty <p> and ranges are removed

Empty Paragraphs in InDesign are not empty – they contain a carriage return and are composed with vertical height.

In HTML, InDesign maps Paragraphs to <p> and tags as appropriate and the carriage return is not part of the mapping that can lead to empty tags.

 Twitter™ and Facebook posts are not covered under the terms of Creative Commons.

[Legal Notices](#) | [Online Privacy Policy](#)

InDesign getting started tutorials

[What is InDesign CC](#)

Adobe TV (Jun. 17, 2013)

video-tutorial

Learn about Adobe InDesign, the industry-standard publishing application for print publications, interactive PDF documents, digital magazines, and EPUBs.

[Learn InDesign CC video tutorials](#)

Adobe TV (Jun. 17, 2013)

video-tutorial

Learn the basics of InDesign CC with Getting Started and New Features tutorials by product experts.

[10 Things Beginners Want To Know How To Do in InDesign CC](#)

Terry White (Nov. 26, 2012)

video-tutorial

Terry will demonstrate 10 things beginners want to know how to do in Adobe InDesign CC.

[Linking Content](#)

Anne-Marie Concepcion (May. 15, 2012)

video-tutorial

Watch this video tutorial to learn how to create and update links between objects in the same document and others.

[Printing booklets using your desktop printer](#)

Jeff Witchel (Oct. 15, 2012)

video-tutorial

Learn how to create a booklet and print it using your desktop printer

[Creating and saving your own workspace](#)

Jeff Witchel (Oct. 15, 2012)

video-tutorial

Learn how to personalize the workspace

[Layers magazine video tutorials](#)

video-tutorial (Aug. 1, 2012)

Visit Layers Magazine, to see the latest InDesign tutorials.

[Applying guide-based Liquid Layout rules](#)

Anne-Marie Concepcion (May. 15, 2012)

video-tutorial

Learn how guide-based Liquid Layout rules work, and how to create liquid guides and ruler guides.

[Applying object-based Liquid Layout rules](#)

Anne-Marie Concepcion (May. 15, 2012)

video-tutorial

Discover how the object-based Liquid Layout rules work, both on-object and via the Liquid Layout panel.

[Building a Newsletter](#)

Kelly McCathran (May. 15, 2012)

video-tutorial

This tutorial shows how to create a newsletter, which is one of the easiest, most inexpensive ways to reach customers and colleagues or connect with family.

[Creating a Letterhead](#)

Kelly McCathran (May. 15, 2012)

video-tutorial

Letterhead is fundamental for branding, in this InDesign tutorial we will build one from scratch, complete with guides, logo, and contact

text.

[Creating and previewing a basic form](#)

Anne-Marie Concepcion (May. 15, 2012)

video-tutorial

A tutorial to show how to create a simple form using most of the different types of fields available in InDesign.

[Exporting to EPUB 3 and fixed layout](#)

Anne-Marie Concepcion (May. 15, 2012)

video-tutorial

This video demonstration helps you learn about the new EPUB3 option in the Export EPUB dialog box.

[Reviewing the Forms tools](#)

Anne-Marie Concepcion (May. 15, 2012)

video-tutorial

An overview of the form field-related buttons, dialog boxes and menu commands in InDesign. Compare the old and new ways of creating interactive forms.

[Testing a form in Acrobat](#)

Anne-Marie Concepcion (May. 15, 2012)

video-tutorial

This tutorial shows you how InDesign form fields look in Acrobat or Reader. Then, learn how to continue modifying the interactive fields in Acrobat for additional functionality, and how the form performs in Acrobat.

[Understanding Liquid Layout rules](#)

Anne-Marie Concepcion (May. 15, 2012)

video-tutorial

This tutorial defines and demonstrates Liquid Layout, and tours the location of Liquid Layout-related commands and dialog boxes.

[Using Content Collector and Content Placer tools](#)

Anne-Marie Concepcion (May. 15, 2012)

video-tutorial

Learn about the Content Collector and Content Placer tools. See how to use the Conveyor and most of its options, such as navigating and drilling down into groups.

[Using advanced EPUB 2 export controls](#)

Anne-Marie Concepcion (May. 15, 2012)

video-tutorial

This tutorial discusses the new paragraph style option for splitting a document for EPUB export.

[Using basic Liquid Layout rules: Scale, Recenter, and Based on Master](#)

Anne-Marie Concepcion (May. 15, 2012)

video-tutorial

Discover how to apply None, Scale, and Recenter rules when resizing a layout. Also learn the meaning behind "Based on Master."

[What is InDesign CS6?](#)

Adobe TV (May. 15, 2012)

video-tutorial

Learn about Adobe InDesign, the industry-standard publishing application for print publications, interactive PDF documents, digital magazines, and EPUBs.

[Working with Alternate Layouts](#)

Anne-Marie Concepcion (May. 15, 2012)

video-tutorial

Learn how to use Alternate Layouts for both print and digital publishing.

[Working with Frames](#)

Kelly McCathran (May. 15, 2012)

video-tutorial

Everything that is placed into InDesign ends up in a frame. You can create frames from scratch, or if you "place" (import) text or images into a document, InDesign automatically creates the frame for you.

[Working with Graphics](#)

Kelly McCathran (May. 15, 2012)

video-tutorial

In this video you'll learn about placing, which is how you import photos or text into your InDesign page. We'll go over the popular image formats: PSD, AI, PSD, TIFF, and JPEG. You will also see how to scale, center, and crop photos.

[Working with Tools](#)

Kelly McCathran (May. 15, 2012)

video-tutorial

The InDesign toolbar contains a lot of tools, many of which are hidden or "nested" underneath the tools you see initially. In this video you will see the primary tools used to select, rotate and size objects. You'll also learn how to use the Type tool to edit text and create frames with or without borders, switch tools using your keyboard, and navigate with the Hand and Zoom tools.

[Build digital magazines with InDesign CS5.5 and Adobe Digital Publishing Suite \(video 09:06\)](#)

Terry White (May. 7, 2012)

video-tutorial

In this video, see you how to create immersive digital magazines for tablet devices using InDesign.

[Create more compelling eBooks with InDesign CS5.5 \(video 16:11\)](#)

Terry White (May. 7, 2012)

video-tutorial

In this video, see the new features in InDesign CS5.5 - including linked text, articles panel, and the ability to embed audio and video – that will help you design more engaging eBooks than ever before.

[Learn InDesign CS6 video tutorials](#)

Adobe TV (May. 7, 2012)

video-tutorial

Learn the basics of InDesign CS6 with Getting Started and New Features tutorials by product experts.

[Using the Links panel \(video 5:23\), CS4-CS6](#)

Michael Ninness (Jan. 2, 2011)

video-tutorial

Watch and learn how to customize the Links panel to suit your needs.

[Adding audio and video content to EPUB \(video 02:46\)](#)

Colin Fleming (Jan. 1, 2011)

video-tutorial

In this video tutorial, see how simple it is to embed audio and video content in InDesign CS5.5 and later, for export to EPUB.

[Adobe Creative Suite 5/5.5 Printing Guide \(PDF, 21 MB\)](#)

article (Jan. 1, 2011)

Download this guide to learn how to set up Adobe documents for print. All the information you need for professional printing in one place.

[Applying GREP styles \(video 4:46\)](#)

Michael Ninness (Jan. 1, 2011)

video-tutorial

This video tutorial shows you how to apply a character style to any text that matches the GREP expression you specify. Make the GREP style part of a paragraph style.

[Building a grid of objects quickly \(PDF, 100 KB\)](#)

article (Jan. 1, 2011)

Tutorial to build a grid of objects in InDesign CS5 and later.

[Classroom in a Book](#)

Adobe Press (Jan. 1, 2011)

article

This completely revised CS6 edition covers the new tools for adding PDF form fields, linking content, and creating alternative layouts for digital publishing. The companion CD includes all the lesson files that readers need to work along with the book.

[Controlling order of content export from InDesign to EPUB without changing your layout \(video 04:54\)](#)

Colin Fleming (Jan. 1, 2011)

video-tutorial

Learn how to create and organize articles in the Articles panel for export to EPUB, without changing layout or writing code.

[Creating accessible PDF documents \(PDF, 2.6 MB\)](#)

article (Jan. 1, 2011)

[Creating and editing motion presets \(video 5:23\)](#)

Anne-Marie Concepcion (Jan. 1, 2011)

video-tutorial

See how to edit and customize motion path presets, which allow you to animate images or text in InDesign.

[Creating conditional text \(video 6:48\), CS4-CS6](#)

David Blatner (Jan. 1, 2011)

video-tutorial

Learn how to use conditional text in InDesign.

[Creating covers and title pages for EPUB \(video 05:50\)](#)

Colin Fleming (Jan. 1, 2011)

video-tutorial

Learn how to create covers and title pages for your EPUB titles.

[Creating cross-references \(video 5:45\), CS4-CS6](#)

David Blatner (Jan. 1, 2011)

video-tutorial

Walk through the procedure of adding cross-references. Create cross-references that can be updated quickly when the target text or pagination changes. Create a custom cross-reference format.

[Creating documents with Interactive features \(video 8:06\)](#)

Anne-Marie Concepcion (Jan. 1, 2011)

video-tutorial

Learn how to use the Media panel, the Preview panel, and the Timing panel to determine what happens when.

[Creating interactive documents in a snap \(PDF, 201 KB\)](#)

article (Jan. 1, 2011)

A handy tutorial on how to add interactivity to your documents.

[Creating multistate objects \(PDF, 203 KB\)](#)

article (Jan. 1, 2011)

This short tutorial shows you how to create multi-state objects to add interactivity.

[Creating rich interactive documents \(PDF, 6.7 MB\)](#)

article (Jan. 1, 2011)

Learn how to create rich interactive documents using InDesign.

[Document installed fonts \(video 2:29\)](#)

Michael Ninness (Jan. 1, 2011)

video-tutorial

Learn how to use document installed fonts in your designs, in InDesign CS5 and later.

[Enhanced eBook Authoring \(video 1:10\)](#)

video-tutorial (Jan. 1, 2011)

Watch a quick a over view on the EPUB capabilities in InDesign CS5.5.

[Exploring new FLA export options \(video 6:26\)](#)

Anne-Marie Concepcion (Jan. 1, 2011)

video-tutorial

See how to publish your InDesign project in a variety of Flash formats by using the enhanced Export dialog box in InDesign CS5 and later.

[Exporting documents to EPUB \(PDF, 265 KB\)](#)

article (Jan. 1, 2011)

A short and quick overview on how to export your layouts to EPUB in InDesign CS5.

[Exporting to EPUB for the Apple iBookstore \(PDF, 2.5 MB\)](#)

article (Jan. 1, 2011)

Learn how to create an EPUB for the Apple iBook store

[Folio Producer Tools \(video 1:04\)](#)

video-tutorial (Jan. 1, 2011)

An very short overview of Folio Producer tools for Digital Publishing.

[Generating image captions with metadata \(PDF, 148 KB\)](#)

article (Jan. 1, 2011)

A short tutorial on how to work with medata and auto-generate captions for images in your layout.

[Grid Mode and Live Distribute \(video 2:48\)](#)

Michael Ninness (Jan. 1, 2011)

video-tutorial

Watch how you can quickly create grids on the fly using design tools that are "gridified".

[Layers panel \(video 2:59\)](#)

Michael Ninness (Jan. 1, 2011)

video-tutorial

See how the all new Layers panel lets you manage objects in complex documents with more control in InDesign CS5.

[Linking text stories \(PDF, 217 KB\)](#)

article (Jan. 1, 2011)

A short tutorial on the Place and Link Story feature in InDesign CS5.5.

[Live captions \(video 3:04\)](#)

Michael Ninness (Jan. 1, 2011)

video-tutorial

See how InDesign CS5 and later allow you to take advantage of metadata embedded in an image to create live captions and then automatically and flexibly place them in your layout.

[Making shiny graphics \(PDF, 203 KB\)](#)

Mike Rankin (Jan. 1, 2011)

article

This tutorial shows you how to apply a shiny, glossy effect on objects in your layout.

[Managing documents with multiple page sizes \(PDF, 136 KB\)](#)

article (Jan. 1, 2011)

A short tutorial on how to manage documents with multiple page sizes, in InDesign CS5 and later.

[Mini Bridge: Getting access to your assets \(PDF, 180 KB\)](#)

article (Jan. 1, 2011)

Use Bridge as a floating panel inside InDesign. yes Mini Bridge.

[Mixing page sizes with the new Page tool \(video 8:03\)](#)

Anne-Marie Concepcion (Jan. 1, 2011)

video-tutorial

Create complete brochures and book covers along with text with the new ability to mix page sizes within a single file

[New export options for EPUB \(video 05:56\), CS5.5](#)

Colin Fleming (Jan. 1, 2011)

video-tutorial

See an overview of all the new Export Options for EPUB in InDesign CS5.5, including the ordering panel and cover improvements.

[Paragraphs that span and split columns \(video 2:01\)](#)

Michael Ninness (Jan. 1, 2011)

video-tutorial

See how to build complex layouts in less clicks with paragraphs that span or split columns in InDesign CS5 and later.

[Rotating Spread view \(video 3:31\), CS4-CS6](#)

David Blatner (Jan. 1, 2011)

video-tutorial

When one or more objects on a page is rotated, learn how to rotate the spread view to make easy edits. Discover a number of navigation tips to save time.

[Saving production time \(PDF, 148 KB\), CS5](#)

article (Jan. 1, 2011)

Some small features that save you tons of time in CS5.

[Selection tool, Gap tool & Live Corner effects \(video 5:13\)](#)

Michael Ninness (Jan. 1, 2011)

video-tutorial

Watch how you can make short work of everyday layout tasks using these intuitive productivity tools.

[Setting object export options \(PDF, 160 KB\), CS5.5 and later](#)

article (Jan. 1, 2011)

How to use the Object Export options to streamline your export workflow.

[Spanning and Splitting columns \(video 6:15\)](#)

Anne-Marie Concepcion (Jan. 1, 2011)

video-tutorial

Set up spanning heads over any number of columns or split a group of columns into additional columns to save vertical space.

[Styles mapped to tags in InDesign for improved EPUB export \(video 05:13\)](#)

Colin Fleming (Jan. 1, 2011)

video-tutorial

In InDesign CS5.5 and later, you can map paragraph and character styles directly to EPUB, HTML and PDF tags to ensure that styles you define in InDesign are exported appropriately. You can also add CSS class names and type in your own custom tags.

[Track text changes \(video 2:01\)](#)

Michael Ninness (Jan. 1, 2011)

video-tutorial

Learn how to collaborate with even greater efficiency using new Track Text Changes in InDesign CS5 and later.

[Using Object Export options to customize how objects and images export to EPUB \(video 05:18\)](#)

Colin Fleming (Jan. 1, 2011)

video-tutorial

Use Object Export Options to customize how objects and images are exported to EPUB to ensure best viewing results on any screen - no matter what size.

[Working with Smart Guides \(video 4:04\), CS4-CS6](#)

Michael Ninness (Jan. 1, 2011)

video-tutorial

Take advantage of Smart Guides when creating, moving, rotating, and aligning objects. Learn how to avoid clutter in your layout.

Create new documents

Creating new documents

Create a new document

New Document options

Document window overview

Create custom page sizes

Define document presets

Create a document using a preset

Page design begins with the basics: starting a new document, setting up pages, and positioning margins and columns or changing grid settings.

[To the top](#)

Create a new document

1. Choose File > New > Document.

The New Document dialog box combines the Document Setup and the Margins And Columns dialog boxes, so that you can set up the page size, margins, and page columns all in one place. You can change these settings at any time.

2. Specify document setup options. (See [New Document options](#).)

To specify the dimensions of the bleed and slug areas, click the Arrow button before the Bleed and Slug label. The bleed and slug areas extend out from the edges of the defined Page Size. To make the bleed or slug areas extend evenly on all sides, click the Make All Settings The Same icon .

3. (Only in InDesign CC) Select the Preview checkbox to see how your new document will look like. Make necessary changes if required.

4. Click OK to open the new document with the settings you specified.

 To set default layout settings for all new documents, choose File > Document Setup or Layout > Margins And Columns, and set options when no documents are open.

[To the top](#)

New Document options

Document Preset Choose a preset that you have saved earlier.

Intent If you are creating a document to be output to PDF or SWF for the web, choosing the Web option changes several options in the dialog box, such as turning off Facing Pages, changing the orientation from portrait to landscape, and using a page size based on monitor resolution. You can edit any of these settings after the document is created.

CS6 and later: Digital publishing intent has been added for publications aimed for the Digital Publishing Suite. You can also change the intent of the document after it is created.

Number of pages Specify the number of pages to create in the new document.

Start Page # Specify which number the document starts on. If you specify an even number (such as 2) with Facing Pages selected, the first spread in the document begins with a two-page spread. See [Start a document with a two-page spread](#).



Facing Pages Select this option to make left and right pages face each other in a double-page *spread*, such as for books and magazines. Deselect this option to let each page stand alone, such as when you're printing flyers or posters or when you want objects to *bleed* in the binding. After you've created a document, you can use the Pages panel to create spreads with more than two pages or force the first two pages to open as a spread. (See [Control spread pagination.](#))

Master Text Frame *CS5.5 and earlier.* Select this option to create a text frame the size of the area within the margin guides, matching the column settings you specified. The master text frame is added to the A Master. (See [Using text frames on master pages.](#))

The Master Text Frame option is available only when you've chosen File > New > Document.

Primary Text Frame *CS6 and later.* select this option to add a primary text frame on the master page. When you apply a new master page, the story in the primary text frame automatically flows into the primary text frame of the new master page.

Page Size Choose a page size from the menu, or type values for Width and Height. Page size represents the final size you want after bleeds or other marks outside the page are trimmed.

Orientation Click Portrait  (tall) or Landscape  (wide). These icons interact dynamically with the dimensions you enter in Page Size. When Height is the larger value, the portrait icon is selected. When Width is the larger value, the landscape icon is selected. Clicking the deselected icon switches the Height and Width values.

Tip: To specify the dimensions of the bleed and slug areas, click the Arrow button before the Bleed and Slug label in the New Document dialog box. To make the bleed or slug areas extend evenly on all sides, click the Make All Settings The Same icon .

Bleed The Bleed area allows you to print objects that are arranged at the outer edge of the defined page size. For a page of the required dimensions, if an object is positioned at its edge, some white may appear at the edge of the printed area due to slight misalignment during printing or trimming. For this reason, you should position an object that is at the edge of the page of the required dimensions a little beyond the edge, and trim after printing. Bleed area is shown by a red line on the document. You can set bleed area settings from Bleed in the Print dialog box.

Slug The slug area is discarded when the document is trimmed to its final page size. The slug area holds printing information, customized color bar information, or displays other instructions and descriptions for other information in the document. Objects (including text frames) positioned in the slug area are printed but will disappear when the document is trimmed to its final page size.

Objects outside the bleed or slug area (whichever extends farther) do not print.

Preview (*Only in InDesign CC*) Select this checkbox to see how your new document will look like. Make necessary changes to the options if the preview is not as desired.

Note: You can also click the Save Document Preset icon to save document settings for future use.

[To the top](#)

Document window overview

Each page or spread in your document has its own pasteboard and guides, which are visible in Normal View mode. (To switch to Normal View, choose View > Screen Mode > Normal.) The pasteboard is replaced with a gray background when the document is viewed using one of the Preview modes. (See [Preview documents.](#)) You can change the color of this preview background and guides in Guides & Pasteboard preferences.

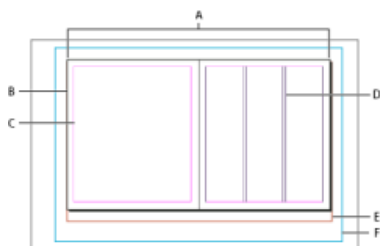

Document and guides in Normal View Mode

A. Spread (black lines) **B.** Page (black lines) **C.** Margin guides (magenta lines) **D.** Column guides (violet lines) **E.** Bleed area (red lines) **F.** Slug area (blue lines)

Document window notes:

- Lines of other colors are ruler guides which, when present, appear in the layer color when selected. See [Layers](#).
- Column guides appear in front of margin guides. When a column guide is exactly in front of a margin guide, it hides the margin guide.

[To the top](#)

Create custom page sizes

You can create custom page sizes that appear in the Page Size menu in the New Document dialog box.

1. Choose File > New > Document.
2. Choose Custom Page Size from the Page Size menu.
3. Type a name for the page size, specify page size settings, and then click Add.

The New Doc Sizes.txt file that lets you create custom page sizes in previous version of InDesign is not available in InDesign CS5 or later.

[To the top](#)

Define document presets

You can save document settings for page size, columns, margins, and bleed and slug areas in a preset to save time and ensure consistency when creating similar documents.

1. Choose File > Document Presets > Define.
2. Click New in the dialog box that appears.
3. Specify a name for the preset and select basic layout options in the New Document Preset dialog box. (See [New Document options](#) for a description of each option.)
4. Click OK twice.

 You can save a document preset to a separate file and distribute it to other users. To save and load document preset files, use the Save and Load buttons in the Document Presets dialog box.

[To the top](#)

Create a document using a preset

1. Do one of the following:
 - Choose File > Document Preset > *[name of preset]*. (Hold down Shift while choosing the preset to create a new document based on the preset without opening the New Document dialog box.)
 - Choose File > New > Document, and then choose a preset from the Document Preset menu in the New Document dialog box.

The New Document dialog box displays the preset layout options.

2. Make changes to the options (if desired) and click OK.

 *To skip the New Document dialog box, press the Shift key as you select a preset from the Document Preset menu.*

- [Recommended workflow for InDesign documents](#)
- [Use document templates](#)
- [Add documents to a book file](#)
- [Change document setup, margins, and columns](#)

 Twitter™ and Facebook posts are not covered under the terms of Creative Commons.

[Legal Notices](#) | [Online Privacy Policy](#)

Create new documents (Chinese, Japanese, and Korean only)

Creating new documents

[Create a new document](#)

[Create a new document with a layout grid](#)

[Create a new document with margins and columns](#)

[New Document options](#)

[Document window overview](#)

[Create custom page sizes](#)

[Define document presets](#)

[Create a document using a preset](#)

Page design begins with the basics: starting a new document, setting up pages, and positioning margins and columns or changing grid settings.

When creating a document you can select from two workflows, either Layout Grid or Margins and Columns.

note: *Whichever workflow you select, the file type of the document will be exactly the same. You can view a layout grid created in the document using Margins and Columns, or hide a document layout grid created using the Layout Grid option by switching between views.*

The workflow based on typesetting composition using Layout Grid is only available in Asian language versions. When you select Layout Grid, a grid of squares will be displayed in the document. You can set the number of individual squares (number of rows or characters) from the page size settings. Page margins will also be determined by this. By using a layout grid you can position an object accurately on a page using grid cell units.

The Margins and Columns workflow option is the same as in Western workflows. Western workflows are configured from Margins and Columns, and objects are arranged on pages without layout grids. You can set the writing direction to horizontal or vertical using either the Margins and Columns or Layout Grid workflow.



A document showing a layout grid (left) A document showing margins and columns (right)

[To the top](#)

Create a new document

1. Choose File > New > Document.

The New Document dialog box combines the Document Setup and the Margins And Columns dialog boxes, so that you can set up the page size, margins, and page columns all in one place. You can change these settings at any time.

2. Specify document setup options. (See New Document options.)

To specify the dimensions of the bleed and slug areas, click More Options. The bleed and slug areas extend out from the edges of the defined Page Size. To make the bleed or slug areas extend evenly on all sides, click the Make All Settings The Same icon .

3. Click OK to open a new document with the settings you specified.

Note: *To set default layout settings for all new documents, choose File > Document Setup or Layout > Margins And Columns, and set options when no documents are open.*

Create a new document with a layout grid

1. Choose File > New > Document.
2. Change the number of pages, page size, and other options. To specify the dimensions of the bleed and slug areas, click More Options.
3. Click Layout Grid Dialog, and then specify the layout grid settings. (See [Layout Grid options.](#))
4. Click OK to open a new document with the settings you specified.

The layout grid is for layout purposes only. To add text to your document, add frame grids or text frames.

Create a new document with margins and columns

When creating a document with Western style workflow, use Margins and Columns. If the general layout settings such as margins and number of columns in a document are already known, use the Margins and Columns dialog box as the simplest method.

1. Choose File > New > Document.
2. Specify options using the New Document dialog box. Each option is the same as when creating a document using a layout grid.
3. Click Margins and Columns and select your options using the New Margins and Columns dialog box. The options are the same as in the Margins and Columns dialog box. (See [Change document setup, margins, and columns.](#))
4. Click OK.

Even when a document has been created using Margins and Columns, you can view its layout grid by choosing View > Grids & Guides > Show Layout Grid, and you can modify the layout grid settings by choosing Layout > Layout Grid.

 *To set the default settings for all new documents, choose File > Document Setup, Layout > Margins and Columns, or Layout > Layout Grid Settings, and set options when no documents are open.*

New Document options

Document Preset Choose a preset that you have saved earlier.

Intent If you are creating a document to be output to PDF or SWF for the web, choosing the Web option changes several options in the dialog box, such as turning off Facing Pages, changing the orientation from portrait to landscape, and using a page size based on monitor resolution. You can edit any of these settings, but you cannot change the Intent setting after the document is created.

CS6: Digital publishing intent has been added for publications aimed for the Digital Publishing Suite.

Number of pages Specify the number of pages to create in the new document.

Start Page # Specify which number the document starts on. If you specify an even number (such as 2) with Facing Pages selected, the first spread in the document begins with a two-page spread. See [Start a document with a two-page spread](#).



Facing Pages Select this option to make left and right pages face each other in a double-page *spread*, such as for books and magazines. Deselect this option to let each page stand alone, such as when you're printing flyers or posters or when you want objects to *bleed* in the binding. After you've created a document, you can use the Pages panel to create spreads with more than two pages or force the first two pages to open as a spread. (See [Control spread pagination](#).)

Master Text Frame *CS5.5 and earlier*: Select this option to create a text frame the size of the area within the margin guides, matching the column settings you specified. The master text frame is added to the A-Master. (See [Using text frames on master pages](#).)

The Master Text Frame option is available only when you've chosen File > New > Document.

Primary Text Frame *CS6 only*: select this option to add a primary text frame on the master page. When you apply a new master page, the story in the primary text frame automatically flows into the primary text frame of the new master page.

Page Size Choose a page size from the menu, or type values for Width and Height. Page size represents the final size you want after bleeds or other marks outside the page are trimmed.

Orientation Click Portrait  (tall) or Landscape  (wide). These icons interact dynamically with the dimensions you enter in Page Size. When Height is the larger value, the portrait icon is selected. When Width is the larger value, the landscape icon is selected. Clicking the deselected icon switches the Height and Width values.

Tip: To specify the dimensions of the bleed and slug areas, click *More Options* in the New Document dialog box. To make the bleed or slug areas extend evenly on all sides, click the *Make All Settings The Same* icon .

Bleed The Bleed area allows you to print objects that are arranged at the outer edge of the defined page size. For a page of the required dimensions, if an object is positioned at its edge, some white may appear at the edge of the printed area due to slight misalignment during printing or trimming. For this reason, you should position an object that is at the edge of the page of the required dimensions a little beyond the edge, and trim after printing. Bleed area is shown by a red line on the document. You can set bleed area settings from Bleed in the Print dialog box.

Slug The slug area is discarded when the document is trimmed to its final page size. The slug area holds printing information, customized color bar information, or displays other instructions and descriptions for other information in the document. Objects (including text frames) positioned in the slug area are printed but will disappear when the document is trimmed to its final page size.

Objects outside the bleed or slug area (whichever extends farther) do not print.

Note: You can also click the *Save Document Preset* icon to save document settings for future use.

[To the top](#)

Document window overview

Each page or spread in your document has its own pasteboard and guides, which are visible in Normal View mode. (To switch to Normal View, choose View > Screen Mode > Normal.) The pasteboard is replaced with a gray background when the document is viewed using one of the Preview modes. (See [Preview documents](#).) You can change the color of this preview background and guides in Guides & Pasteboard preferences.

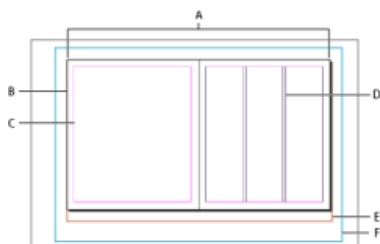

Document and guides in Normal View Mode

A. Spread (black lines) **B.** Page (black lines) **C.** Margin guides (magenta lines) **D.** Column guides (violet lines) **E.** Bleed area (red lines) **F.** Slug area (blue lines)

Document window notes:

- Lines of other colors are ruler guides which, when present, appear in the layer color when selected. See [Layers](#).
- Column guides appear in front of margin guides. When a column guide is exactly in front of a margin guide, it hides the margin guide.

[To the top](#)

Create custom page sizes

You can create custom page sizes that appear in the Page Size menu in the New Document dialog box.

1. Choose File > New > Document.
2. Choose Custom Page Size from the Page Size menu.
3. Type a name for the page size, specify page size settings, and then click Add.

The New Doc Sizes.txt file that lets you create custom page sizes in previous version of InDesign is not available in InDesign CS5 or later.

[To the top](#)

Define document presets

You can save document settings for page size, columns, margins, and bleed and slug areas in a preset to save time and ensure consistency when creating similar documents.

1. Choose File > Document Presets > Define.
2. Click New in the dialog box that appears.
3. Specify a name for the preset and select basic layout options in the New Document Preset dialog box. (See New Document options for a description of each option.)
4. Click OK twice.

 You can save a document preset to a separate file and distribute it to other users. To save and load document preset files, use the Save and Load buttons in the Document Presets dialog box.

[To the top](#)

Create a document using a preset

1. Do one of the following:
 - Choose File > Document Preset > *[name of preset]*. (Hold down Shift while choosing the preset to create a new document based on the preset without opening the New Document dialog box.)
 - Choose File > New > Document, and then choose a preset from the Document Preset menu in the New Document dialog box.

The New Document dialog box displays the preset layout options.

2. Make changes to the options (if desired) and click OK.

 *To skip the New Document dialog box, press the Shift key as you select a preset from the Document Preset menu.*

- [Recommended workflow for InDesign documents](#)
- [Use document templates](#)
- [Add documents to a book file](#)
- [Change document setup, margins, and columns](#)

 Twitter™ and Facebook posts are not covered under the terms of Creative Commons.

[Legal Notices](#) | [Online Privacy Policy](#)

Workspace and workflow

[Creating and saving your own workspace](#)

Jeff Witchel (Oct. 15, 2012)

video-tutorial

Learn how to personalize the workspace

[Working with Tools](#)

Kelly McCathran (May. 15, 2012)

video-tutorial

The InDesign toolbar contains a lot of tools, many of which are hidden or "nested" underneath the tools you see initially. In this video you will see the primary tools used to select, rotate and size objects. You'll also learn how to use the Type tool to edit text and create frames with or without borders, switch tools using your keyboard, and navigate with the Hand and Zoom tools.

Create new documents

Creating new documents

Create a new document

New Document options

Document window overview

Create custom page sizes

Define document presets

Create a document using a preset

Page design begins with the basics: starting a new document, setting up pages, and positioning margins and columns or changing grid settings.

[To the top](#)

Create a new document

1. Choose File > New > Document.

The New Document dialog box combines the Document Setup and the Margins And Columns dialog boxes, so that you can set up the page size, margins, and page columns all in one place. You can change these settings at any time.

2. Specify document setup options. (See [New Document options](#).)

To specify the dimensions of the bleed and slug areas, click the Arrow button before the Bleed and Slug label. The bleed and slug areas extend out from the edges of the defined Page Size. To make the bleed or slug areas extend evenly on all sides, click the Make All Settings The Same icon .

3. (Only in InDesign CC) Select the Preview checkbox to see how your new document will look like. Make necessary changes if required.

4. Click OK to open the new document with the settings you specified.

 *To set default layout settings for all new documents, choose File > Document Setup or Layout > Margins And Columns, and set options when no documents are open.*

[To the top](#)

New Document options

Document Preset Choose a preset that you have saved earlier.

Intent If you are creating a document to be output to PDF or SWF for the web, choosing the Web option changes several options in the dialog box, such as turning off Facing Pages, changing the orientation from portrait to landscape, and using a page size based on monitor resolution. You can edit any of these settings after the document is created.

CS6 and later: Digital publishing intent has been added for publications aimed for the Digital Publishing Suite. You can also change the intent of the document after it is created.

Number of pages Specify the number of pages to create in the new document.

Start Page # Specify which number the document starts on. If you specify an even number (such as 2) with Facing Pages selected, the first spread in the document begins with a two-page spread. See [Start a document with a two-page spread](#).



Facing Pages Select this option to make left and right pages face each other in a double-page *spread*, such as for books and magazines. Deselect this option to let each page stand alone, such as when you're printing flyers or posters or when you want objects to *bleed* in the binding. After you've created a document, you can use the Pages panel to create spreads with more than two pages or force the first two pages to open as a spread. (See [Control spread pagination.](#))

Master Text Frame *CS5.5 and earlier.* Select this option to create a text frame the size of the area within the margin guides, matching the column settings you specified. The master text frame is added to the A Master. (See [Using text frames on master pages.](#))

The Master Text Frame option is available only when you've chosen File > New > Document.

Primary Text Frame *CS6 and later.* select this option to add a primary text frame on the master page. When you apply a new master page, the story in the primary text frame automatically flows into the primary text frame of the new master page.

Page Size Choose a page size from the menu, or type values for Width and Height. Page size represents the final size you want after bleeds or other marks outside the page are trimmed.

Orientation Click Portrait  (tall) or Landscape  (wide). These icons interact dynamically with the dimensions you enter in Page Size. When Height is the larger value, the portrait icon is selected. When Width is the larger value, the landscape icon is selected. Clicking the deselected icon switches the Height and Width values.

Tip: To specify the dimensions of the bleed and slug areas, click the Arrow button before the Bleed and Slug label in the New Document dialog box. To make the bleed or slug areas extend evenly on all sides, click the Make All Settings The Same icon .

Bleed The Bleed area allows you to print objects that are arranged at the outer edge of the defined page size. For a page of the required dimensions, if an object is positioned at its edge, some white may appear at the edge of the printed area due to slight misalignment during printing or trimming. For this reason, you should position an object that is at the edge of the page of the required dimensions a little beyond the edge, and trim after printing. Bleed area is shown by a red line on the document. You can set bleed area settings from Bleed in the Print dialog box.

Slug The slug area is discarded when the document is trimmed to its final page size. The slug area holds printing information, customized color bar information, or displays other instructions and descriptions for other information in the document. Objects (including text frames) positioned in the slug area are printed but will disappear when the document is trimmed to its final page size.

Objects outside the bleed or slug area (whichever extends farther) do not print.

Preview (*Only in InDesign CC*) Select this checkbox to see how your new document will look like. Make necessary changes to the options if the preview is not as desired.

Note: You can also click the Save Document Preset icon to save document settings for future use.

[To the top](#)

Document window overview

Each page or spread in your document has its own pasteboard and guides, which are visible in Normal View mode. (To switch to Normal View, choose View > Screen Mode > Normal.) The pasteboard is replaced with a gray background when the document is viewed using one of the Preview modes. (See [Preview documents.](#)) You can change the color of this preview background and guides in Guides & Pasteboard preferences.

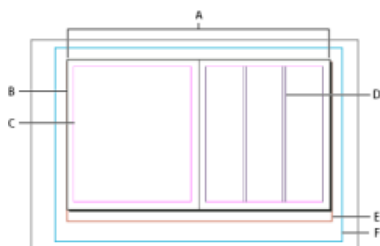

Document and guides in Normal View Mode

A. Spread (black lines) **B.** Page (black lines) **C.** Margin guides (magenta lines) **D.** Column guides (violet lines) **E.** Bleed area (red lines) **F.** Slug area (blue lines)

Document window notes:

- Lines of other colors are ruler guides which, when present, appear in the layer color when selected. See [Layers](#).
- Column guides appear in front of margin guides. When a column guide is exactly in front of a margin guide, it hides the margin guide.

[To the top](#)

Create custom page sizes

You can create custom page sizes that appear in the Page Size menu in the New Document dialog box.

1. Choose File > New > Document.
2. Choose Custom Page Size from the Page Size menu.
3. Type a name for the page size, specify page size settings, and then click Add.

The New Doc Sizes.txt file that lets you create custom page sizes in previous version of InDesign is not available in InDesign CS5 or later.

[To the top](#)

Define document presets

You can save document settings for page size, columns, margins, and bleed and slug areas in a preset to save time and ensure consistency when creating similar documents.

1. Choose File > Document Presets > Define.
2. Click New in the dialog box that appears.
3. Specify a name for the preset and select basic layout options in the New Document Preset dialog box. (See [New Document options](#) for a description of each option.)
4. Click OK twice.

 You can save a document preset to a separate file and distribute it to other users. To save and load document preset files, use the Save and Load buttons in the Document Presets dialog box.

[To the top](#)

Create a document using a preset

1. Do one of the following:
 - Choose File > Document Preset > *[name of preset]*. (Hold down Shift while choosing the preset to create a new document based on the preset without opening the New Document dialog box.)
 - Choose File > New > Document, and then choose a preset from the Document Preset menu in the New Document dialog box.

The New Document dialog box displays the preset layout options.

2. Make changes to the options (if desired) and click OK.

 *To skip the New Document dialog box, press the Shift key as you select a preset from the Document Preset menu.*

- [Recommended workflow for InDesign documents](#)
- [Use document templates](#)
- [Add documents to a book file](#)
- [Change document setup, margins, and columns](#)

 Twitter™ and Facebook posts are not covered under the terms of Creative Commons.

[Legal Notices](#) | [Online Privacy Policy](#)

Sync Settings using Adobe Creative Cloud | CC

What's covered?

[Introduction](#)

[Sync settings at first launch](#)

[Using the sync settings feature](#)

[Sync settings on successive launches](#)

[Managing sync](#)

[What's not supported](#)

[To the top](#)

Introduction

When you work on multiple computers, managing and syncing glyph sets, menu customizations, keyboard shortcuts, custom workspaces, and PDF presets among the computers could be a chore.

The new Sync Settings feature enables individual users to sync their settings using Creative Cloud. If you use two computers, for example, one at home and another at work, the Sync Settings feature makes it easy for you to keep those settings synchronized on these two computers. Also, if you have replaced your old computer with a new one and have reinstalled InDesign, you can get the application set up quickly with all your settings in place by just pressing a button.

Note: *At any given time, you can activate InDesign on two computers only.*

The syncing happens via your Adobe Creative Cloud account. All the settings are uploaded to Creative Cloud and then are downloaded and applied on the other computer.

All sync operations are initiated by users. They cannot be scheduled or performed automatically (such as at launch or during shutdown).

Prerequisites for this feature to work:

- Computers should be connected to the Internet.
- You have signed into your Adobe Creative Cloud account on both computers.

[To the top](#)

Sync settings at first launch

After installation, when you launch the application and create a document or open an existing document for the first time, you will see a prompt asking whether you want to start the sync.



- Click **Sync Settings Now** to initiate the sync.
- Click **Disable Sync Settings** to disable the feature.
- Click **Advanced** to open the Preferences dialog, where you can choose and customize what items are synchronize.

[To the top](#)

Using the sync settings feature

Do any one of the following:

- [Recommended] Click the Sync Settings icon (🔄) at the lower-left corner of the InDesign active document window, and then click **Sync Settings Now**.
- Click **Edit (Mac: InDesign) > {AdobeID logged in} > Sync Settings Now**.

[To the top](#)

Sync settings on successive launches

When you launch InDesign with prior sync information available, and create a document or open an existing document for the first time, you will see a prompt asking whether you would like to sync the setting from the cloud. To initiate the sync, click **Sync Settings Now**.



The settings are downloaded to your local computers and are updated in the application. If you change glyph sets, keyboard shortcuts, custom workspaces, or PDF presets, you should initiate sync before you close the application. You can see the sync status in the left-bottom corner of the document status bar. Click the Sync Settings icon (🔄) in the status bar and then click **Sync Settings Now**.

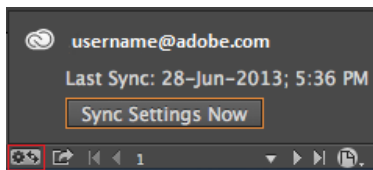

[To the top](#)

Managing sync

What gets synced

- Workspaces
- Menu sets
- PDF presets
- Keyboard shortcuts
- Glyphs sets

Choose what you want to sync

Navigate to the Preferences > Sync Settings tab:

- Click **Edit (Mac: InDesign) > {AdobeID logged in} > Manage Sync Settings**.
or
- Click **Edit (Mac: InDesign) > Preferences > Sync Settings**.

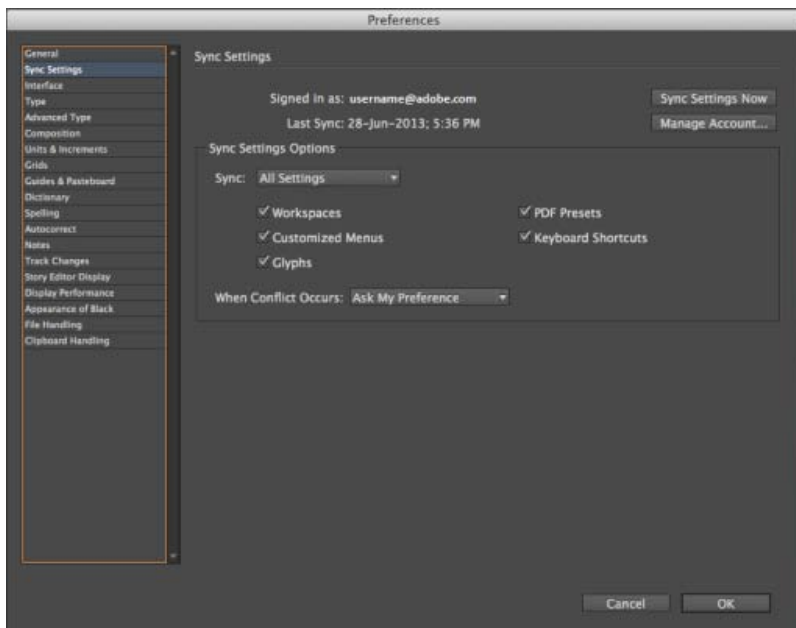

Select the checkboxes for the settings that you want to sync. You can also choose what to do in case of conflict.

Note: To sync your settings successfully, you must change the settings only from within the application. The sync settings feature does not sync any file that is manually placed in a folder location.

Choose an option in case of conflict

There are situations when the system could detect sync conflicts. Sync conflicts occur when the system is unable to determine whether you want a setting from Creative Cloud or from your local computer to be retained since both have been changed after the last sync operation.

Suppose that you change PDF presets on your work computer and sync settings to the Cloud. You then go home and change the same presets on your home computer without syncing with the cloud first. Now since the settings in the cloud and the settings on your home computer are both updated, conflict occurs when you try to sync. If you try to sync in this state, you see a conflict prompt.

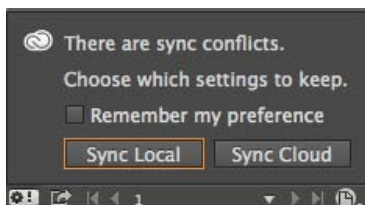

- Sync Local: Sync local settings on this computer to the cloud; overwrite the cloud version with the local version of settings.
- Sync Cloud: Sync from the cloud to this local computer; ignore changes made to the local settings and replace them with the settings in the cloud.

[To the top](#)

What's not supported

- Keyboard shortcuts created for Windows will only sync with a Windows computer. Mac keyboard shortcuts will only sync with a Mac computer.
- Assets saved to a custom location are not synced.
- Any modifications (for example: rearrangement of panel) made after creation of the Workspace will not be synced. For Workspace syncing,

first set up your working environment and then create a workspace and initiate the sync process.

 Twitter™ and Facebook posts are not covered under the terms of Creative Commons.

[Legal Notices](#) | [Online Privacy Policy](#)

Working with files and templates

[Recommended workflow for InDesign documents](#)

[Open InDesign documents](#)

[Convert earlier versions of InDesign documents](#)

[Using Adobe Bridge with InDesign](#)

[Adobe Version Cue](#)

[Use document templates](#)

[Reviewing InDesign documents](#)

[Designing calendars and business cards from templates](#)

[To the top](#)

Recommended workflow for InDesign documents

You can improve performance and prevent many problems by establishing a good workflow to use with Adobe InDesign.

Maintain a clean computer system

Over time, changes occur to software and hardware that can lead to performance loss and system problems. Defragmenting the hard disk, removing older versions of software, updating device drivers, optimizing memory, running virus protection utilities, and performing other maintenance tasks can prevent applications and files from becoming damaged. Performing these tasks regularly helps ensure that InDesign opens, displays, and prints documents as expected.

Create a project folder

Before you begin a project, determine which files you'll need and how you'll store them. If you've experienced problems with broken links, consider storing your linked files in the same folder as your document. InDesign maintains links to files you place in a document, but if a link is broken, InDesign looks for the file in the document's folder. Storing a document and its linked files in the same folder makes it easy to move them from one computer to another. Storing files in one folder also ensures that InDesign finds the original graphics when printing a document. If InDesign cannot locate a linked graphic, it won't reflect changes you make to the original graphic, and it may print the graphic poorly or not at all.

If your project consists of multiple documents (for example, chapters in a book), you may find it useful to create a project folder that contains a folder for each document and its linked files.

Consider using a template

Use a template if you frequently create similar projects. Templates let you create consistent documents more quickly while protecting the original file. For example, if you create a monthly newsletter, your template might include ruler guides, page numbers, the newsletter masthead, and styles you want to use in each issue. (See [Use document templates](#).)

Open documents locally

Before you open a document stored on a network volume or on removable media, copy the document and any linked graphics to your local hard disk. The slower access time and data transfer rate of a network volume or removable media can cause data to become lost or corrupted, possibly damaging the document. However, be aware of overriding someone else's work if you copy the local files back to a network server.

Solve problems before converting a file

Damaged Adobe PageMaker or QuarkXPress® files usually remain damaged when opened in InDesign. If an error or other unexpected behavior occurs with a converted file, open the original file in the source application and troubleshoot it for damage.

If the converted file has problems, export it to IDML format, and then open the IDML file and save it as an InDesign document.

Save documents

Save documents frequently, and create backup copies of important files. You can clear unnecessary data from a document by using the Save As command. When you use the Save command, InDesign appends new information to the document but doesn't remove outdated data, such as information about a deleted graphic. When you use the Save As command, however, InDesign completely rewrites the document, including only information about objects and pages currently in the document. A document that contains only necessary data occupies less hard drive space and redraws and prints more quickly.

Practice good design habits

- Create styles in a document. Creating styles with no documents open can cause duplicate styles to appear when you create a new document. To share styles in documents, save the styles and load them.
- Use appropriate fonts. When choosing fonts for a document, consider how you intend to format and print the text. InDesign works well with OpenType®, Type 1 (also called PostScript), and TrueType fonts. Damaged or poorly constructed fonts can damage an InDesign document or cause it to print with unexpected results, so use reliable fonts created by established font vendors. If you work with a service bureau, find out its font requirements.
- Avoid using too many text frames. Use as few text frames as possible to keep the document file size smaller and the layout easier to manipulate.

Be smart with art

- Use the appropriate graphics file format. When you create graphics for a project, consider how you plan to print the document. If you intend to print the document at a service bureau, ask the service bureau which graphic formats work best with the output device it uses. The service bureau can also advise you on the optimal resolution for images.
- Store graphics externally. When you import a graphic file, InDesign creates a link to the graphic by default. Linking helps minimize the file size of the document and improves the performance of InDesign. When you print the document, the original graphic file must be available and linked. If InDesign can't find the original, the graphic may print as a low resolution preview or as a gray box.

Verify links and fonts before you print

To ensure that a document prints correctly, verify that all links are intact and all fonts are available. A link becomes broken if you delete, move, or rename the original graphic. Use the Preflight and Package features before handing off files to a service bureau.

[To the top](#)

Open InDesign documents

In general, you open document and template files the same way you do in other programs. When you open an InDesign template, it opens as a new, untitled document by default. Document files use the extension .indd, template files use the extension .indt, snippet files use the extension .idms, library files use the extension .indl, interchange files use the extension .inx, markup files use the extension .idml, and book files use the extension .indb.

You can also use the File > Open command to open files from earlier versions of InDesign, InDesign Interchange (.inx) files, InDesign Markup (.idml) files, Adobe PageMaker 6.0 and later, QuarkXPress 3.3 and 4.1, and QuarkXPress Passport 4.1 files. In addition, other software vendors may make plug-in software that lets you open other file formats.

 *To view additional information about an InDesign document, hold down Ctrl and choose Help > About InDesign (Windows) or hold down Command and choose InDesign > About InDesign (Mac OS).*

Use the Open command

1. Choose File > Open and select one or more documents.

2. Do one of the following, and then click Open:

- Select Normal (Windows) or Open Normal (Mac OS) to open the original document or a copy of a template.
- Select Original (Windows) or Open Original (Mac OS) to open an original document or template.
- Select Copy (Windows) or Open Copy (Mac OS) to open a copy of a document or template.

3. If a warning message appears telling you that the color settings in the document are different from the color settings in the application, select an option, and click OK.

Note: Color warning messages are off by default, but you can show warnings if you change the default settings in the Color Settings dialog box (Edit > Color Settings.)

4. If a warning message appears telling you that the document contains missing fonts, do one of the following:

- Click OK. InDesign will automatically format the text with a substitute.
- Click Find Font to search for and list fonts used throughout your document.
For more information on finding missing fonts, see Find and change fonts.

5. If a warning message appears telling you that the document contains missing or modified links, use the Links panel to fix the links. See Update, restore, and replace links.

Open recent document

- Choose File > Open Recent, and select one of the documents you saved recently.

To specify how many recent documents are displayed, choose Edit > Preferences > File Handling (Windows), or InDesign > Preferences > File Handling, and then specify a number for Number Of Recent Items To Display. The maximum number is 30.

Choosing word lists when opening documents

When opening a document, you may see an alert message asking if you want to use the word list in the document or an exception word list in the user dictionary. An *exception* word list includes words that were added to the User Dictionary while the document was worked on. If you know which exception word list you use, click its button. If you're not sure, click either button, choose Edit > Spelling > Dictionary to inspect the word lists, and then, if necessary, choose Edit > Preferences > Dictionary (Windows) or InDesign > Preferences > Dictionary (Mac OS) to reset the word list used for composition. See Hyphenation and spelling dictionaries.

[To the top](#)

Convert earlier versions of InDesign documents

- To convert previous versions of InDesign documents to the current version, choose File > Open and open the file.

Keep in mind the following points:

- If you used third-party plug-ins to create an earlier version of a document, check with the manufacturer to make sure that they are installed correctly for and are compatible with InDesign CS5 before you convert the document.

- When you convert a document, you may see an alert message asking if you want to use the exception word list in the user dictionary or the one in the document. For information about this alert message, see [Choosing word lists when opening documents](#).
- Library files created in earlier versions of InDesign will open and convert in InDesign CS5, even if the library is locked. You have to specify a name and location for the converted library files; the default naming convention is *filename-X.indl*.
- Previous versions of InDesign can't open latest InDesign documents directly. For example, to open an InDesign CS5 document in InDesign CS4, you must do two things. First, choose File > Export in InDesign CS5 to save the document in IDML format. Second, update InDesign CS4 with special plug-ins that let you open the IDML file. (See Save backwards to the previous InDesign version.)

 *If you're experiencing problems with a document that was created in a previous version of InDesign, use the Export dialog box in InDesign CS5 to save the document in InDesign Markup (IDML) format. Then open the IDML file and save it as an InDesign document.*

[To the top](#)

Using Adobe Bridge with InDesign

Adobe Bridge is a cross-platform application included with Adobe Creative Suite components that helps you locate, organize, and browse the assets you need to create print, web, video, and audio content. You can start Adobe Bridge from any Creative Suite component (except Adobe Acrobat®), and use it to access both Adobe and non-Adobe asset types.

From Adobe Bridge, you can:

- Manage image, footage, and audio files: Preview, search, sort, and process files in Adobe Bridge without opening individual applications. You can also edit metadata for files, and use Adobe Bridge to place files into your documents, projects, or compositions.
- View the links inside an InDesign document as thumbnails while in Adobe Bridge, without actually having to open the InDesign document in InDesign.
- Drag assets from Adobe Bridge into the InDesign document window, or drag assets from the document window into Adobe Bridge to create snippets. See Use snippets.
- Perform automated tasks, such as batch commands.
- Synchronize color settings across color-managed Creative Suite components.
- Start a real-time web conference to share your desktop and review documents.

[To the top](#)

Adobe Version Cue

Adobe Version Cue® and Adobe Drive are not included in Adobe Creative Suite 5, nor any future version of the Creative Suite. Adobe continues to invest in asset management enablement through open industry standards and partnerships. For more information, see www.adobe.com/go/learn_vc_end_en.

[To the top](#)

Use document templates

Templates are useful starting points for standard documents because you can preset them with layout, graphics, and text. For example, if you prepare a monthly magazine, you can create a template that contains the layout of a typical issue, including ruler guides, grids, master pages, custom styles and swatches, placeholder frames, layers, and any standard graphics or text. That way you can simply open the template each month and import new content.

You create a template the same way you create a regular document; the only difference occurs when you save the document. When you prepare a template for others to use, you may want to add a layer containing instructions about the template; hide or delete the layer before printing the document. See Layers.

Note: *For Chinese versions of InDesign, you can open specially designed templates that include custom mojikumi sets.*

Save a document as a template

1. Choose File > Save As, and specify a location and filename.

2. Choose InDesign CS5 Template for Save As Type (Windows) or Format (Mac OS), and then click Save.

Start a new document from a template

1. Choose File > Open.
2. Locate and select a template.
3. Select Normal (Windows) or Open Normal (Mac OS), and then click Open.
4. Save the new document with its own name.

Edit an existing template

1. Choose File > Open.
2. Locate and select a template.
3. Select Original (Windows) or Open Original (Mac OS), and then click Open.

[To the top](#)

Reviewing InDesign documents

Adobe offers several methods for reviewing InDesign documents.

Tracking editing changes

As you or another person edits text, InDesign highlights added text and strikes through deleted text when Track Changes is turned on. Use the Story Editor to view changes. The document owner can go through the edits and accept or reject changes. See [Tracking and reviewing changes](#).

Using Acrobat to review a PDF file

You can export the InDesign document to PDF and use Adobe Acrobat to set up an e-mail review or a shared review on Acrobat.com or another server. Reviewers can add comments using the Sticky Note tool and other markup methods. The document owner can then go through the PDF review comments and edit the original InDesign document. For more information, see [Acrobat Help](#).

Using CS Review

CS Review is an online subscription service that lets you share your designs on the web so that others can provide immediate feedback. When you create a review using the CS Review panel, you upload one or more snapshots of the file to the Acrobat.com workspace. Reviewers can then add comments.

When you create a review, you can divide the review into *parts* that offer separate areas for review commenting. A review can consist of parts from different files and applications. As the review progresses, you can add and remove review parts as part of a dynamic review process.

[To the top](#)

Designing calendars and business cards from templates

One way to create a calendars, business cards, resumes or CVs, and other specialized documents is to use templates.

Adobe provides several templates at the Adobe Marketplace and Exchange site:

www.adobe.com/go/exchange

Use search to locate additional resources for specialty documents.

Adobe also recommends

- Adobe Bridge
- Mini Bridge
- CS Review



Twitter™ and Facebook posts are not covered under the terms of Creative Commons.

[Legal Notices](#) | [Online Privacy Policy](#)

Customize menus and keyboard shortcuts

- [Customize menus](#)
- [Missing menu commands](#)
- [Use keyboard shortcut sets](#)

[To the top](#)

Customize menus

Hiding and colorizing menu commands is a way to remove menu clutter and emphasize commands you frequently use. Note that hiding menu commands simply removes the menu command from view; it doesn't disable any features. At any time, you can view hidden commands by selecting the Show All Menu Items command at the bottom of a menu, or you can choose Window > Workspace > Show Full Menus to show all the menus for the selected workspace. You can include customized menus in workspaces you save.

You can customize the main menu, context menus, and panel menus. Context menus appear when you right-click (Windows) or Control-click (Mac OS) an area. Panel menus appear when you click the icon in the upper right of a panel.

Note: If you select a different workspace, such as Getting Started, some menu commands are hidden. To display menu commands, choose Show All Menu Items at the bottom of the menu, or choose a different workspace, such as Advanced.

Create a custom menu set

1. Choose Edit > Menus.

You cannot edit the default menu set.

2. Click Save As, type the name of the menu set, and click OK.
3. From the Category menu, choose Application Menus or Context & Panel Menus to determine which menus are customized.
4. Click the arrows to the left of the menu categories to display subcategories or menu commands. For each command you want to customize, click the eye icon under Visibility to show or hide the command; click None under Color to select a color from the menu.
5. Click Save, and then click OK.

Select a custom menu set

1. Choose Edit > Menus.
2. Choose the menu set from the Set menu, and then click OK.

Edit or delete a custom menu set

1. Choose Edit > Menus.
2. Choose the menu set from the Set menu, and then do one of the following:

- To edit a menu set, change the visibility or color of menu commands, click Save, and then click OK.
- To delete a menu set, click Delete and then click Yes. If you've modified the menu set without saving it, you're prompted to save the current menu set. Click Yes to save the menu set, or click No to discard changes.

Show hidden menu items

- Choose Window > Workspace > Show Full Menus. This command turns on all menus for the selected workspace. You can hide the menus again by resetting the workspace.
- Choose Show All Menu Items at the bottom of the menu that includes hidden commands.

 Holding down *Ctrl* (Windows) or *Command* (Mac OS) and clicking a menu name temporarily displays any menu commands you've hidden by customizing menus.

[To the top](#)

Missing menu commands

If you can't find a menu command, it may be hidden. If you select a workspace other than Advanced, some menu commands are hidden. It's also possible that you or someone else used the Menus command to hide menu items.

If you can't find a command you're looking for, try any of these techniques:

- Choose Show All Menu Items at the bottom of the menu.
- Choose Window > Workspace > Show Full Menus.
- Choose Window > Workspace, and select a different workspace (Advanced shows all menu items).
- Choose Edit > Menus, locate the menu command, and make sure it isn't hidden.

If menu commands are still missing, try restoring preferences.

[To the top](#)

Use keyboard shortcut sets

Tool tips provide an instantaneous reference for shortcuts. InDesign also provides a shortcut editor in which you can view and generate a list of all shortcuts, and edit or create your own shortcuts. The shortcut editor includes all the commands that accept shortcuts, but some of these commands are undefined in the Default shortcut set.

You can also associate keyboard shortcuts with paragraph or character styles (see Add paragraph and character styles) or scripts.

Mike Witherell provides a reference guide of keyboard shortcuts on [Free keyboard shortcuts](#) (English only).

Change the active shortcut set

1. If you want the shortcut set to be active for all documents, make sure that no documents are open.
2. Choose Edit > Keyboard Shortcuts.
3. Select a shortcut set in the Set menu. For example, select Shortcuts for QuarkXPress® 4.0.
4. Click OK.

View shortcuts

1. Choose Edit > Keyboard Shortcuts.
2. For Set, select a shortcut set.
3. For Product Area, select the area containing the commands you want to view.
4. From Commands, select a command. The shortcut is displayed in the Current Shortcut section.

Generate a list of shortcuts for printing

1. Choose Edit > Keyboard Shortcuts.
2. For Set, select a shortcut set.
3. Click Show Set.

A text file opens with all current and undefined shortcuts for that set.

Create a new shortcut set

1. Choose Edit > Keyboard Shortcuts.
2. Click New Set.
3. Type a name for the new set, select a shortcut set in the Based On Set menu, and click OK.

Create or redefine a shortcut

1. Choose Edit > Keyboard Shortcuts.
2. For Set, select a shortcut set or click New Set to create a new shortcut set.

Note: You cannot edit the Default or the QuarkXPress shortcut sets. Instead, create a new set based on one of these sets, and then edit the new set.

3. For Product Area, select the area containing the command you want to define or redefine.
4. In the Commands list, select the command that you want to define or redefine.
5. In the New Shortcut box, press the keys for your new keyboard shortcut. If the key sequence is currently being used for another command, InDesign displays that command under Current Shortcuts. You can choose to change the original shortcut also, or try another shortcut.

Note: Do not assign single-key shortcuts to menu commands, because they interfere with the typing of text. If an insertion point is active when you type a single-key shortcut, InDesign activates the keyboard shortcut instead of inserting the character in the text.

6. In the Context list, select the context in which you want the keyboard shortcut to function. The context ensures that the shortcut performs the

way you intended. For example, you can assign Ctrl+G to merge table cells (Table context) and Ctrl+G to insert special characters (Text context).

Note: Assign shortcuts in the Default context when you want them to function regardless of the current state of the document. Shortcuts you assign in other contexts, such as Table or Text, override shortcuts assigned in the Default context.

7. Do one of the following:

- Click Assign to create a new shortcut where none currently exists.
- Click Assign to add another shortcut to a command. Menu commands can have multiple keyboard shortcuts.

8. Click OK to close the dialog box, or click Save to keep the dialog box open while you enter more shortcuts.

Copying keyboard shortcut sets

Keyboard shortcut sets (*.indk) are saved in two locations. The application preset shortcuts appear in the Presets folder in the main application folder. The shortcut sets you create appear in the Shortcut Sets folder in the following locations:

Windows XP Documents and Settings\[username]\Application Data\Adobe\InDesign\[version]\[language]\InDesign Shortcut Sets

Windows Vista and Windows 7 Users\[username]\AppData\Roaming\Adobe\InDesign\[Version]\[Language]\InDesign Shortcut Sets

Mac OS Users/[username]/Library/Preferences/Adobe InDesign/[version]/[language]/InDesign Shortcut Sets

If you created a keyboard shortcut set on one computer and want to use it on a different computer, copy the *.indk file to the same location on the other computer.

You can move a keyboard set from the custom location to the application folder. Doing so makes the custom shortcuts available to all the users sharing a computer. However, make sure that you do not have two sets with the same name, one in each place. Make sure that the application keyboard sets and the custom sets have different names.

Adobe also recommends

 Twitter™ and Facebook posts are not covered under the terms of Creative Commons.

[Legal Notices](#) | [Online Privacy Policy](#)

Workspace basics

- [Workspace overview](#)
- [Manage windows and panels](#)
- [Save and switch workspaces](#)
- [About view modes](#)
- [Using the status bar](#)
- [Control panel overview](#)
- [About the Navigator panel](#)
- [Use context menus](#)
- [Change Interface preferences](#)

Click the following links for more information.

[To the top](#)

Workspace overview

You create and manipulate your documents and files using various elements, such as panels, bars, and windows. Any arrangement of these elements is called a *workspace*. The workspaces of the different applications in Adobe® Creative Suite® 5 share the same appearance so that you can move between the applications easily. You can also adapt each application to the way you work by selecting from several preset workspaces or by creating one of your own.

Although the default workspace layout varies in different products, you manipulate the elements much the same way in all of them.

- The *Application bar* across the top contains a workspace switcher, menus (Windows only), and other application controls. On the Mac for certain products, you can show or hide it using the Window menu.
- The *Tools panel* contains tools for creating and editing images, artwork, page elements, and so on. Related tools are grouped.
- The *Control panel* displays options for the currently selected tool. In Illustrator, the Control panel displays options for the currently selected object. (In Adobe Photoshop® this is known as the Options bar. In Adobe Flash®, Adobe Dreamweaver®, and Adobe Fireworks® this is known as the Property Inspector and includes properties of the currently selected element.)
- The *Document window* displays the file you're working on. Document windows can be tabbed and, in certain cases, grouped and docked.
- *Panels* help you monitor and modify your work. Examples include the Timeline in Flash, the Brush panel in Illustrator, the Layers panel in Adobe Photoshop®, and the CSS Styles panel in Dreamweaver. Panels can be grouped, stacked, or docked.
- The *Application frame* groups all the workspace elements in a single, integrated window that lets you treat the application as a single unit. When you move or resize the Application frame or any of its elements, all the elements within it respond to each other so none overlap. Panels don't disappear when you switch applications or when you accidentally click out of the application. If you work with two or more applications, you can position each application side by side on the screen or on multiple monitors.

If you are using a Mac and prefer the traditional, free-form user interface, you can turn off the Application frame. In Adobe Illustrator®, for example, select Window > Application Frame to toggle it on or off. (In Flash, the Application frame is on permanently for Mac, and Dreamweaver for Mac does not use an Application frame.)

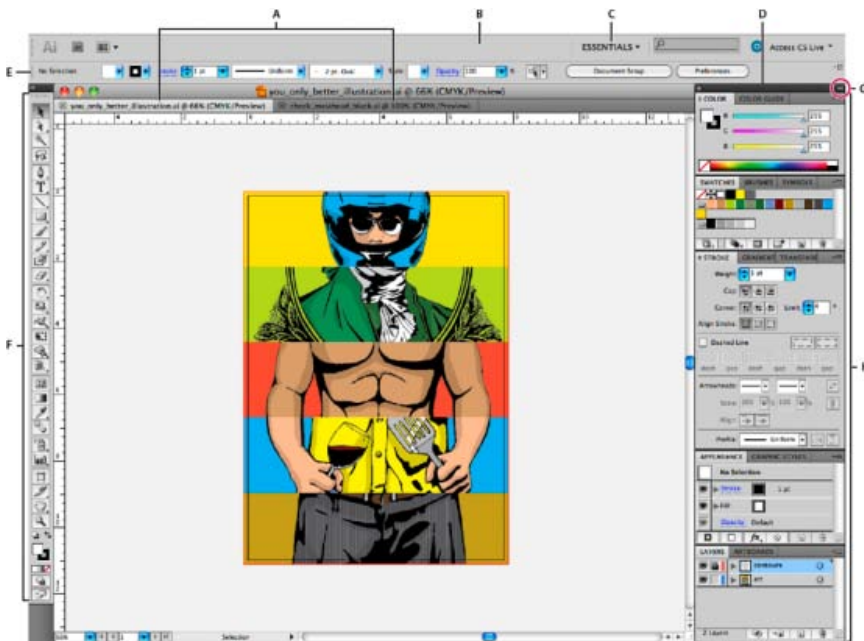

Default Illustrator workspace

A. Tabbed Document windows **B.** Application bar **C.** Workspace switcher **D.** Panel title bar **E.** Control panel **F.** Tools panel **G.** Collapse To Icons button **H.** Four panel groups in vertical dock

Hide or show all panels

- (Illustrator, Adobe InCopy®, Adobe InDesign®, Photoshop, Fireworks) To hide or show all panels, including the Tools panel and Control panel, press Tab.
- (Illustrator, InCopy, InDesign, Photoshop) To hide or show all panels except the Tools panel and Control panel, press Shift+Tab.

💡 You can temporarily display hidden panels if Auto-Show Hidden Panels is selected in Interface preferences. It's always on in Illustrator. Move the pointer to the edge of the application window (Windows®) or to the edge of the monitor (Mac OS®) and hover over the strip that appears.

- (Flash, Dreamweaver, Fireworks) To hide or show all panels, press F4.

Display panel options

- Click the panel menu icon  in the upper-right corner of the panel.

💡 You can open a panel menu even when the panel is minimized.

💡 In Photoshop, you can change the font size of the text in panels and tool tips. In the Interface preferences, choose a size from the UI Font Size menu.

(Illustrator) Adjust panel brightness

- In User Interface preferences, move the Brightness slider. This control affects all panels, including the Control panel.

Reconfigure the Tools panel

You can display the tools in the Tools panel in a single column, or side by side in two columns. (This feature is not available in the Tools panel in

Fireworks and Flash.)

 In *InDesign* and *InCopy*, you also can switch from single-column to double-column (or single-row) display by setting an option in Interface preferences.

- Click the double arrow at the top of the Tools panel.

[To the top](#)

Manage windows and panels

You can create a custom workspace by moving and manipulating Document windows and panels. You can also save workspaces and switch among them. For Fireworks, renaming custom workspaces can lead to unexpected behavior.

Note: The following examples use *Photoshop* for demonstration purposes. The workspace behaves the same in all the products.

Rearrange, dock, or float document windows

When you open more than one file, the Document windows are tabbed.

- To rearrange the order of tabbed Document windows, drag a window's tab to a new location in the group.
- To undock (float or untab) a Document window from a group of windows, drag the window's tab out of the group.

Note: In *Photoshop* you can also choose *Window > Arrange > Float in Window* to float a single Document window, or *Window > Arrange > Float All In Windows* to float all of the Document windows at once. See tech note [kb405298](#) for more information.

Note: *Dreamweaver* does not support docking and undocking Document windows. Use the Document window's Minimize button to create floating windows (Windows), or choose *Window > Tile Vertically* to create side-by-side Document windows. Search "Tile Vertically" in *Dreamweaver Help* for more information on this topic. The workflow is slightly different for Macintosh users.

- To dock a Document window to a separate group of Document windows, drag the window into the group.
- To create groups of stacked or tiled documents, drag the window to one of the drop zones along the top, bottom, or sides of another window. You can also select a layout for the group by using the Layout button on the Application bar.

Note: Some products do not support this functionality. However, your product may have Cascade and Tile commands in the Window menu to help you lay out your documents.

- To switch to another document in a tabbed group when dragging a selection, drag the selection over the document's tab for a moment.

Note: Some products do not support this functionality.

Dock and undock panels

A dock is a collection of panels or panel groups displayed together, generally in a vertical orientation. You dock and undock panels by moving them into and out of a dock.

- To dock a panel, drag it by its tab into the dock, at the top, bottom, or in between other panels.
- To dock a panel group, drag it by its title bar (the solid empty bar above the tabs) into the dock.
- To remove a panel or panel group, drag it out of the dock by its tab or title bar. You can drag it into another dock or make it free-floating.

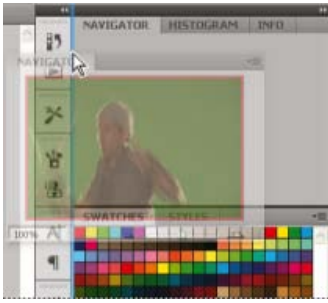

Navigator panel being dragged out to new dock, indicated by blue vertical highlight



Navigator panel now in its own dock

 You can prevent panels from filling all the space in a dock. Drag the bottom edge of the dock up so it no longer meets the edge of the workspace.

Move panels

As you move panels, you see blue highlighted *drop zones*, areas where you can move the panel. For example, you can move a panel up or down in a dock by dragging it to the narrow blue drop zone above or below another panel. If you drag to an area that is not a drop zone, the panel floats freely in the workspace.

Note: The position of the mouse (rather than the position of the panel), activates the drop zone, so if you can't see the drop zone, try dragging the mouse to the place where the drop zone should be.

- To move a panel, drag it by its tab.
- To move a panel group, drag the title bar.

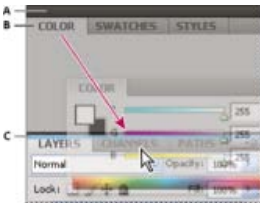

Narrow blue drop zone indicates Color panel will be docked on its own above the Layers panel group.

A. Title bar **B.** Tab **C.** Drop zone

 Press **Ctrl** (Windows) or **Command** (Mac OS) while moving a panel to prevent it from docking. Press **Esc** while moving the panel to cancel the operation.

Add and remove panels

If you remove all panels from a dock, the dock disappears. You can create a dock by moving panels to the right edge of the workspace until a drop

zone appears.

- To remove a panel, right-click (Windows) or Control-click (Mac) its tab and then select Close, or deselect it from the Window menu.
- To add a panel, select it from the Window menu and dock it wherever you want.

Manipulate panel groups

- To move a panel into a group, drag the panel's tab to the highlighted drop zone in the group.

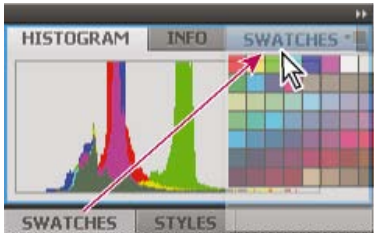

Adding a panel to a panel group

- To rearrange panels in a group, drag a panel's tab to a new location in the group.
- To remove a panel from a group so that it floats freely, drag the panel by its tab outside the group.
- To move a group, drag the title bar (the area above the tabs).

Stack floating panels

When you drag a panel out of its dock but not into a drop zone, the panel floats freely. The floating panel allows you to position it anywhere in the workspace. You can stack floating panels or panel groups so that they move as a unit when you drag the topmost title bar.

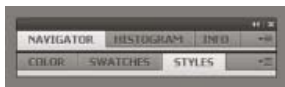

Free-floating stacked panels

- To stack floating panels, drag a panel by its tab to the drop zone at the bottom of another panel.
- To change the stacking order, drag a panel up or down by its tab.

Note: Be sure to release the tab over the narrow drop zone between panels, rather than the broad drop zone in a title bar.

- To remove a panel or panel group from the stack, so that it floats by itself, drag it out by its tab or title bar.

Resize panels

- To minimize or maximize a panel, panel group, or stack of panels, double-click a tab. You can also double-click the tab area (the empty space next to the tabs).
- To resize a panel, drag any side of the panel. Some panels, such as the Color panel in Photoshop, cannot be resized by dragging.

Collapse and expand panel icons

You can collapse panels to icons to reduce clutter on the workspace. In some cases, panels are collapsed to icons in the default workspace.



Panels collapsed to icons

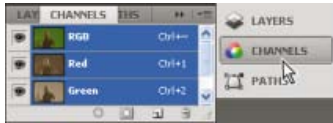

Panels expanded from icons

- To collapse or expand all panel icons in a column, click the double arrow at the top of the dock.
- To expand a single panel icon, click it.
- To resize panel icons so that you see only the icons (and not the labels), adjust the width of the dock until the text disappears. To display the icon text again, make the dock wider.
- To collapse an expanded panel back to its icon, click its tab, its icon, or the double arrow in the panel's title bar.

 *In some products, if you select Auto-Collapse Icon Panels from the Interface or User Interface Options preferences, an expanded panel icon collapses automatically when you click away from it.*

- To add a floating panel or panel group to an icon dock, drag it in by its tab or title bar. (Panels are automatically collapsed to icons when added to an icon dock.)
- To move a panel icon (or panel icon group), drag the icon. You can drag panel icons up and down in the dock, into other docks (where they appear in the panel style of that dock), or outside the dock (where they appear as floating icons).

[To the top](#)

Save and switch workspaces

By saving the current size and position of panels as a named workspace, you can restore that workspace even if you move or close a panel. The names of saved workspaces appear in the workspace switcher in the Application bar.

Save a custom workspace

1. With the workspace in the configuration you want to save, do one of the following:
 - (Illustrator) Choose Window > Workspace > Save Workspace.
 - (Photoshop, InDesign, InCopy) Choose Window > Workspace > New Workspace.
 - (Dreamweaver) Choose Window > Workspace Layout > New Workspace.
 - (Flash) Choose New Workspace from the workspace switcher in the Application bar.
 - (Fireworks) Choose Save Current from the workspace switcher in the Application bar.

2. Type a name for the workspace.
3. (Photoshop, InDesign) Under Capture, select one or more options:

Panel Locations Saves the current panel locations (InDesign only).

Keyboard shortcuts Saves the current set of keyboard shortcuts (Photoshop only).

Menus or Menu Customization Saves the current set of menus.

Display or switch workspaces

- Select a workspace from the workspace switcher in the Application bar.

 *In Photoshop, you can assign keyboard shortcuts to each workspace to navigate among them quickly.*

Delete a custom workspace

- Select Manage Workspaces from the workspace switcher in the Application bar, select the workspace, and then click Delete. (The option is not available in Fireworks.)
- (Photoshop, InDesign, InCopy) Select Delete Workspace from the workspace switcher.
- (Illustrator) Choose Window > Workspace > Manage Workspaces, select the workspace, and then click the Delete icon.
- (Photoshop, InDesign) Choose Window > Workspace > Delete Workspace, select the workspace, and then click Delete.

Restore the default workspace

1. Select the Default or Essentials workspace from the workspace switcher in the application bar. For Fireworks, see the article http://www.adobe.com/devnet/fireworks/articles/workspace_manager_panel.html.

Note: *In Dreamweaver, Designer is the default workspace.*

2. For Fireworks (Windows), delete these folders:

Windows Vista

\\Users\

Windows XP

\\Documents and Settings\

3. (Photoshop, InDesign, InCopy) Select Window > Workspace > Reset [*Workspace Name*].

(Photoshop) Restore a saved workspace arrangement

In Photoshop, workspaces automatically appear as you last arranged them, but you can restore the original, saved arrangement of panels.

- To restore an individual workspace, choose Window > Workspace > Reset *Workspace Name*.
- To restore all the workspaces installed with Photoshop, click Restore Default Workspaces in the Interface preferences.

 *To rearrange the order of workspaces in the application bar, drag them.*

[To the top](#)

About view modes

You can change the visibility of the document window using the Mode buttons at the bottom of the toolbox or by choosing commands from the View > Screen Mode menu. When the toolbox is displayed in a single column, you can select view modes by clicking the current mode button and selecting a different mode from the menu that appears.

Normal Mode

Displays artwork in a standard window with all visible grids and guides showing, non-printing objects showing, and a white pasteboard.

Preview Mode

Displays artwork as if it were output, with all non-printing elements suppressed (grids, guides, non-printing objects), and the pasteboard set to the preview background color defined in Preferences.

Bleed Mode

Displays artwork as if it were output, with all non-printing elements suppressed (grids, guides, non-printing objects), the pasteboard set to the preview background color defined in Preferences, and any printing elements within the document's bleed area (defined in Document Setup) showing.

Slug Mode

Displays artwork as if it were output, with all non-printing elements suppressed (grids, guides, non-printing objects), the pasteboard set to the preview background color defined in Preferences, and any printing elements within the document's slug area (defined in Document Setup) showing.

Presentation Mode

Displays artwork as if it were a slideshow presentation, with no menus, panels, or tools displayed. See Use Presentation Mode.

[To the top](#)

Using the status bar

The status bar (at the lower left of a document window) shows information about the status of a file and lets you turn to a different page. Click the status bar menu to do any of the following:

- Show the current file in the file system by choosing Reveal In Explorer (Windows®) or Reveal In Finder (Mac OS®).
- Show the current file in Adobe® Bridge® by choosing Reveal in Bridge.
- Show the current file in Adobe Mini Bridge by choosing Reveal in Mini Bridge.

 *In Mac OS, you can display the zoom percentage in the status bar by hiding the application bar (Window > Application Bar). In Windows, you cannot hide the application bar.*

[To the top](#)

Control panel overview

The Control panel (Window > Control) offers quick access to options, commands, and other panels related to the current page item or objects you select. By default, the Control panel is docked to the top of the document window; however, you can dock it to the bottom of the window, convert it to a floating panel, or hide it altogether.

Options displayed in the Control panel vary depending on the type of object you select:

- When you select a frame, the Control panel displays options for resizing, repositioning, skewing, and rotating the frame, or applying an object style.
- When you select text inside a frame, the Control panel displays either character or paragraph options. Click the paragraph and character icons on the left side of the Control panel to determine whether paragraph or character options are displayed. If your monitor size and resolution allows, the Control panel displays additional options. For example, if the character icon is selected, all the character options are displayed, and some paragraph options appear on the right of the Control panel. If you click the paragraph icon, all paragraph options are displayed, and some character options appear on the right.
- When you select a table cell, the Control panel displays options for adjusting row and column dimensions, merging cells, aligning text, and adding strokes.

As the options in the Control panel change, you can get more information about each option by using *tool tips*—pop-up descriptions that appear when you hover over an icon or option label with the pointer.



Control panel with tool tip displayed

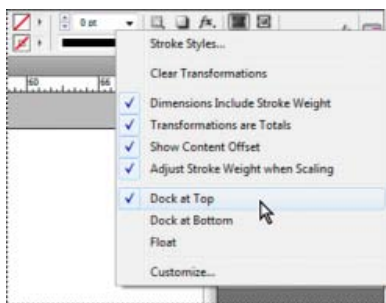

Control panel menu

To open dialog boxes associated with Control panel icons, Alt-click (Windows) or Option-click (Mac OS) as you click a Control panel icon. For example, when a frame is selected, hold down Alt or Option and click the Rotation Angle icon  to open the Rotate dialog box.

Display the panel menu

- Click the icon  to the right of the Control panel.

Dock or float the Control panel

- Do one of the following:
 - Drag the vertical bar on the left side of the Control panel until the toolbar is docked to the top or bottom of the application window (Windows) or screen (Mac OS).
 - Choose Dock At Top, Dock At Bottom, or Float from the Control panel menu.

Customize the Control panel

1. Choose Customize from the Control panel menu located on the right side of the Control panel.

2. Specify options that you want to display or hide, and then click OK.

[To the top](#)

About the Navigator panel

If you're familiar with previous versions of InDesign, you may wonder why you can't find the Navigator panel. The Navigator panel does not appear in InDesign CS5. The Power Zoom feature effectively replaces the Navigator panel. See [Use power zoom](#).

[To the top](#)

Use context menus

Unlike the menus that appear at the top of your screen, context-sensitive menus display commands related to the active tool or selection. You can use context menus as a quick way to choose commonly used commands.

1. Position the pointer over the document, object, or panel.
2. Click the right mouse button.

Note: (Mac OS) If you don't have a two-button mouse, you can display a context menu by pressing the Control key as you click with the mouse.

[To the top](#)

Change Interface preferences

1. Choose Edit > Preferences > Interface (Windows) or InDesign > Preferences > Interface (Mac OS).
2. Choose the settings you want to specify, and click OK.

Tool Tips Tool tips appear when you hold the mouse pointer over interface items such as tools in the toolbar and options in the Control panel. Choose None to turn off tool tips.

Show Thumbnails On Place When you place a graphic, a thumbnail of the image appears in the loaded graphics cursor. Similarly, a thumbnail of the first few lines of text appears in the loaded text cursor. Deselect this option if you don't want thumbnails to appear when placing graphics or text.

Show Transformation Values When you're creating, sizing, or rotating an object, the cursor displays the [x,y] coordinates, width and height, or rotation information.

Enable Multi-Touch Gestures Select this option to allow Windows and Mac OS multi-touch mouse gestures to work in InDesign. For example, when you use the Magic Mouse in Mac OS, the swipe gesture scrolls up or down or moves to the previous or next page or spread, and the rotate gesture rotates the spread.

Highlight Object Under Selection Tool Select this option to highlight the frame edges of objects when the direct selection tool is moved over it.

Floating Tools Panel Specify whether the toolbar appears as a single column, double column, or single row.

Auto-Collapse Icon Panels When this option is selected, clicking the document window closes the open panel automatically.

Auto-Show Hidden Panels When you hide panels by pressing Tab, holding the mouse pointer over the side of the document window temporarily reveals the panels if this option is selected. If this option is not selected, you must press Tab again to display panels.

Open Documents As Tabs When this option is deselected, documents you create or open appear as floating windows rather than tabbed windows.

Enable Floating Document Window Docking If this option is selected, you can dock floating documents with each other as tabbed windows. If this option is deselected, floating document windows aren't docked with other document windows, unless you hold down Ctrl (Windows) or Command (Mac OS) while dragging.

Hand Tool To control whether to skew text and images when you scroll a document, drag the Hand Tool slider to the desired level of performance versus quality.

Live Screen Drawing Select an option to determine whether the image redraws as you drag an object. If Immediate is selected, the image redraws while you drag. If Never is selected, dragging an image moves only the frame, and then image is moved when you release the mouse button. If Delayed is selected, the image redraws only if you pause before dragging. Delayed offers the same behavior as in InDesign CS4.

Adobe also recommends

- [Control Panel video](#)

 Twitter™ and Facebook posts are not covered under the terms of Creative Commons.

[Legal Notices](#) | [Online Privacy Policy](#)

Recovery and undo

Recover documents Undo mistakes

[To the top](#)

Recover documents

InDesign guards your data against unexpected power or system failures using an automatic recovery feature. Automatically recovered data exists in a temporary file that is separate from the original document file on disk. Under normal circumstances you don't need to think about automatically recovered data, because any document updates stored in the automatic recovery file are automatically added to the original document file when you choose the Save or Save As command or exit from InDesign normally. Automatically recovered data is important only if you're unable to save successfully before an unexpected power or system failure.

Even though these features exist, you should save your files often and create backup files in case of unexpected power or system failures.

Find recovered documents

1. Restart your computer.
2. Start InDesign.

If automatically recovered data exists, InDesign automatically displays the recovered document. The word [Recovered] appears after the filename in the title bar of the document window to indicate that the document contains unsaved changes that were automatically recovered.

Note: *If InDesign fails after attempting to open a document using automatically recovered changes, the automatically recovered data may be corrupted.*

3. Do one of the following:
 - To save the recovered data, choose File > Save As, specify a location and a new filename, and click Save. The Save As command keeps the recovered version that includes the automatically recovered data; the word [Recovered] disappears from the title bar.
 - To discard automatically recovered changes and use the most recent version of the document that was explicitly saved to disk before the failure occurred, close the file without saving it and open the file on disk, or choose File > Revert.

Change the location of recovered documents

1. Choose Edit > Preferences > File Handling (Windows) or InDesign > Preferences > File Handling (Mac OS).
2. Under Document Recovery Data, click Browse (Windows) or Choose (Mac OS).
3. Specify the new location for the recovered document, click Select (Windows) or Choose (Mac OS), and then click OK.

[To the top](#)

Undo mistakes

If necessary, you can cancel a lengthy operation before it's completed, undo recent changes, or revert to a previously saved version. You can undo or redo up to several hundred of the most recent actions (the amount is limited by the amount of RAM available and the kinds of actions you performed). The series of actions is discarded when you choose the Save As command, close a document, or when you exit from the program.

- Do one of the following:
 - To undo the most recent change, choose Edit > Undo *[action]*. (You cannot undo certain actions, such as scrolling.)
 - To redo an action, choose Edit > Redo *[action]*.
 - To undo all changes made since the last time you saved the project, choose File > Revert (InDesign) or File > Revert Content (InCopy).
 - To close a dialog box without applying changes, click Cancel.

 Twitter™ and Facebook posts are not covered under the terms of Creative Commons.

[Legal Notices](#) | [Online Privacy Policy](#)

Working with managed files

- [Open shared content](#)
- [Check out content](#)
- [Opening managed files \(InCopy\)](#)
- [Update assignment files \(InDesign\)](#)
- [Update content](#)
- [Accidentally updating your work](#)
- [Update the InDesign layout](#)
- [Check in content](#)
- [Save changes \(InDesign\)](#)
- [Save changes \(InCopy\)](#)

[To the top](#)

Open shared content

Only InCopy users can open assignment files (.inca). If an InCopy user opens an InDesign file that contains assignments, the user will have access to all the managed content, regardless of assignments.

- Do one of the following.
 - In InCopy, choose File > Open, select an assignment file (.icma or .inca), and click Open.
 - In InDesign or InCopy, choose File > Open, select an InDesign file (.indd) that contains assigned content, and click Open.
 - Open an assignment package. See [Receive packages \(InCopy\)](#).

The assignment names and their contents appear in the Assignments panel.

[To the top](#)



Check out content

When you check out an item, a hidden lock file (.idlk) is placed on the file system. Once the content is checked out, you have exclusive control over its content, and others are locked out from making changes. You can check out InCopy content only; you cannot check out InDesign documents with layout information.

If you attempt to close an InDesign document containing one or more InCopy content files that are checked out to you, an alert message appears, prompting you to check in all content. If you close the document without checking in the content files, they will still be checked out to you the next time you open the InDesign document. Saving the InDesign document automatically saves every editable InCopy content file.

Check out content (InDesign)

- Do one of the following:
 - In the layout, select the text or graphics frames to edit and choose Edit > InCopy > Check Out.
 - In the Assignments panel, select the files and choose Check Out from the panel menu.

When you check out available content in InDesign, you see the Editing icon  on the InDesign frame. In InCopy, the In Use icon  appears on the InCopy frame and in the Assignments panel if the assignment files are stored on a local server.

Check out content (InCopy)

1. Do one of the following:



- If the content you want is part of an assignment, choose File > Open and select the assignment file (.icma or .inca).
- If the content you want was exported as individual files, choose File > Open and select the InCopy file (.icml or .incx). To see the layout so you can do copyfitting, select the InDesign document.

2. Do one of the following:

- To check out a single InCopy content file, choose File > Check Out.
- To check out all content in an assignment at once, select the assignment in the Assignments panel, and choose Check Out from the panel menu.
- To check out individual items in an assignment, open the assignments list in the Assignments panel, select an item or multiple items, and choose Check Out from the panel menu.

The Editing icon  appears next to the item or items in the Assignments panel, indicating that the content is checked out to you for your exclusive use.

3. If prompted to update the content with changes, click OK.

When you check out available content in InCopy, you see the Editing icon  on the InCopy frame, and in the Assignments panel. In InDesign, the In Use icon  appears on the InDesign frame.

[To the top](#)

Opening managed files (InCopy)

Opening a managed content file (.icml or .incx) directly in InCopy and working with it in Story view may be more appropriate for quick writing and editing. You do not have to check out an individual managed file to edit it; InCopy automatically checks it out. When you save and close the file, InCopy automatically checks in the content. The Save commands are different when you open individual files.

[To the top](#)

Update assignment files (InDesign)

You can save changes to assignments manually or when you close the current document. Updating an assignment file is the only way to make layout changes available to InCopy users.

• Do one of the following:

- To update selected assignments, select them in the Assignments panel and choose Update Selected Assignments from the Assignments panel menu.
- To update all out-of-date assignments in the current document, choose Update Out-Of-Date Assignments from the Assignments panel menu. Only assignments that are out of date are updated.
- To update all assignments in the current document, choose Update All Assignments from the Assignments panel menu.





Note: If an InCopy user has an assignment open when you update the assignment, the Out Of Date icon  appears next to the assignment in the InCopy Assignments panel.

Update content

To make sure that you're always working on the most up-to-date content, be sure to watch for Out Of Date icons in the Assignments panel, and then update content accordingly. Updating an InCopy assignment file and its contents or updating individual content files copies data from the latest file system copy so that the version displayed on your computer matches the one on the file system. Updating does not require checking in or out and does not give you editing rights. However, updating can cause problems if another user has deleted your lock.

Note: *Updating content does not update content in assignment packages that have not been returned.*

A typical updating workflow is as follows:

1. The InCopy user opens an assignment file or checks out an individual content file and edits the content.
2. The InCopy user saves the content file, which updates the copy on the file system, and continues working.
3. The InDesign user sees the Out Of Date icon  in both the Assignments panel and the Links panel next to the selection, and the In Use  and Text Content Out Of Date icon  or Graphics Content Out Of Date icon  on the associated frame.

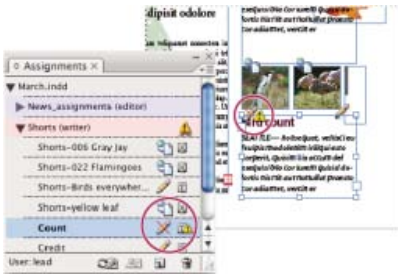

Assignments panel with In Use and Out Of Date icons (left) and Layout with out-of-date content (right)

4. The InDesign user updates the content.

Update content while opening a managed document (InDesign)

1. Choose File > Open, locate the file you want to open, and click Open.
2. Click Yes when prompted to update the document with the modified content on the file system.
3. Do one of the following:
 - To let InDesign update the links, click Fix Links Automatically.
 - To fix links manually, click Don't Fix, and then, in the Links panel, select the file to update and choose Update Link from the panel menu.

Update content while working (InDesign)

- Do one of the following:

- Select the text or graphics frames in the layout and choose Edit > InCopy > Update Content.
- Select the text or graphics frames in the Links panel, and click the Update Link button  or choose Update Link from the Assignments panel menu.

Update content while working (InCopy)

- Do one of the following:
 - Click an insertion point in the text frame to select it, and then choose File > Update Content.
 - Select the content in the Assignments panel, and then click the Update Content button  or choose Update Content from the Assignments panel menu.

You can also update content using the Links panel.

[To the top](#)

Accidentally updating your work

In most cases, the update commands are disabled for content you have checked out, because that content would always be up to date. However, an undesirable situation can occur if a different user deletes the lock on checked-out content (by dragging the lock file [.idlk] to the Recycle Bin [Windows] or Trash [Mac OS]), and modifies the content. In this case, the update commands can become enabled even while the content is checked out to you, essentially allowing two people to edit the content at the same time. Updating the content results in lost work. For best results, do not delete the lock files.

[To the top](#)



Update the InDesign layout

InDesign users can modify the layout (for example, change the size or location of the text frames of a story) and save the changes while InCopy users are modifying the text of these text frames. In a shared server workflow, the way InCopy users are notified about layout changes depends on whether they have opened an assignment file or have checked out individual content files and also opened the linked InDesign file.

Consider the following:

- If an InDesign user changes the layout of frames in an assignment, the user must update the assignment to make the design changes available to InCopy users. InDesign does not automatically update assignment files when the document is saved.
- Once the InDesign user updates the assignment stored on a shared server, the Out Of Date icon  appears next to the assignment in the InCopy Assignments panel. The InCopy user must update the design to see the current layout.
- If an InDesign user changes the layout of exported content that is not part of an assignment, the Out Of Date icon appears next to the InDesign document name in the Assignments panel, and the document title bar indicates the layout is out-of-date. InCopy users can update the currently active InDesign document with the latest layout and style changes.

Updating the layout in InCopy is useful for copyfitting tasks, because the latest appearance and line breaks are visible in Layout and Galley views.

- Do one of the following:
 - If you have an assignment file open and the Assignments panel shows the Out Of Date icon  next to the assignment name, click the Update Design button , or choose File > Update Design. You cannot undo this command.
 - If you are not working with assignment files and you have more than one InDesign document open, select the one you want to make active, and choose File > Update Design.

[To the top](#)

Check in content

When you check in a managed content file, you save it to a shared location on a file system where it can be checked out by others for editing or other changes. Exporting a text or graphics frame from InDesign also checks it in automatically.

Although a checked-in file is available for editing, it is not actually editable until it is checked out (unless you edit the content in stand-alone mode in InCopy). Checking in content relinquishes editing control, but does not close the file. The content remains open on your screen, but in a read-only state.

The LiveEdit Workflow plug-ins do not create multiple file versions. Instead, files are overwritten when updated in either InCopy or InDesign.

If you are working on an assignment package, return or forward the assignment package after checking it in.

Check in managed content (InDesign)

- Do one of the following:
 - Select the content in the layout and choose Edit > InCopy > Check In.
 - In the Assignments panel, select the content and choose Check In from the panel menu.

Check in managed content (InCopy)

- Do one of the following:
 - Select the content in Layout view and choose File > Check In.
 - In the Assignments panel, select the content and choose Check In from the panel menu.

Note: You can undo the most recent changes before you check in content.



When you check in a file, the Available icon appears on the text or graphics frame in the InDesign layout, in the InCopy Layout view, in the Assignments panel, and in the story bar (InCopy).

[To the top](#)

Save changes (InDesign)

As you work on content you have checked out, you can save your changes and update the file-system copy.

- Do one of the following:
 - To save the selected content without saving changes to the InDesign document or any of its linked files, select the content in the layout and choose Edit > InCopy > Save Content.
 - To save every content file checked out to you, choose File > Save. This type of save does not automatically update assignment files or checked-out content files in InCopy. However, the checked-out files in InCopy will show the Out Of Date icon 🚩 in the Assignments panel.
 - To save the InDesign document under a new name with links to any existing InCopy files, choose File > Save As. This action causes the assignments in the InDesign file to appear as missing until they are updated.
 - To save a copy of the currently active document, choose File > Save A Copy. You can choose to give the copy a new name and location with links to any existing InCopy files.

[To the top](#)

Save changes (InCopy)

- Do one of the following:

- To save the InCopy file under the same name and location on the file system, choose File > Save Content. The file is still checked out to you.
- To save the InCopy content file under a new name, choose File > Save Content As. The newly created content file is not managed in the workflow. The Save Content As command is available only if you have opened the InCopy content file (.icml or .incx) directly.
- To save a copy of the currently active InCopy content file, choose File > Save Content Copy. You can choose to give the copy a new name and location. The saved copy is not managed in the workflow. The Save Content Copy command is available only if you have opened the InCopy content file (.icml or .incx) directly.
- To save all currently open and checked-out InCopy content files, choose File > Save All Content. This saves all files to their current locations. The Save All Content command is available only if you have opened an assignment or InDesign file.

Adobe also recommends

- Work with stand-alone documents

 Twitter™ and Facebook posts are not covered under the terms of Creative Commons.

[Legal Notices](#) | [Online Privacy Policy](#)

Viewing the workspace

[Zoom in and out](#)

[Adjust the view](#)

[Turn pages](#)

[Work with additional windows](#)

[Use anti-aliasing for smoothing edges](#)

[Greek type](#)

[Calculate values in panels and dialog boxes](#)

[Enter values in panels and dialog boxes](#)

[To the top](#)

Zoom in and out

Use the Zoom tool or the Zoom commands to magnify the size of documents.

Zoom in or out

- To zoom in, select the Zoom tool  and click the area you want to magnify. Each click magnifies the view to the next preset percentage, centering the display around the point you click. At maximum magnification, the center of the Zoom tool appears blank. To zoom out, hold down Alt (Windows) or Option (Mac OS) and click the area you want to reduce. Each click reduces the view.
- To magnify to the next preset percentage, activate the window you want to view and choose View > Zoom In. To reduce the view to the previous preset percentage, choose View > Zoom Out.
- To set a specific magnification level, type or choose a level in the Zoom Level box in the application bar.

 *In Mac OS, you can display the zoom percentage in the status bar by hiding the application bar (Window > Application Bar). In Windows, you cannot hide the application bar.*

- To zoom in or out, press Alt (Windows) or Option (Mac OS) while using the mouse scroll wheel or sensor.
- To magnify by dragging, select the Zoom tool and drag around the area you want to magnify.

Use power zoom

Power zoom offers a quick way to scroll through your document pages. Using the grabber hand, you can use zoom in or out and scroll through your entire document. This feature is especially useful for long documents.

You must be in Layout view to use power zoom.

1. Click the Hand tool .

To activate the grabber hand, you can also hold down the spacebar or hold down Alt/Option while in text mode.

2. With the grabber hand active, click and hold down the mouse button.

The document zooms out so that you can see more of the spread. A red box indicates the view area.

3. With the mouse button still held down, drag the red box to scroll through the document pages. Press arrow keys or use the mouse scroll wheel to change the size of the red box.
4. Release the mouse button to zoom in on the new area of the document.

The document window returns to its original zoom percentage or to the size of the red box.

Zoom to Actual Size

- Double-click the Zoom tool.
- Choose View > Actual Size.
- Type or choose a magnification level of 100 in the Zoom Level box in the application bar.

[To the top](#)

Adjust the view

Focus on the desired area of your document by fitting pages and spreads within the active window and by scrolling the view.

Fit the page, spread, or pasteboard within the active window

- Choose View > Fit Page In Window.
- Choose View > Fit Spread In Window.
- Choose View > Entire Pasteboard.

Scroll the view

You can easily adjust the degree to which pages or objects are centered in the document window. These techniques are also useful for navigating between pages.



- Do any of the following:
 - Select the Hand tool  from the Tools panel, and then click and drag in the document window. Holding down Alt (Windows) or Option (Mac OS) and pressing the spacebar temporarily activates the Hand tool.
 - Click the horizontal or vertical scroll bars or drag the scroll box.
 - Press Page Up or Page Down.
 - Use the mouse scroll wheel or sensor to scroll up and down. To pan left or right, press Ctrl (Windows) or Command (Mac OS) as you use the mouse scroll wheel or sensor.



[To the top](#)



Turn pages

InDesign makes it easy to jump from page to page in a document. For example, just as most web browsers provide Back and Forward buttons to navigate through pages you've visited, InDesign keeps track of the order in which you've viewed pages in a document.

- Do any of the following:

- To move through pages in the order in which you viewed them during the current session, choose Layout > Go Back or Go Forward.
- To go to the next or previous page, click the Next Page button  or Previous Page button  at the bottom of the document window, or choose Layout > Next Page or Previous Page.

Note: Page navigation controls are sensitive to R or L binding. If the document is read from right to left, for example,  becomes the Next Page button and  becomes the Previous Page button.

- To go to the first or last page, click the First Spread button  or Last Spread button  at the lower left of the document window, or choose Layout > First Page or Last Page.
- To go to a specific page, choose Layout > Go To Page, specify the page number, and click OK. Or, click the downward-facing arrow at the right of the page box, and then choose a page.

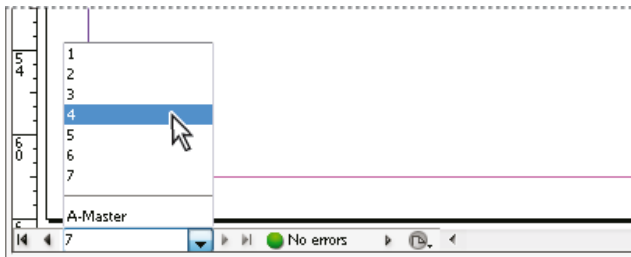

Choose page from page box to go to specific page

- To go to a master page, click in the page box at the lower left of the document window. Type the first few letters of the master page name, and press Enter (Windows) or Return (Mac OS). Or, in the Pages panel, double-click a master page icon.

[To the top](#)

Work with additional windows

You can open additional windows for the same document or for other InDesign documents. With additional windows, you can compare different spreads simultaneously, especially spreads that aren't adjacent. You can also display different magnifications of the same page, so that you can work closely on details while watching how the changes affect the overall layout. In addition, you can display a master page in one window, and pages based on it in other windows, to see how editing the master page affects various parts of the document.

When you reopen the document, only the last-used window appears.

- To create a new window for the same document, choose Window > Arrange > New Window.
- To cascade or tile windows, choose Window > Arrange > Cascade to arrange all windows into a stack, with each window offset slightly. Or, choose Window > Arrange > Tile to display all windows equally without overlapping.
- To activate a window, click the window tab or title bar. Or, choose the name of the view in the Window menu. Multiple windows for a document are numbered in the order they were created.
- To close all windows for the active document, press Shift+Ctrl+W (Windows) or Shift+Command+W (Mac OS).
- To close all windows for all open documents, press Shift+Ctrl+Alt+W (Windows) or Shift+Command+Option+W (Mac OS).

[To the top](#)

Use anti-aliasing for smoothing edges

Anti-aliasing smooths the jagged edges of type and bitmap images by softening the color transition between edge pixels and background pixels. Since only the edge pixels change, no detail is lost.

1. Choose Edit > Preferences > Display Performance (Windows) or InDesign > Preferences > Display Performance (Mac OS).
2. From the Adjust View Settings menu, choose the view setting for which you want to turn on anti-aliasing.

You can enable or disable anti-aliasing for each of the view settings. For example, you can enable anti-aliasing for High Quality view and disable it for Fast view.

3. Select Enable Anti-aliasing.

[To the top](#)

Greek type

When display capabilities are insufficient to show text at a small size, InDesign displays the text as a dimmed bar. This behavior is called *greeking* type. Any type at or below the specified type size is replaced on-screen with non-letterforms that act as placeholders.

1. Choose Edit > Preferences > Display Performance (Windows) or InDesign > Preferences > Display Performance (Mac OS).
2. From the Adjust View Settings menu, choose the view setting for which you want to change the Greek Type setting.

You can specify different Greek Type values for each of the view settings.

3. For Greek Type Below, type a value, and then click OK.

To control whether to greek text and images when you scroll a document, open the Interface section of the Preferences dialog box, drag the Hand Tool slider to the desired level of performance versus quality, and then click OK.

[To the top](#)

Calculate values in panels and dialog boxes

You can perform simple math in any numerical edit box. For example, if you want to move a selected object 3 units to the right using the current measurement units, you don't have to work out the new horizontal position—simply type **+3** after the current value in the Transform panel.

Panels use the measurement system selected in the Preferences dialog box; however, you can specify values in another measurement instead.

1. In a text box that accepts numerical values, do one of the following:
 - To replace the entire current value with a mathematical expression, select the entire current value.
 - To use the current value as part of a mathematical expression, click before or after the current value.
2. Type a simple mathematical expression using a single mathematical operator, such as + (plus), - (minus), * (multiplication), / (division), or % (percent).

For example, 0p0+3 or 5mm + 4.

3. Press Enter or Return to apply the calculation.

 *In the Control panel and the Transform panel, you can duplicate the selected object and apply the calculation to the duplicate (instead of the original). Enter the calculation and press Alt+Enter (Windows) or Option+Return (Mac OS).*

[To the top](#)

Enter values in panels and dialog boxes

Panels and dialog boxes use the measurement units and increments defined in the Edit > Preferences > Units & Increments (Windows) or

InDesign > Preferences > Units & Increments (Mac OS) dialog box. However, you can specify values using any of the supported measurement units at any time by temporarily overriding the current preference settings.

- Do any of the following:
 - Type a value in the box, and then press Enter or Return.
 - Drag the slider.
 - Drag the dial.
 - Click the arrow buttons in the panel to change the value.
 - Click in the box and then use the up or down arrow keys on the keyboard to change the value.
 - Select a value from the menu associated with the box.

Note: *When you make a change using the arrow buttons, arrow keys, or pop-up menus, InDesign applies the change immediately.*

Adobe also recommends

 Twitter™ and Facebook posts are not covered under the terms of Creative Commons.

[Legal Notices](#) | [Online Privacy Policy](#)

Understanding a basic managed-file workflow

javax.jcr.AccessDeniedException: /content/help/en/indesign/using/basic-managed-file- workflow/jcr:content/jcr:title: not allowed to add or modify item

[Sharing content](#)

[Ways to work with content in InCopy](#)

[Managed files](#)

[Best practices for working with managed files](#)

[Managed-file workflow examples](#)

[Enter user identification](#)

[Workflow icons](#)

For detailed information and instructions, click the links below.

[To the top](#)

Sharing content

The Adobe InCopy LiveEdit Workflow plug-ins let writers and editors develop copy in InCopy at the same time as designers prepare layouts in Adobe InDesign. This workflow includes container files, called *assignments*, for grouping related pieces of content, and file-locking and notification tools for sharing and updating files in InCopy or InDesign over a shared network or in compressed packages that can be distributed via e-mail.

In the shared network workflow, InDesign users export text and graphics to a shared location on a file system, where the files become available to InCopy users who will write and edit the content. Selected text frames and graphics frames are either exported to the assignment or exported as separate InCopy files, where they become part of the managed process and are linked to the InDesign document. These shared files are referred to as *managed files*. When users work in the assignment file or in the InDesign file on a local server, changes to the associated layout or content are communicated to all users involved in the workflow for that document.

Multiple InCopy or InDesign users can open the same content file simultaneously, and multiple InCopy users can open the same assignment file simultaneously. However, only one user at a time can *check out* the InCopy file for editing. Others can view the file on a read-only basis. The user who checks out a managed InCopy file can share his or her work with other users by saving the file to the shared server or by returning the file to the InDesign user; however, other users can't make changes to the file until it's checked back in. This system allows multiple users to access the same file but prevents users from overwriting each other's work.

For more information, see the InCopy LiveEdit Workflow guide (PDF) at www.adobe.com/go/learn_liveedit.

[To the top](#)

Ways to work with content in InCopy

Content is either a body of text that flows through one or more frames, or an imported graphic. There are five basic ways to work on content in InCopy: open an assignment file, open an assignment package, open a linked InCopy file, open an InDesign file that has linked InCopy files, or compose content entirely in InCopy.

Open assignment files created in InDesign

InDesign users can create an assignment file and designate content for sharing. This method lets the InDesign user associate related components (heading, body, graphics, captions, and so on), and then assign them to different InCopy users for writing and editing. InCopy users open the assignment file and work on only the components assigned to them. The live layout view shows how their edited copy relates to the InDesign layout, without opening the entire InDesign document. However, if the layout changes, the InDesign user must update assignments to notify InCopy users about the changes. You can share assignment files on a server or through assignment packages.

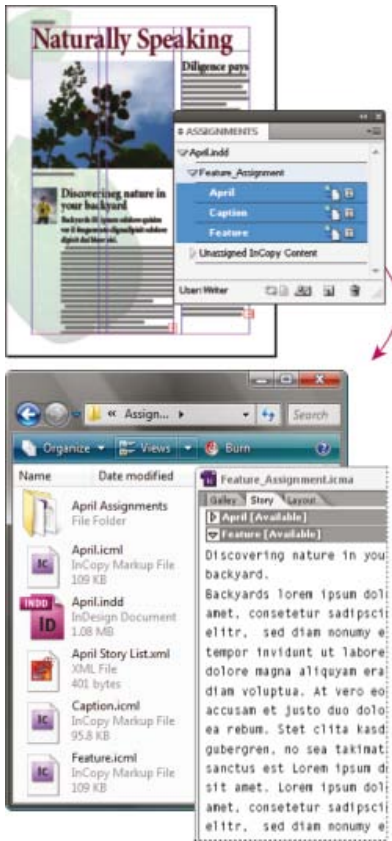

InDesign document (.indd) with assignment file (.icml) composed of three linked content files (.incx). Assignment and its components are listed in Assignments panel and are opened in InCopy.

Open assignment packages

The assignment packages workflow is especially useful when designers and writers are working on the same project but don't have access to a local server. In such cases, the InDesign user can create one or more packages and send the compressed files to the assigned InCopy users via e-mail. InCopy users can open the assignment packages, edit the contents, and return the packages to the InDesign user, who can then update the document.

Open linked InCopy files exported from InDesign

In certain workflows, InDesign users might export text and graphics as separate files, rather than wrapping them inside an assignment file. Exporting separate files is useful if you work on unrelated graphics or bodies of text. However, InCopy users aren't able to see how the content fits within the InDesign layout.



InDesign document (.indd) with three linked but unassigned content files (.icml) opened in InCopy

Open InDesign documents that have linked InCopy files

To see all page items in the context of an entire layout, InCopy users can open and edit an InDesign document in InCopy. This approach can be useful for editing and copyfitting if seeing the overall layout is important, or for editing most of the stories in a document rather than a few. After the InCopy user edits the stories, the InDesign user can then update the links to the modified files. If the InDesign user changes the layout, the InCopy user is notified when the InDesign document is saved.

Compose content entirely in InCopy

You can create content in InCopy that isn't associated with an InDesign file. In these stand-alone documents, you can type text, assign fonts and styles, and import graphics from other applications (such as Adobe Illustrator and Adobe Photoshop) to enhance the text. You can also assign tags for future XML use. This approach is a good option in an editorial workflow where the content precedes the design. You can also set up and modify the text area, page size, and orientation for stand-alone InCopy documents. But if the story is later linked to an InDesign document, the InDesign settings override the settings used in InCopy.

[To the top](#)

Managed files

For a file to be managed, it must be added to an assignment file, exported from InDesign as InCopy content, or placed as InCopy content into InDesign. Managed files communicate both content status and ownership. With managed files, you can:

- Lock and unlock stories to help preserve file integrity.
- Notify InCopy users when the associated InDesign layout is outdated.
- Identify the user working on a file.
- Notify users when an InCopy content file is outdated, being used by someone, or available for editing. Notification methods include alert messages, frame icons, status icons in the Links panel, and status icons in the Assignments panel.

Read-only files

Once a content file becomes managed, it's *read-only* to all users in the workflow at all times, except to the person who has checked it out. The software creates a lock file (*.idlk) when a user checks out a content file, giving that user exclusive editing control. Read-only files have the following characteristics:

- An InCopy user cannot manually format the text in it. However, if text has been assigned character or paragraph styles, an InDesign user can change the definition of those styles, thereby changing the formatting of the text even when the file is checked out to someone else. These style definition changes are reflected in the text once the InDesign user updates the file.
- In general, neither an InCopy nor InDesign user can change objects, such as text and applied styles, in locked InCopy content. Some objects, such as character and paragraph styles, are only *used* by the content. For example, you can't change how a character style is applied to objects in locked content, but you can change the character style itself, thereby changing the appearance of the text.
- An InDesign user can change the margins and columns of the text content as well as the shape, location, and number of text frames the story occupies.
- An InDesign user can change the geometry and formatting of a graphics frame without checking out the graphic. An InCopy user cannot change a graphics frame or any formatting on the frame. However, both InDesign and InCopy users have to check out the graphics frame in order to modify the graphic itself (for example, to rotate or scale it).

[To the top](#)

Best practices for working with managed files

Use the following practices to make sure that you work with the most up-to-date content and don't overwrite someone else's work:

- Store assignment files on a server where all team members have access. If team members don't have access to a server, you can create and distribute assignment packages.
- When you create an assignment, a special folder is created to hold the assignment file and the content. Use these assignment folders to maintain assignment and content files. They simplify managing the shared files across a workgroup and help ensure that users open the correct files.
- In InCopy, open the assignment file instead of an individual InCopy story. That way, you can see the copyfit and layout information in Galley and Layout views. If you export content without using assignment files, you can see copyfit and layout information only by opening the InDesign file.
- As soon as you open an assignment file, open an InDesign document, or check out content in either InDesign or InCopy; make sure that frame edges are showing (View > Extras > Show Frame Edges) so that you can see the frame icons when they appear.
- In InDesign, if you must remove files from the workflow (because of a production deadline, for example), you can unlink them or cancel an assignment package.

[To the top](#)

Managed-file workflow examples

When you establish workflow management between InCopy and InDesign, writers and editors can compose, rewrite, expand, and edit documents at the same time that designers prepare the layout. Common workflows include managing files on a local server, sharing files via e-mail packages, or using some combination of the two methods.

These workflows assume that you have a basic InDesign template with layout geometries, styles, and placeholder text. Layout geometries include page dimensions as well as text and graphics frames. InCopy uses these items to show proper copyfit information.

Local server workflow

1. In InDesign, create assignments and add content to them.

This step incorporates exported text and graphics frames into the managed process, where they become available to InCopy users for writing and editing.

2. Make the assignment files available to InCopy users.

Save the files to a server that all workflow users have access to.

3.In InCopy, open the assignment file, and check out and edit a story or graphic.

In InCopy, the files containing content assigned to you appear in the Assignments panel. Whenever you save the file on a local server, the changes are saved on the file system and anyone working on that document (the InDesign layout or another managed content file in the document) receives notification of the changes. Those users can update the content to view the latest changes. The content remains checked out to you until you check it in.

4.In InDesign, work on the layout.

Regardless of whether the content files are being edited in InCopy, InDesign users can work on the document layout; they don't have to check out the document. Whenever the InCopy user saves the checked-out content, the InDesign user can update that content within the layout to see the latest revisions.

5.In InCopy, continue working.

When finished with your edits, check in the content. Other users are then able to check out the content and work on it. If a user is modifying the layout in InDesign simultaneously, you can update and view the layout geometry as you work.

6.In InDesign, make sure that all the content is checked in.

The managed workflow makes it possible to know who has checked out files. After content files are checked in, InDesign users can check out the files to finalize the layout as necessary.

E-mail package workflow

1.In InDesign, create and send assignment packages.

Create assignment packages and assign contents to the appropriate InCopy users, and then send the packages to the InCopy users. The packaged files are automatically checked out to help avoid editing conflicts.

2.In InCopy, open the assignment package, and check out and edit a story or graphic.

If you receive an assignment package in e-mail, double-click the package to open it in InCopy. Changes you make to the file are saved only locally. Other users are not notified when you make changes.

3.In InDesign, work on the layout.

Regardless of whether the content files are packaged, InDesign users can work on the document layout; they don't have to check out the document. If you need to update the layout or assignments, you can send an updated package to the InCopy users.

4.In InCopy, return the edited package.

When finished with your edits, check in the content and return the modified package. Other users are then able to check out the content, view the latest revisions, and work on the file.

5.In InDesign, make sure that all the content is checked in.

The managed workflow makes it possible to know who has checked out files. After assignment packages are returned, stories in assignment packages are checked in. InDesign users can check out the files to finalize the layout as necessary.

[To the top](#)

Enter user identification

All users in the workflow must have a user name. This identification reveals who has checked out a particular file and makes this information available to other users. It's also required in order to check out a file for editing.

If you've already specified a user name and want to change it, you must check in any content you have checked out. Otherwise, changing user identification during an editing session would forfeit your ability to edit content that you have checked out—it would be checked out to you under a different name.

User identification is application-specific; no single user can have multiple user identifications per application.

Note: *The InCopy Notes and Track Changes features also use the specified name to identify the author of a note or a tracked change.*

1. Do either of the following:

- Choose File > User.
- Choose User from the Assignments panel menu.

2. Type a unique name and click OK.

If you forget to specify a user name using this method, you're prompted to enter one when you attempt your first workflow action.





Note: *The Color pop-up menu in this dialog box is for identifying editorial notes and tracked changes. You can choose the color now if you want, but it doesn't affect anything you do in a managed workflow.*







[To the top](#)

Workflow icons

Icons can appear on text and graphics frames, the Assignments panel, and in the story bar (InCopy only). Edit status icons appear next to the managed file in the Links panel and Assignments panel, and communicate content status. Icons appear on frames that contain a linked InCopy story (in the Layout view in both InDesign and InCopy). These icons also communicate content status and can be used to differentiate between managed and unmanaged content. The associated tool tip indicates editing status and ownership. To view the frame icons, make sure that frame edges are showing in InDesign and InCopy (View > Extras > Show Frame Edges).

Note: *(InDesign) The InDesign document window must be in Normal Mode for the frame edges to show. (Click the Normal Mode button  at the lower left of the toolbox.)*

Icon	Name	Location
	Available	Assignments panel (InDesign and InCopy), text frames, and graphics frames
	In Use By <i>[name]</i>	Assignments panel, text frames, and graphics frames
	Editing	Assignments panel, text frames, and graphics frames
	Available And Out Of Date	Text and graphics frames
	In Use By <i>[name]</i> And Out Of Date	Text and graphics frames

	Editing And Out Of Date	Text and graphics frames
	Out Of Date	Assignments panel
	Text Content Out Of Date	Assignments panel and text frames
	Text Content Up To Date	Assignments panel and text frames
	Graphics Content Out Of Date	Assignments panel and graphics frames
	Graphics Content Up To Date	Assignments panel and graphics frames
	Packaged Content	Assignments panel

Note: The Out Of Date icon on the Available, In Use, Editing, Text Content, and Graphics Content icons indicates that the content is out of date; that is, the version on the file system is newer than the version displayed on your computer.

Adobe also recommends

- Work with stand-alone documents
- Using editorial notes

 Twitter™ and Facebook posts are not covered under the terms of Creative Commons.

[Legal Notices](#) | [Online Privacy Policy](#)

Toolbox

[Toolbox overview](#)

[Tools overview](#)

[Gallery of selection tools](#)

[Gallery of drawing and type tools](#)

[Gallery of transformation tools](#)

[Gallery of modification and navigation tools](#)

[To the top](#)

Toolbox overview

Some tools in the toolbox are for selecting, editing, and creating page elements. Other tools are for choosing type, shapes, lines, and gradients. You can change the overall layout of the toolbox to fit your preferred window and panel layout. By default, the toolbox appears as a single vertical column of tools. You can also set it up as a double vertical column or as one horizontal row. However, you can't rearrange the positions of individual tools in the toolbox. You can drag the top of the toolbox to move it.

Select a tool from the default toolbox by clicking it. The toolbox also contains several hidden tools related to the visible tools. Hidden tools are indicated by arrows to the right of the tool icons. Select a hidden tool by clicking and holding the current tool in the toolbox and then selecting the tool that you want.

The name of the tool and its keyboard shortcut appear when you hold the pointer over the tool—this text is called the *tool tip*. You can turn off tool tips by choosing None from the Tool Tips menu in Interface preferences.

 Open the *Tool Hints* panel (choose *Window > Utilities > Tool Hints*) to see which shortcut and modifier keys work with the selected tool.

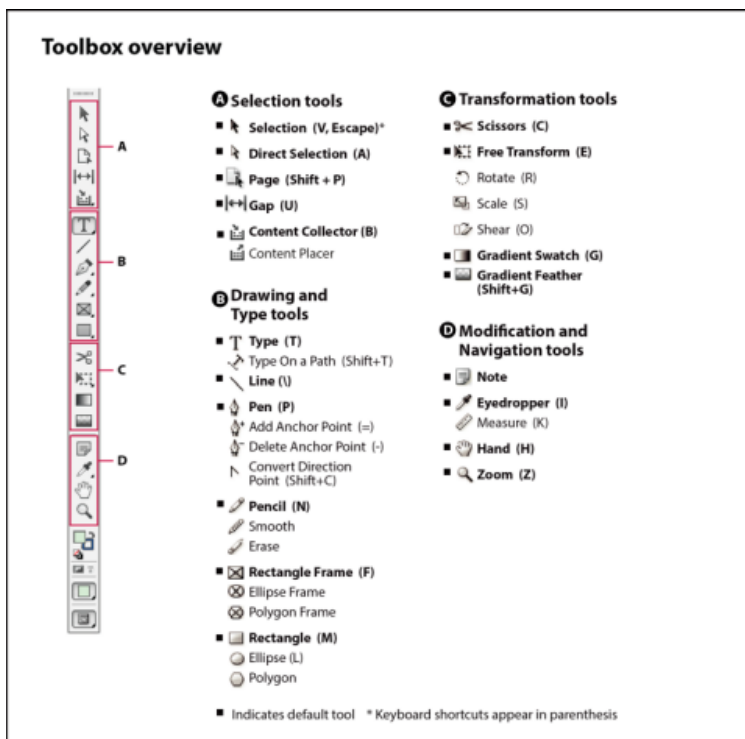

Note: *Content Collector* and *Content Placer* tools are not available in CS5.5 or earlier.

Display the toolbox

- Choose Window > Tools.

Display tool options

- Double-click a tool in the toolbox.

This procedure works only for some tools, such as the Eyedropper, Pencil, and Polygon tools.

Display and select hidden tools

1. In the toolbox, position the pointer over a tool that has hidden tools and hold down the mouse button.
2. When the hidden tools appear, select a tool.

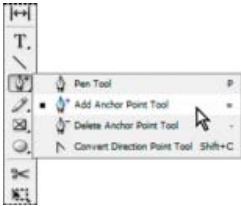

Hidden tools menu

Select tools temporarily

1. When one tool is selected, hold down the keyboard shortcut of a different tool.
2. With the keyboard shortcut still held down, perform an action.
3. Release the keyboard shortcut to return to the previous tool.

For example, if the Gap tool is selected, hold down the V key to temporarily use the Selection tool. When you release the V key, the Gap tool is selected.

View tool hints

The Tool Hints panel describes how modifier keys work with the selected tool.

1. Choose Window > Utilities > Tool Hints to display the Tool Hints panel.
2. Select a tool in the toolbox to view a description of that tool and its modifier keys and shortcuts.

Change the toolbox layout

1. Choose Edit > Preferences > Interface (Windows) or InDesign > Preferences > Interface (Mac OS).
2. Choose a layout option from the Floating Tools Panel menu and click OK.

You can also click the double arrow icon at the top of the toolbox to change the toolbox layout.

[To the top](#)

Tools overview

Type tools Create and format type in standard or customized blocks or paths. (See Create text frames.)

Drawing tools Draw and style simple and complex objects, including rectangles, ellipses, polygons, freeform shapes. (See Drawing.)

Selection tools Select (activate) objects, points, or lines. (See Selecting objects.)



Transform tools Reshape, reorient, and resize objects. (See Transforming objects.)

Navigation tools Move around in, control the view of, and measure distances in a document. (See Zoom in and out and Rulers and measurement units.)

The Scissors tool Splits paths and frames. (See Split a path.)

[To the top](#)

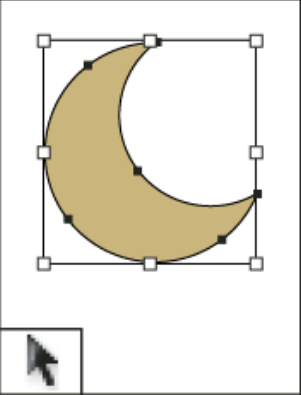
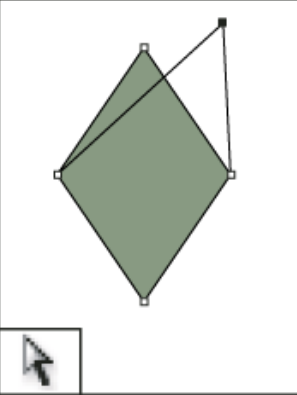
Gallery of selection tools

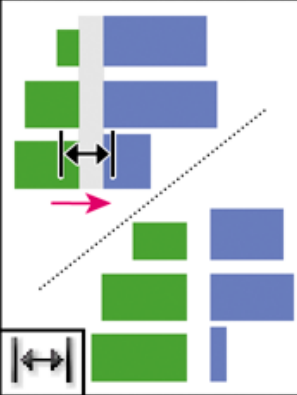
			
<p><i>Selection tool lets you select entire objects.</i></p>	<p><i>Direct Selection tool lets you select points on a path or contents within a frame.</i></p>	<p><i>Page tool lets you create multiple page sizes within a document.</i></p>	<p><i>Gap tool lets you adjust the space between objects.</i></p>

[To the top](#)

Gallery of drawing and type tools



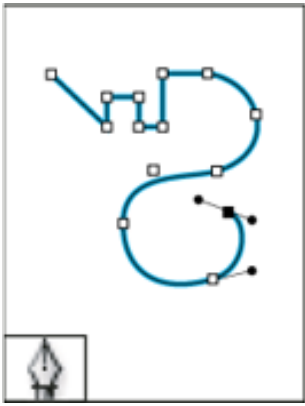

Pen tool lets you draw straight and curved paths.

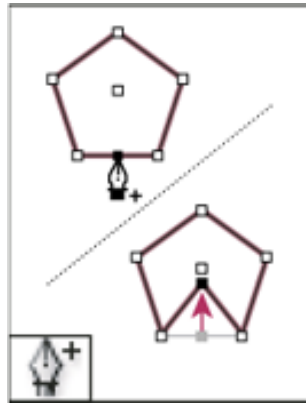

Add Anchor Point tool lets you add anchor points to a path.

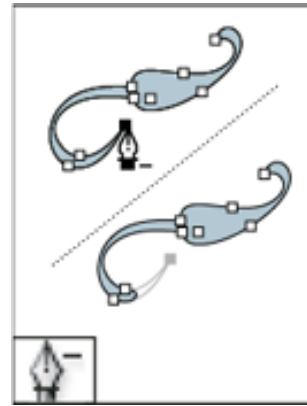

Delete Anchor Point tool lets you remove anchor points from a path.

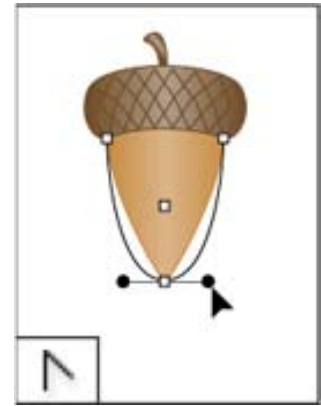

Convert Direction Point tool lets you convert corner points and smooth points.

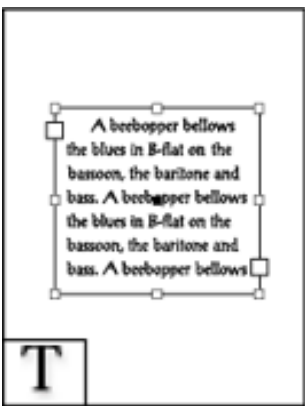

Type tool lets you create text frames and select text.



Type on a Path tool lets you create and edit type on paths.

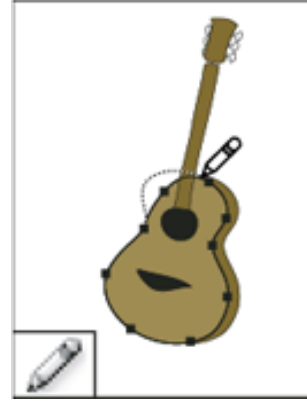

Pencil tool lets you draw a freeform path.

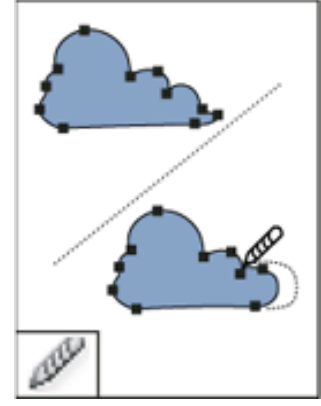

Smooth tool lets you remove excess angles from a path.



Vertical Type tools lets you create vertical text frames and select text.

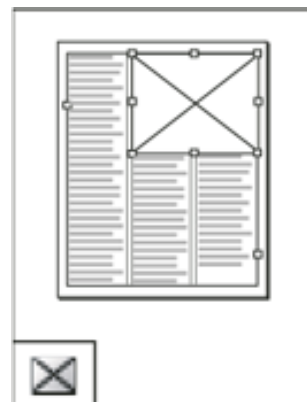
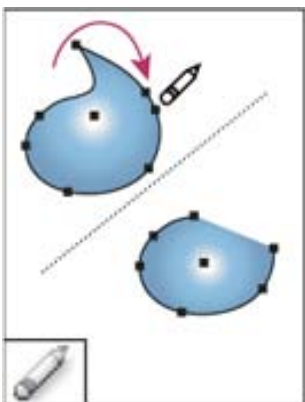

Erase tool lets you delete points on a path.

Line tool lets you draw a line segment.

Rectangle Frame tool lets you create a square or rectangle placeholder.

Ellipse Frame tool lets you create a circle or oval placeholder.

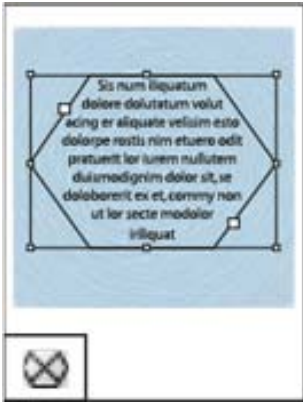

Polygon Frame tool lets you create a multi-sided shape placeholder.

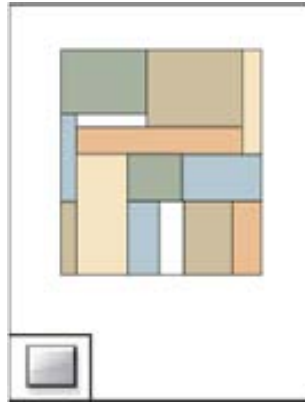

Rectangle tool lets you create a square or rectangle.

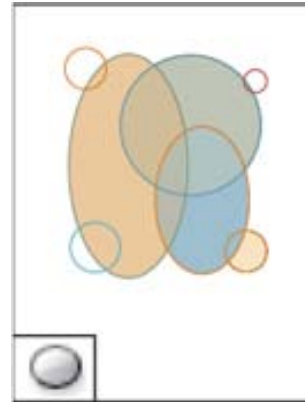

Ellipse tool lets you create a circle or oval.

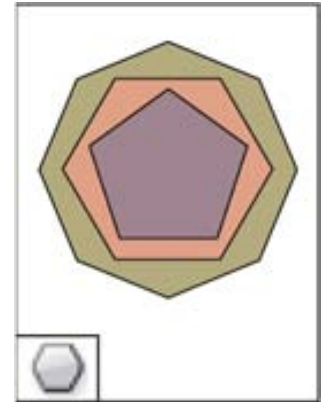

Polygon tool lets you create multi-sided shape.

[To the top](#)

Gallery of transformation tools



Free Transform tool lets you rotate, scale, or shear an object.

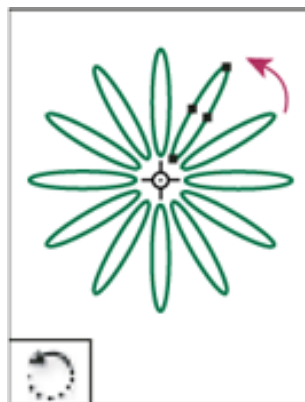

Rotate tool lets you rotate objects around a fixed point.

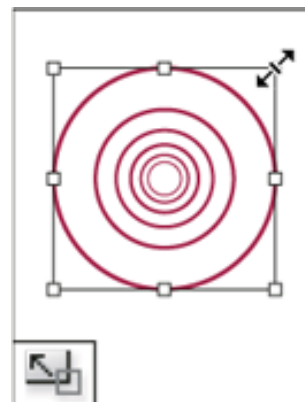

Scale tool lets you resize objects around a fixed point.

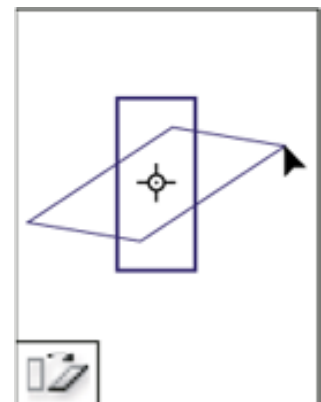

Shear tool lets you skew objects around a fixed point.

[To the top](#)

Gallery of modification and navigation tools

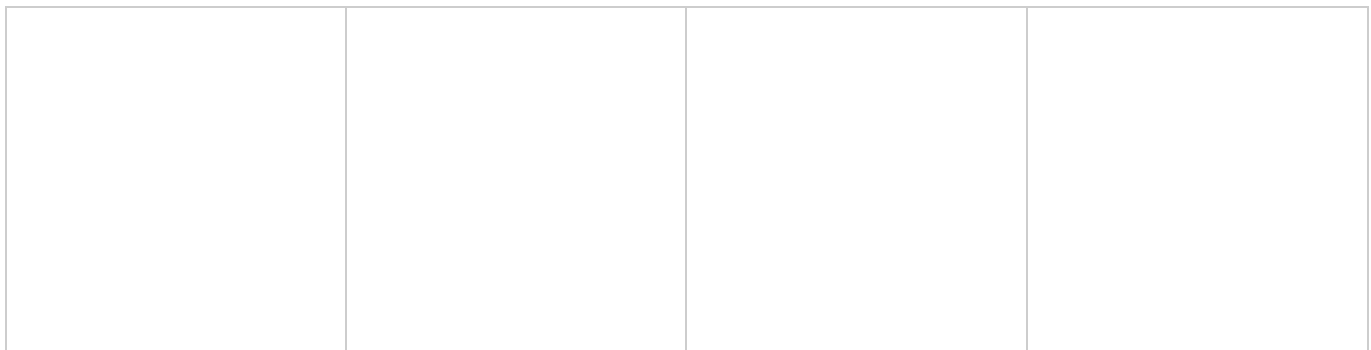

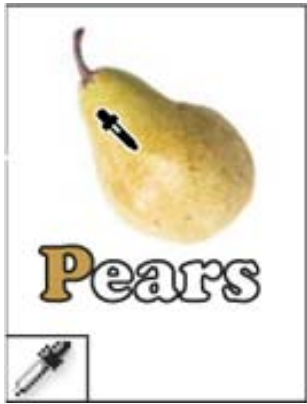

Eyedropper tool lets you sample color or type attributes from objects and apply them to other objects.

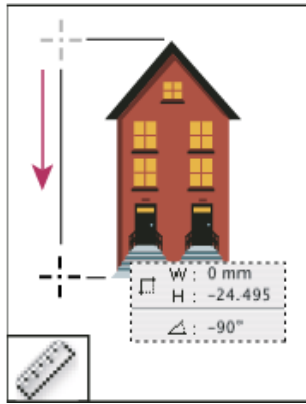

Measure tool measures the distance between two points.

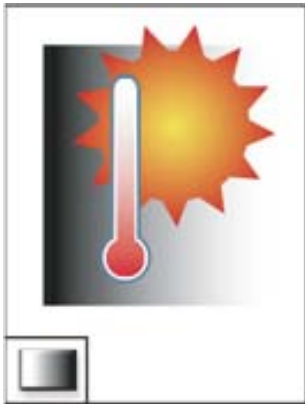

Gradient Swatch tool lets you adjust the beginning and ending points and angle of gradients within objects.

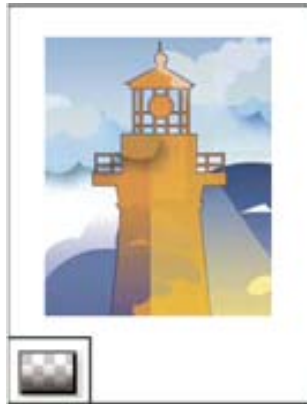

Gradient Feather tool lets you fade an object into the background.

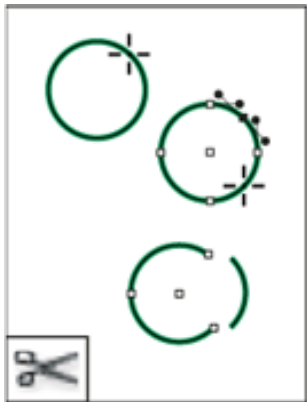

Scissors tool cuts paths at specified points.



Hand tool moves the page view within the document window.



Zoom tool increases and decreases the view magnification in the document window.



Note tool lets you add comments.

Adobe also recommends

 Twitter™ and Facebook posts are not covered under the terms of Creative Commons.

[Legal Notices](#) | [Online Privacy Policy](#)

Sharing content

[Exporting content from InDesign](#)

[Assignments panel overview](#)

[Assignment files](#)

[Create assignments and add content \(InDesign\)](#)

[Export content as separate InCopy files \(InDesign\)](#)

[To the top](#)

Exporting content from InDesign

Exporting content from InDesign to InCopy establishes a link between the two applications. You export InDesign text frames, graphics frames, and their contents to InCopy using either of two methods:

- Create a container file (*.icma)—called an *assignment*—and add related groupings of document items (such as the text and graphics of a story) to the assignment so they can be worked on together. Content within assignments is exported as *.icml files.
- Export text and graphics frames separately (including placeholder frames) using the Edit > InCopy > Export menu commands. Exported content is saved as *.icml files.

After content is exported, small icons appear at the top left of exported frames in InDesign and InCopy, and in the Assignments panel. A link to the exported file appears in the Links panel. These icons indicate the status of managed frames and they differentiate managed frames from those that aren't part of the workflow. All exported content appears in the Assignments panel. Content exported using the Export menu commands appears in the Unassigned InCopy Content section of the Assignments panel list. While both methods establish a controlled connection between InCopy content and an InDesign document, the primary method is to use assignment files.

Exporting content makes the content available for users to check out while maintaining a link to the original InDesign document. (This link is made from within InDesign; you cannot create the link from InCopy.)

Once the content is exported, InCopy users can see (but not change) the page layouts, styles, and so forth as they appear in the InDesign document.

Note: *You can also create text or anchored graphics using InCopy and then place them in InDesign.*

[To the top](#)

Assignments panel overview

The primary tool for working with assignments is the Assignments panel (Window > Assignments in InCopy, Window > Editorial > Assignments in InDesign). The Assignments panel displays the files exported from the currently active InDesign document, and an icon indicates their status. The Assignments panel menu also contains commands that control import version and file-management functions between InCopy and InDesign. When you open an assignment in InCopy, the assignment name and its contents appear in the Assignments panel. You can double-click text and graphics frames in the Assignments panel to select them in the document window.

Note: *All content exported to InCopy or added to an assignment is also listed in the Links panel. Although you can do some workflow management tasks, such as checking out and checking in content, the recommended panel for these tasks is the Assignments panel.*

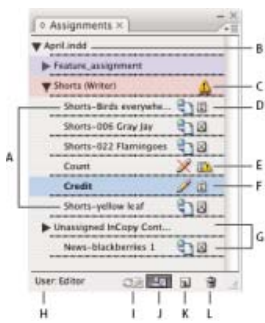

InDesign Assignments panel

A. InCopy content names **B.** InDesign document name **C.** Assignment Out Of Date status **D.** Available And Text Up To Date status **E.** In Use And Text Out Of Date status **F.** Editing And Text Up To Date status **G.** Unassigned content **H.** User name **I.** Update Content button **J.** Check Out/Check In Selection button **K.** New Assignment button **L.** Delete Selected Assignments/Remove button

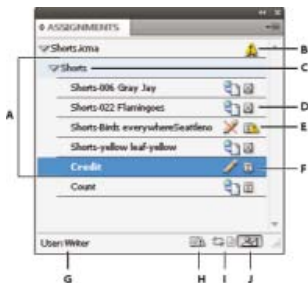

InCopy Assignments panel

A. InCopy content names **B.** Assignment Out Of Date status **C.** Assignment name **D.** Available And Text Up To Date status **E.** In Use And Text Out Of Date status **F.** Editing And Text Up To Date status **G.** User name **H.** Update Design button **I.** Update Content button **J.** Check Out/Check In Selection button

[To the top](#)

Assignment files

In InDesign, assignment files are containers for organizing collections of page items. For example, you might want to select all the items in a story (headline, byline, copy, graphics, and captions), and then assign them to one InCopy user. Adding those items to an assignment provides a convenient way for InCopy users to access only the content for which they are responsible. Assignment files (*.icma) appear in the file system, in the InCopy story bar, and in status messages. Only InDesign users can create assignment files; only InCopy users can open them.

When you create an assignment, a folder is created in the same location as the InDesign document by default. This assignment folder includes the *.icma assignment files and a content subfolder that contains any exported InCopy story files (in .icml format) that are part of images or other resources. Once the assignment is created, store the project folder in a location where all users have access to it, or create and distribute an assignment package. If content is exported before it's added to an assignment, the files on disk are not moved to the content folder of the assignment file.

Assignment files include the following:

- Links or pointers to the associated page items, including placeholder frames. These elements let the InCopy user open a single file in InCopy and have editorial access to multiple page items.
- Any transformations on the graphics included in the assignment, such as moving, scaling, rotating, or shearing.
- Page geometry, so InCopy users can see the layout of the frame and its content that they're editing without opening the entire InDesign file.
- Color-coding of assigned frames in the document.



Illustration of page in InCopy showing page geometry and color coding

[To the top](#)

Create assignments and add content (InDesign)

Only InDesign users can create assignments and add content to them. There are several ways to create assignments. The method you choose usually depends on whether you have content to add at the time you create the assignment.

- Create empty assignment files. From your InDesign document, you can create a series of empty assignments to act as templates for content to come later.
- Create assignments and add content at the same time.
- Add content to an existing assignment file. You can add linked content—text and graphics that have already been exported as InCopy content—or you can add selected page items to become linked InCopy content. If one or more of the selected frames already contain InCopy content files, and none is part of an assignment, you can add them to a new or existing assignment file.

By default, the assignment folder you create is saved in the same folder as the InDesign document. You can then place this folder on a server or create and send a package.

Note: *If you don't want InCopy users to place and fit graphics, don't add graphics frames to an assignment.*

Create empty assignment files (InDesign)

1. In InDesign, save the document.
2. In the Assignments panel, choose New Assignment from the panel menu.
3. In the New Assignment dialog box, specify assignment file options and click OK.

Simultaneously create assignments and add content (InDesign)

1. In InDesign, create a document that has one or more text frames, graphics frames, or placeholder items, and then save the document.
2. Select the text and graphics frames you want to add.
3. Do one of the following:
 - From the Assignments panel menu, choose Add To Assignment, and then select New.
 - Choose Edit > InCopy > Add [option] To Assignment > New.

4. In the New Assignment dialog box, specify assignment file options and click OK.

The newly created assignment file includes any frames selected in the document window.

Add content to existing assignments (InDesign)

1. Save the InDesign document.
2. Select the text and graphics frames you want to add.
3. Do one of the following:
 - From the Assignments panel menu, choose Add To Assignment, and then select the assignment.
 - Drag content from the Unassigned InCopy Content section of the Assignments panel into an existing assignment.
 - Select page items with the Selection tool and drag them to an existing Assignment in the Assignments panel.
 - Choose Edit > InCopy > Add [option] To Assignment, and then select the assignment.
4. Choose Update All Assignments from the Assignments panel menu to make the content files available to InCopy users.

Note: You can add content only to assignments in the same document. However, you can import the same content into multiple documents and add it to an assignment in each of those documents.

Assignment file options (InDesign)

When you create or modify an assignment file, you can set the following options:

Assignment Name The unique identification of the assignment in the Assignments panel, for example "Ocean article." This name must conform to the file naming conventions of the operating system.

Assigned To The unique identification of the user assigned to the files. The user's name appears in parentheses following the assignment name in the Assignments panel. Entering a name here is for informational purposes only; it doesn't grant special rights or permissions to the user.

Color Displays a list of colors for adding a distinctive highlight to the frames of the current assignment in the document window, and to the assignment names in the Assignments panel. This color coding differentiates frames that belong to one assignment from frames that belong to another, and it differentiates from unassigned frames. To toggle the display of this color coding, choose View > Extras > Show/Hide Assigned Frames. In InCopy, the color coding is visible only in Layout view.

Note: If toggling the display of assigned frames produces unexpected results, those frames might be tagged for XML and View > Structure > Show Tagged Frames might be enabled. You cannot show assigned frames and tagged frames at the same time.

Change Click the Change button to specify the location of the assignments folder. By default, the assignments folder is created in the same location as the InDesign file.

Placeholder Frames Lets InCopy users see the text and graphics frames in the assignment as well as boxes (or other shapes) representing all other frames on those InDesign pages. All frames and placeholders accurately reflect the size, shape, and location of the InDesign originals. Placeholder frames are empty shapes that don't show any of the content in the InDesign document. The Placeholder Frames option provides the least amount of fidelity, and therefore provides the fastest performance. In InCopy, the placeholder frames are visible only in Layout view. InCopy users cannot check out and edit placeholder frames.

Assigned Spreads Lets InCopy users see all assigned frames, as well as the entire contents of other frames that aren't part of the assignment, on the same spread. In InCopy, content in frames outside an assignment isn't editable and is visible only in Layout view.

All Spreads Exports all content in the InDesign document to the assignment file. This option provides the maximum amount of fidelity; it also provides the slowest performance because the assignment file displays the design and layout of every page, including pages not relevant to the section a user is editing.

Linked Image Files When Packaging Includes a copy of linked images in the assignment package. Selecting this option gives InCopy users access to images but increases the package's file size. InCopy users can include images while returning a package.

[To the top](#)

Export content as separate InCopy files (InDesign)

If your workgroup prefers working with separate files rather than using assignments, you can export InCopy content without using an assignments file. Compared with creating a single assignment file with references to multiple content files and layout information, this method creates a separate file (.icml) for each text or graphics frame you specify in the document. To see the context of the content you are editing, you must also open the associated InDesign document (.indd).

Cater the InDesign document to suit your workflow needs. For example, if you want all of the editor's comments to be exported in a single file, create a layer for the editor to make comments. You can then export all the content on the selected layer.

Note: *A quick way to export content as separate InCopy files is to use the Selection tool to drag selected frames into the Unassigned InCopy Content in the Assignments panel.*

1. In InDesign, create a document with one or more text frames, graphics frames, or placeholder items.
2. Do either of the following:
 - Select the text or graphics frame of a single story, or Shift-click to select multiple frames.
 - Click an insertion point in a story, or select some text in a text frame.
3. Choose Edit > InCopy > Export, and then choose one of the following options:

Selection Exports all selected text and graphics frames.

Layer Exports all content on the selected layer.

All Stories Exports every story that has not been exported already.

All Graphics Exports every graphic that has not been exported already.

All Graphics And Stories Exports every story and graphic that has not been exported already.

 *If you export all content in the document, and then add more text or graphics frames to the same document, you can save time exporting the new ones by using the Export > All Stories (or All Graphics or All Graphics And Stories) command again. InDesign exports only the new content.*

4. Enter a name and location for the files, and then click Save.

The file name you specify is used as a prefix for identifying each exported content file in the file system. If you export multiple text frames, the first several characters of the text are automatically appended to the file name; for example, "mystory-Upcoming cycling events.icml." For multiple graphics frames, the file names are formed as "mystory-graphic," "mystory-graphic-1," and so on. The file name appears in the file system, in the InCopy story bar, and in status messages.

5. When prompted, save your InDesign file.

The InCopy content is now managed, and is available to be checked out and edited by other users in the workflow.

Shared content appears in the Links panel just like imported graphics. If you move a shared file manually, you can use the Links panel to update its link.

 *When you export content, you see the Available icon on the text frame (InDesign and InCopy), and in the Assignments panel (InCopy). The word [Editing] appears in the story bar (InCopy).*

Adobe also recommends

 Twitter™ and Facebook posts are not covered under the terms of Creative Commons.

[Legal Notices](#) | [Online Privacy Policy](#)

Saving documents

Save documents

Save backwards to the previous InDesign version

Work with metadata

[To the top](#)

Save documents

Saving a document saves the current layout, references to source files, which page is currently displayed, and the zoom level. Protect your work by saving often. You can save a file as any of the following:

- A regular document.
- A copy of the document, which creates a duplicate of the document under a different name, leaving the original document active.
- A template, which normally opens as an untitled document. A template can contain settings, text, and graphics that you preset as a starting point for other documents.

Saving a document also updates the metadata (or file information) that is part of the InDesign document. This metadata includes a thumbnail preview, fonts used in the document, color swatches, and all metadata in the File Info dialog box, all of which enable efficient searching. For example, you might want to search for all documents that use a particular color.

You can view this metadata in Bridge and in the Advanced area of the File Info dialog box. You can control whether to update the preview when you save by using a preference setting. The other metadata (fonts, colors, and links) are updated whenever you save a document.

The Save, Save As, and Save a Copy commands store documents in the InDesign file format. For information about storing documents in other file formats, see the Index.

If you're saving a document in order to bring it to a prepress service provider for final output, InDesign can automatically collect all necessary files, such as linked graphics and fonts, in one folder. (See Package files.)

- Do one of the following:
 - To save a document under a new name, choose File > Save As, specify a location and filename, and click Save. The newly named file becomes the active document. Using the Save As command might reduce the file size.
 - To save an existing document under the same name, choose File > Save.
 - To save all open documents to their existing locations and filenames, press Ctrl+Alt+Shift+S (Windows) or Command+Option+Shift+S (Mac OS).
 - To save a copy of a document under a new name, choose File > Save a Copy, specify a location and filename, and click Save. The saved copy does not become the active document.

Note: To avoid problems, avoid reserved characters that have special meanings in some operating systems. For example, avoid filenames with spaces, tabs, or initial periods, or filenames that use these characters: / \ : ; * ? < > , \$ %. Similarly, avoid using characters with accents (such as ü, ñ, or é), even when using a non-English version of InDesign. Problems may occur if the file is opened in a different platform.

 If you have frequently work with several documents open at the same time and want to save them all at once, use a keyboard shortcut. Choose Edit > Keyboard Shortcuts, choose Views, Navigation from the Product Area menu, and select Save All in the Commands list. You can then edit or add a shortcut. You can use Quick Apply to specify the Save All command.

Include previews in saved documents

Thumbnail previews of documents and templates provide easy identification of those files in Adobe Bridge and Adobe Mini Bridge. A preview is created when you save a document or template. A document preview includes a JPEG image of only the first spread; a template preview includes

a JPEG image of each page in the template. You can control the size of the preview and the number of pages to suit your needs. For example, Extra Large 1024x1024 enables you to quickly scan the contents of a page at high-resolution before you open the file.

You can enable the option in Preferences or in the Save As dialog box. Because previews increase both file size and the time it takes to save the document, you may prefer to enable the option on demand using the Save As dialog box.

1. Do one of the following:

- To include a preview every time you save a document, choose Edit > Preferences > File Handling (Windows) or InDesign > Preferences > File Handling (Mac OS).
- To include a preview for a specific document, choose File > Save As.
- To include a preview for a specific document, choose File > Save Content As.

2. Select Always Save Preview Images With Documents.

3. If you are setting the preview using the Preferences dialog box, choose the number of preview pages from the Pages menu, and choose an option from the Preview Size menu.

Note: Selecting the preview option in the Save As dialog box also selects the option in the Preferences dialog box, and uses the default Pages and Preview Size settings.

Save an InDesign Markup (IDML) document

In some cases you may want to save an InDesign in interchange markup format. It's especially useful to save in this format when you open a QuarkXPress or PageMaker publication in InDesign, when you open a document created in a previous version of InDesign, or when you're experiencing problems with your document, such as not being able to delete color swatches.

1. Choose File > Save (CS6) or File > Export (CS5).
2. From the Save As Type (Windows) or Format (Mac OS) menu, choose InDesign Markup (IDML).
3. Click Save.

You can open the saved IDML file in InDesign CS5 and InDesign CS4 but not in any previous version of InDesign.

For information on using IDML for development purposes, see www.adobe.com/go/learn_id_indesignmarkup_cs4_en.

[To the top](#)

Save backwards to the previous InDesign version

To open an InDesign CS6 document in InDesign CS5, in InDesign CS6, Save (File > Save) the document to the InDesign Markup Language (IDML). (The IDML format replaces the Interchange INX format used for saving backwards in previous versions.)

To open an InDesign CS5 document in InDesign CS4, in InDesign CS5, export (File > Export) the document to the InDesign Markup Language (IDML). (The IDML format replaces the Interchange INX format used for saving backwards in previous versions.)

Ensure that the computer running the previous version of InDesign is updated with the appropriate plug-ins so that it can open the exported IDML file. The person running the previous version of InDesign can obtain the compatibility plug-ins by choosing Help > Updates and following the prompts. Plug-ins can also be installed from the Adobe website: Visit [Product updates](#) page on the Adobe website, and choose InDesign from the product list.

Opening a document in a previous version of InDesign is also referred to as "saving down."

Note: Content created using features specific to the later version of InDesign may be modified or omitted when you open the document in a previous version of InDesign.

1. Choose File > Save (CS6) or File > Export (CS5).

2. From the File Type (Windows) or Format (Mac OS) menu, choose InDesign Markup (IDML).
3. Click Save.

You can open the .idml file in previous version of InDesign to convert it to an untitled InDesign document.

Note: To open the InDesign CS5 document in InDesign CS3, open the exported IDML file in InDesign CS4, save it and export it to InDesign CS3 Interchange (INX), and then open the exported INX file in InDesign CS3. Make sure that all InDesign versions are up to date.

[To the top](#)

Work with metadata

Metadata is a set of standardized information about a file, such as author name, resolution, color space, copyright, and keywords applied to it. You can use metadata to streamline your workflow and organize your files.

About the XMP standard

Metadata information is stored using the Extensible Metadata Platform (XMP) standard, on which Adobe Bridge, Adobe Illustrator, Adobe InDesign, and Adobe Photoshop are built. XMP is built on XML, and in most cases the metadata is stored in the file. If it isn't possible to store the information in the file, metadata is stored in a separate file called a *sidecar file*. XMP facilitates the exchange of metadata between Adobe applications and across publishing workflows. For example, you can save metadata from one file as a template, and then import the metadata into other files.

Metadata that is stored in other formats, such as Exif, IPTC (IIM), GPS, and TIFF, is synchronized and described with XMP so that it can be more easily viewed and managed. Other applications and features also use XMP to communicate and store information such as version comments, which you can search using Adobe Bridge.

In most cases the metadata remains with the file even when the file format changes, for example, from PSD to JPG. Metadata is also retained when files are placed in an Adobe document or project.

 You can use the XMP Software Development Kit to customize the creation, processing, and interchange of metadata. For example, you can use the XMP SDK to add fields to the File Infodialog box. For more information on XMP and the XMP SDK, visit the Adobe website.

Working with metadata in Adobe Bridge and Adobe Creative Suite components

Many of the powerful Adobe Bridge features that allow you to organize, search, and keep track of your files and versions depend on XMP metadata in your files. Adobe Bridge provides two ways of working with metadata: through the Metadata panel and through the File Infodialog box (InDesign) or the Content File Info dialog box (InCopy).

In some cases, multiple views exist for the same metadata property. For example, a property may be labeled Author in one view and Creator in another, but both refer to the same underlying property. Even if you customize these views for specific workflows, they remain standardized through XMP.

Add metadata using the File Info dialog box

The File Info dialog box displays camera data, file properties, an edit history, copyright, and author information of the current document. The File Info dialog box also displays custom metadata panels. You can add metadata directly in the File Information dialog box. Any information you enter in a field overrides existing metadata and applies the new value to all selected files.

1. Choose File > File Info (InDesign) or File > Content File Info (InCopy).
2. Select any of the following from the tabs at the top of the dialog box:

 Use the Right and Left arrows to scroll the tabs, or click the down-pointing arrow and choose a category from the list.

Description Lets you enter document information about the file, such as document title, author, description, and keywords that can be used to search for the document. To specify copyright information, select Copyrighted from the Copyright Status pop-up menu. Then enter the copyright owner, notice text, and the URL of the person or company holding the copyright.

IPTC Includes four areas: IPTC Content describes the visual content of the image. IPTC Contact lists the contact information for the photographer. IPTC Image lists descriptive information for the image. IPTC Status lists workflow and copyright information.

Camera Data Includes two areas: Camera Data 1 displays read-only information about the camera and settings used to take the photo, such as make, model, shutter speed, and f-stop. Camera Data 2 lists read-only file information about the photo, including pixel dimensions and resolution

Video Data Lists information about the video file, including video frame width and height, and lets you enter information such as tape name and scene name.

Audio Data Lets you enter information about the audio file, including the title, artist, bit rate, and loop settings.

Mobile SWF Lists information about mobile media files, including title, author, description, and content type.

Categories Lets you enter information based on Associated Press categories.

Origin Lets you enter file information that is useful for news outlets, including when and where the file was created, transmission information, special instructions, and headline information.

DICOM Lists patient, study, series, and equipment information for DICOM images.

History Displays Adobe Photoshop history log information for images saved with Photoshop. The History tab appears only if Adobe Photoshop is installed.

Illustrator Lets you apply a document profile for print, web, or mobile output.

Advanced Displays fields and structures for storing metadata by using namespaces and properties, such as file format and XMP, Exif, and PDF properties.

Raw Data Displays XMP text information about the file.

3. Type the information to add in any displayed field.
4. Click OK to apply the changes.

Export metadata as an XMP file

You can save metadata in an XMP file to share with other users. These XMP files can be used as templates for populating InDesign documents and other documents created with XMP-enabled applications. Templates you export are stored in a shared location that all XMP-enabled applications can access. They also appear in the pop-up menu at the bottom of the File Info dialog box.

1. Choose File >File Info (InDesign) or File > Content File Info (InCopy).
2. Choose Export from the pop-up menu at the bottom of the dialog box.

3. Type a filename, choose a location for the file, and click Save.

 To view metadata templates in Explorer (Windows) or the Finder (Mac OS), click the pop-up menu at the bottom of the File Info dialog box and choose Show Templates Folder.

Import metadata from an XMP file

When you import metadata into a document from an exported XMP template file, you can specify whether to clear all metadata in the current document and add the new metadata, keep all but the matching metadata, or add matching metadata to the existing metadata.

- Choose File >File Info (InDesign) or File > Content File Info (InCopy).
- Choose an XMP file from the pop-up menu at the bottom of the dialog box, select an import option, and click OK.
- Choose Import from the pop-up menu at the bottom of the dialog box, select an import option, and click OK. Then double-click the XMP template file you want to import.

Edit metadata in image files

When you generate captions of placed images in InDesign, the metadata from the placed image is used. Although you can edit the metadata of InDesign documents, you cannot edit the metadata of placed files in InDesign. Instead, change the metadata of placed images using their original applications, using Finder or Explorer, or using Adobe Bridge or Adobe Mini Bridge.

1. In InDesign, right-click (Windows) or Control-click (Mac OS) the image, and then choose Edit Original.

You can also choose Edit With and then choose an application such as Adobe Illustrator or Adobe Photoshop.

2. In the original application, choose File > File Info.

3. Edit the metadata, and then click OK.

You can also select an image in Adobe Bridge and choose File > File Info to edit the image metadata. See [Add metadata using the File Info dialog box](#).

Adobe also recommends

- Work with metadata in Adobe

 Twitter™ and Facebook posts are not covered under the terms of Creative Commons.

[Legal Notices](#) | [Online Privacy Policy](#)

PageMaker menu commands

- [PageMaker File menu commands](#)
- [PageMaker Edit menu commands](#)
- [PageMaker Layout menu commands](#)
- [PageMaker Type menu commands](#)
- [PageMaker Element menu commands](#)
- [PageMaker Utilities menu commands](#)
- [PageMaker View menu commands](#)
- [PageMaker Window menu commands](#)

Browse through these tables to learn where Adobe PageMaker commands are found in AdobeInDesign CS5.

[To the top](#)

PageMaker File menu commands

PageMaker command	InDesign equivalent	Additional information
File > New	File > New > Document	
File > Open	File > Open	
File > Recent Publications	File > Open Recent (Windows®)	
File > Close	File > Close	
File > Save	File > Save	There is no preference in InDesign to Save Smaller or Save Faster. Use Save to perform a fast save and Save Asto compact a document to the smallest possible size.
File > Save As	File > Save As	See note above.
File > Revert	File > Revert	InDesign does not revert to "mini-saved" versions of a document as PageMaker does; instead, InDesign offers unlimited levels of Undo.
File > Place	File > Place	
File > Acquire	No equivalent	Scan images using the software that came with your scanner, and then place the images in InDesign.
File > Export	File > Export	
File > Links Manager	Window > Links	
File > Document Setup	File > Document Setup	
File > Printer Styles	File > Print Presets	
File > Print	File > Print	

File > Preferences > General	Edit > Preferences (Windows) or InDesign > Preferences (Mac OS)	Equivalent settings can be found in Composition, Units & Increments, Guides & Pasteboard, and Display Performance preferences.
File > Preferences > Online	No equivalent	You can drag objects from a web browser to InDesign without configuring a proxy.
File > Preferences > Layout Adjustment	Layout > Layout Adjustment	You specify layout adjustment options and enable layout adjustment at the same time. Settings in InDesign match those in PageMaker almost exactly. Ruler guides follow their associated column or margin guides by default. To change this, deselect Allow Ruler Guides To Move.
File > Preferences > Trapping	Window > Output > Trap Presets	To specify trapping preferences, create a new Trap preset.
File > Exit (Windows) or File > Quit (Mac OS)	File > Exit (Windows) or InDesign > Quit InDesign (Mac OS)	

[To the top](#)

PageMaker Edit menu commands

PageMaker command	InDesign equivalent	Additional information
Edit > Undo	Edit > Undo	InDesign allows unlimited levels of Undo.
Edit > Cut	Edit > Cut	
Edit > Copy	Edit > Copy	
Edit > Paste	Edit > Paste	InDesign does not support OLE; however, you can set similar options in the Links panel.
Edit > Clear	Edit > Clear	
Edit > Select All	Edit > Select All	
Edit > Deselect All	Edit > Deselect All	
Edit > Editions (Mac OS)	No equivalent	InDesign does not support Publish/Subscribe; however, you can set similar options in the Links panel.
Edit > Paste Multiple	Edit > Step And Repeat	
Edit > Paste Special	Edit > Paste Without Formatting	
Edit > Insert Object (Windows)	File > Place	
Edit > Edit Story	Edit > Edit In Story Editor	
Edit > Edit Original	Edit > Edit Original	You can also choose Edit Original in the Links panel menu.

Edit > Show Clipboard (Mac OS)	No equivalent	
Edit > Ruby/Tatechuyoko/Emphasis Marks/Composite Glyphs	Ruby Placement and Spacing, Tate-chu-yoko, and Kanten (for emphasis marks) appear on the Character panel menu. Choose Type > Glyphs to display the Glyphs panel.	
Edit > Vertical Text	Type > Writing Direction > Horizontal or Vertical	You can use the Vertical Type tool in the toolbox.

[To the top](#)

PageMaker Layout menu commands

PageMaker command	InDesign equivalent	Additional information
Layout > Go To Page	Layout > Go To Page	You can also double-click a page icon in the Pages panel to jump to that page.
Layout > Insert Pages	Layout > Pages > Insert Pages	
Layout > Remove Pages	Layout > Pages > Delete Pages	
Layout > Sort Pages	Window > Pages	Click and drag pages in the Pages panel to sort them.
Layout > Go Back	Layout > Go Back	
Layout > Go Forward	Layout > Go Forward	
Layout > Column Guides	Layout > Margins And Columns	
Layout > Copy Master Guides	No equivalent	InDesign master guides from any given master are always copied to pages that use that master.
Layout > Autoflow	Press Shift when a loaded text icon  is displayed.	You can flow text manually, automatically (with autoflow), or semi-automatically.

[To the top](#)

PageMaker Type menu commands

PageMaker command	InDesign equivalent	Additional information
Type > Font	Type > Font	
Type > Size	Type > Size	
Type > Leading	Type > Character or Control panel in Character mode (Window > Control)	InDesign uses baseline leading by default, as opposed to proportional leading, which is PageMaker's default.
Type > Type Style	Type > Character or Control panel in	InDesign displays the type styles

	Character mode (Window > Control)	available for the selected font. You can also use Quick Apply.
Type > Expert Kerning	Type > Character or Control panel in Character mode (Window > Control)	Expert kerning in PageMaker is similar to optical kerning in InDesign.
Type > Horizontal Scale	Control panel in Character mode (Window > Control)	
Type > Character	Type > Character	
Type > Paragraph	Type > Paragraph	
Type > Indents/Tabs	Type > Tabs	
Type > Hyphenation	Type > Paragraph	Choose Hyphenation from the Paragraph panel menu.
Type > Alignment	Type > Paragraph or Control panel in Paragraph mode (Window > Control)	
Type > Style	Type > Paragraph Styles or Type > Character Styles	InDesign supports both paragraph and character styles.
Type > Define Styles	Type > Paragraph Styles or Type > Character Styles	Choose New Paragraph Style in the Paragraph Styles panel to create a paragraph style. Choose New Character Style in the Character Styles panel to create a character style.

[To the top](#)

PageMaker Element menu commands



PageMaker command	InDesign equivalent	Additional information
Element > Fill	Window > Color > Swatches or Window > Color > Color	InDesign does not support patterned fills. The Swatches panel in InDesign is equivalent to the Colors palette in PageMaker.
Element > Stroke	Window > Stroke	Choose a stroke style in the Stroke panel or define a custom stroke style.
Element > Fill And Stroke	Window > Color > Swatches, Window > Stroke, and Window > Output > Attributes	Create tints using the Swatches panel. Specify overprinting in the Attributes panel.
Element > Frame > Attach Content	No equivalent	InDesign automatically creates a frame for text files or graphics you import. To paste content into an existing frame, select the frame, and then place or paste the content into it.
Element > Frame > Frame Options	Object > Text Frame Options (text frames only) or Object > Fitting	For text frames, specify columns, vertical alignment, and inset spacing in the Text Frame Options dialog box. Set horizontal alignment in the Paragraph panel (Type > Paragraph). For graphics and text frames, use

		subcommands on the Object > Fitting menu to fit content to a frame (or vice versa).
Element > Frame > Change To Frame	Object > Content > [content type]	
Element > Frame > Next Frame	View > Extras > Show Text Threads	
Element > Frame > Previous Frame	View > Extras > Show Text Threads	
Element > Frame > Remove From Threads	Double-click the in port or out port to break a thread.	
Element > Frame > Delete Content	Select content in the frame, and then press Delete.	Select text with the Type tool. Select graphics with the Direct Selection tool.
Element > Arrange	Object > Arrange	
Element > Align Objects (Windows) or Element > Align (Mac OS)	Window > Object & Layout > Align	
Element > Text Wrap	Window > Text Wrap	
Element > Group	Object > Group	
Element > Ungroup	Object > Ungroup	
Element > Lock Position	Object > Lock Position	
Element > Unlock	Object > Unlock Position	
Element > Mask	Object > Clipping Path	You can also mask a graphic by creating the masking shape, copying the image you want to mask, and then pasting it into the shape (Edit > Paste Into), or by adjusting its graphics frame.
Element > Unmask	Object > Clipping Path	See note above.
Element > Image > Image Control	No equivalent	Use the Edit Original command to change image control settings in the original application.
Element > Image > CMS Source	Object > Image Color Settings	
Element > Image > Photoshop Effects	Object > Effects	
Element > Polygon Settings	Double-click the Polygon tool in the Toolbox	
Element > Rounded Corners	Object > Corner Options	
Element > Link Info	Window > Links	Choose Link Information on the Links panel menu.
Element > Link Options	Type Preferences or Window > Links	In File Handling Preferences, select or deselect Create Links When Placing Text And Spreadsheet Files. Or, on the Links panel menu, choose Unlink.
Element > Non-Printing	Window > Output > Attributes	
Element > Remove Transformation	No equivalent	

PageMaker Utilities menu commands

PageMaker command	InDesign equivalent	Additional information
Utilities > Plug-ins	Help > Configure Plug-ins (Windows) or InDesign > Configure Plug-ins (Mac OS)	
Utilities > Find	Edit > Find/Change	You can perform Find/Change operations in Layout view or Story Editor.
Utilities > Find Next	Edit > Find Next	See note above.
Utilities > Change	Edit > Find/Change	See note above.
Utilities > Spelling	Edit > Spelling > Check Spelling	You can check spelling in Layout view or Story Editor.
Utilities > Book	File > New > Book	You add, delete, and sort documents in a book using the Book panel.
Utilities > Index Entry	Window > Type & Tables > Index	To add an index entry, click the New button in the Index panel.
Utilities > Show Index	Index panel in Reference mode (Window > Type & Tables > Index)	
Utilities > Create Index	Window > Type & Tables > Index	Choose Generate Index on the Index panel menu.
Utilities > Create TOC	Layout > Table Of Contents	
Utilities > Define Colors	Window > Color > Swatches	Choose New Color Swatch in the Swatches panel menu.

PageMaker View menu commands

PageMaker command	InDesign equivalent	Additional information
View > Display Master Items	Choose Hide/Show Master Items from the Pages panel menu	
View > Display Non-Printing Items	Select Normal View Mode  in the Toolbox to view nonprinting items. To hide nonprinting items, select Preview Mode  .	You can also create a layer for objects you do not want to print, and then show or hide that layer when you print or export.
View > Zoom In	View > Zoom In	
View > Zoom Out	View > Zoom Out	
View > Actual Size	View > Actual Size	

View > Fit In Window	View > Fit Page In Window or View > Fit Spread In Window	
View > Entire Pasteboard	View > Entire Pasteboard	
View > Zoom To	Choose a magnification level from the Zoom menu at the bottom of the document window.	
View > Hide/Show Rulers	View > Hide/Show Rulers	
View > Snap To Rulers	No equivalent	
View > Zero Lock	Right-click (Windows) or Control-click (Mac OS) the zero point, and then choose Lock Zero Point from the context menu that appears.	
View > Hide/Show Guides	View > Grids & Guides > Hide/Show Guides	
View > Snap To Guides	View > Grids & Guides > Snap To Guides	
View > Lock Guides	View > Grids & Guides > Lock Guides And View > Grids & Guides > Lock Column Guides	
View > Clear Ruler Guides	Using InDesign keyboard shortcuts, Press Ctrl+Alt+G (Windows) or Command+Option+G (Mac OS) to select all guides on the current spread, and then press Delete.	
View > Send Guides To Back	Edit > Preferences > Guides & Pasteboard (Windows) or InDesign > Preferences > Guides & Pasteboard (Mac OS)	Select the Guides In Back option.
View > Hide/Show Scroll Bars	No equivalent	

[To the top](#)

PageMaker Window menu commands

PageMaker command	InDesign equivalent	Additional information
Window > Arrange Icons (Windows)	No equivalent	
Window > Tile	Window > Arrange > Tile	
Window > Cascade	Window > Arrange > Cascade	
Window > Hide/Show Tools	Window > Tools	
Window > Hide/Show Control Palette	Window > Control	
Window > Hide/Show Colors	Window > Color > Swatches or Window > Color > Color	
Window > Hide/Show Styles	Window > Styles > Paragraph Styles	

	or Character Styles	
Window > Hide/Show Layers	Window > Layers	
Window > Hide/Show Master Pages	Window > Pages	
Window > Hide/Show Hyperlinks	Window > Interactive > Hyperlinks	
Window > Plug-in Palettes	No equivalent	Plug-ins appear as added options in InDesign menus or panels, or in InDesign dialog boxes.
Window > <i>[name of open document]</i>	Window > <i>[name of open document]</i>	

 Twitter™ and Facebook posts are not covered under the terms of Creative Commons.

[Legal Notices](#) | [Online Privacy Policy](#)

Default keyboard shortcuts

[Interactive Shortcuts Guide](#)

- [Keys for tools](#)
- [Keys for selecting and moving objects](#)
- [Keys for transforming objects](#)
- [Keys for editing paths and frames](#)
- [Keys for tables](#)
- [Keys for finding and changing text](#)
- [Keys for working with type](#)
- [Keys for navigating through and selecting text](#)
- [Keys for viewing documents and document workspaces](#)
- [Keys for working with XML](#)
- [Keys for indexing](#)
- [Keys for panels](#)
- [Keys for the Control panel](#)
- [Keys for type panels and dialog boxes](#)
- [Keys for the character and paragraph styles](#)
- [Keys for the Tabs panel](#)
- [Keys for the Layers panel](#)
- [Keys for the Pages panel](#)
- [Keys for the Color panel](#)
- [Keys for using the Separations Preview panel](#)
- [Keys for the Swatches panel](#)
- [Keys for the Transform panel](#)
- [Keys for resolving conflicts between Mac OS 10.3x and 10.4](#)

Adobe InDesign CS5 provides shortcuts to help you quickly work in documents without using the mouse. Many keyboard shortcuts appear next to the command names in menus. You can use the default InDesign shortcut set, the QuarkXPress 4.0 or Adobe PageMaker 7.0 shortcut set, or a shortcut set that you create. You can share shortcut sets with others using InDesign on the same platform.

InDesign provides shortcuts to help you quickly work in documents without using the mouse. Many keyboard shortcuts appear next to the command names in menus. You can use the default InDesign shortcut set or a shortcut set that you create. You can share shortcut sets with others using InDesign on the same platform.

[To the top](#)

Interactive Shortcuts Guide



An interactive Shortcuts guide that lets you find shortcuts easily. View online or download as an AIR application.... [Read More](#)

<http://goo.gl/80wvo>



by [Marijan Tompa](#)
<http://tomaxxi.com/>

[Contribute your expertise to Adobe Community Help](#)

[To the top](#)

Keys for tools

 You can generate a list of the current keyboard set by choosing *Show Set* in the *Keyboard Shortcuts* dialog box. This option is especially useful for printing a copy of your custom shortcuts.

This table isn't a complete list of keyboard shortcuts. It lists only those shortcuts that aren't displayed in menu commands or tool tips.

 Choose *Window > Utilities > Tool Hints*, and then select a tool to view its shortcuts and modifier keys.

Tool	Windows	Mac OS
Selection tool	V, Esc	V, Esc
Direct Selection tool	A	A
Toggle Selection and Direct Selection tool	Ctrl+Tab	Command+Control+Tab
Page tool	Shift+P	Shift+P
Gap tool	U	U
Pen tool	P	P
Add Anchor Point tool	=	=
Add Anchor Point tool	=	= (on the numeric pad)
Delete Anchor Point tool	-	-
Delete Anchor Point tool		-
Convert Direction Point tool	Shift+C	Shift+C
Type tool	T	T
Type On A Path tool	Shift+T	Shift+T
Pencil tool (Note tool)	N	N
Line tool	\	\
Rectangle Frame tool	F	F
Rectangle tool	M	M
Ellipse tool	L	L
Rotate tool	R	R
Scale tool	S	S
Shear tool	O	O
Free Transform tool	E	E
Eyedropper tool	I	I
Measure tool	K	K
Gradient tool	G	G
Scissors tool	C	C
Hand tool	H	H
Temporarily selects Hand tool	Spacebar (Layout mode), Alt (Text mode), or Alt+Spacebar (both)	Spacebar (Layout mode), Option (Text mode), or Option+Spacebar (both)

Zoom tool	Z	Z
Temporarily selects Zoom In tool	Ctrl+Spacebar	Command+Spacebar
Toggle Fill and Stroke	X	X
Swap Fill and Stroke	Shift+X	Shift+X
Toggle between Formatting Affects Container and Formatting Affects Text	J	J
Apply Color	, [comma]	, [comma]
Apply Gradient	. [period]	. [period]
Apply No Color	/	/
Switch between Normal View and Preview Mode	W	W
Frame Grid tool (horizontal)	Y	Y
Frame Grid tool (vertical)	Q	Q
Gradient Feather tool	Shift+G	Shift+G

[To the top](#)

Keys for selecting and moving objects

This table isn't a complete list of keyboard shortcuts. It lists only those shortcuts that aren't displayed in menu commands or tool tips.

Result	Windows	Mac OS
Temporarily select Selection or Direct Selection tool (last used)	Any tool (except selection tools)+Ctrl	Any tool (except selection tools)+Command
Temporarily select Group Selection tool	Direct Selection tool+Alt; or Pen, Add Anchor Point, or Delete Anchor Point tool+Alt+Ctrl	Direct Selection tool+Option; or Pen, Add Anchor Point, or Delete Anchor Point tool+Option+Command
Select container of selected content	Esc or double-click	Esc or double-click
Select content of selected container	Shift+Esc or double-click	Shift+Esc or double-click
Add to or subtract from a selection of multiple objects	Selection, Direct Selection, or Group Selection tool+Shift-click (to deselect, click center point)	Selection, Direct Selection, or Group Selection tool+Shift-click (to deselect, click center point)
Duplicate selection	Selection, Direct Selection, or Group Selection tool+Alt-drag*	Selection, Direct Selection, or Group Selection tool+ Option-drag*
Duplicate and offset selection	Alt+Left Arrow, Right Arrow, Up Arrow, or Down Arrow key	Option+Left Arrow, Right Arrow, Up Arrow, or Down Arrow key
Duplicate and offset selection by 10 times**	Alt+Shift+Left Arrow, Right Arrow, Up Arrow, Down Arrow key	Option+Shift+Left Arrow, Right Arrow, Up Arrow, Down Arrow key
Move selection**	Left Arrow, Right Arrow, Up Arrow, Down Arrow key	Left Arrow, Right Arrow, Up Arrow, Down Arrow key

Move selection by 10th**	Ctrl+Shift+Left Arrow, Right Arrow, Up Arrow, Down arrow key	Command+Shift+Left Arrow, Right Arrow, Up Arrow, Down arrow key
Move selection by 10 times**	Shift+Left Arrow, Right Arrow, Up Arrow, Down Arrow key	Shift+Left Arrow, Right Arrow, Up Arrow, Down Arrow key
Select master page item from document page	Selection or Direct Selection tool+Ctrl+Shift-click	Selection or Direct Selection tool+Command+Shift-click
Select next object behind or in front	Selection tool+Ctrl-click, or Selection tool+Alt+Ctrl-click	Selection tool+Command-click or Selection tool+Option+ Command-click
Select next or previous frame in story	Alt+Ctrl+Page Down/ Alt+Ctrl+Page Up	Option+Command+Page Down/ Option+Command+Page Up
Select first or last frame in story	Shift+Alt+Ctrl+Page Down/ Shift+Alt+Ctrl+Page Up	Shift+Option+Command+Page Down/ Shift+Option+Command+Page Up
*Press Shift to constrain movement to 45° angles.		
**Amount is set in Edit > Preferences > Units & Increments (Windows) or InDesign > Preferences > Units & Increments (Mac OS).		

[To the top](#)

Keys for transforming objects

This table isn't a complete list of keyboard shortcuts. It lists only those shortcuts that aren't displayed in menu commands or tool tips.

Result	Windows	Mac OS
Duplicate and transform selection	Transformation tool+Alt-drag*	Transformation tool+Option-drag*
Display Transform tool dialog box	Select object+double-click Scale tool, Rotate tool, or Shear tool in Toolbox	Select object+double-click Scale tool, Rotate tool, or Shear tool in Toolbox
Decrease scale by 1%	Ctrl+,	Command+,
Decrease scale by 5%	Ctrl+Alt+,	Command+Option+,
Increase scale by 1%	Ctrl+.	Command+.
Increase scale by 5%	Ctrl+Alt+.	Command+Option+.
Resize frame and content	Selection tool+Ctrl-drag	Selection tool+Command-drag
Resize frame and content proportionately	Selection tool+Shift+Ctrl-drag	Selection tool+Shift+Command-drag
Constrain proportion	Ellipse tool, Polygon tool, or Rectangle tool+Shift-drag	Ellipse tool, Polygon tool, or Rectangle tool+Shift-drag
Switch image from High Quality Display to Fast Display	Ctrl+Alt+Shift+Z	Command+Option+Shift+Z
*After you select a transformation tool, hold down the mouse button, and then hold down Alt (Windows) or Option (Mac OS) and drag. Press Shift to constrain movement to 45° angles.		

[To the top](#)

Keys for editing paths and frames

This table isn't a complete list of keyboard shortcuts. It lists only those shortcuts that aren't displayed in menu commands or tool tips.

Result	Windows	Mac OS
Temporarily select Convert Direction Point tool	Direct Selection tool+Alt+Ctrl, or Pen tool+Alt	Direct Selection tool+Option+Command, or Pen tool+Option
Temporarily switch between Add Anchor Point and Delete Anchor Point tool	Alt	Option
Temporarily select Add Anchor Point tool	Scissors tool+Alt	Scissors tool+Option
Keep Pen tool selected when pointer is over path or anchor point	Pen tool+Shift	Pen tool+Shift
Move anchor point and handles while drawing	Pen tool+spacebar	Pen tool+spacebar
Display the Stroke panel	F10	Command+F10

[To the top](#)

Keys for tables

This table isn't a complete list of keyboard shortcuts. It lists only those shortcuts that aren't displayed in menu commands or tool tips.

Result	Windows	Mac OS
Insert or delete rows or columns while dragging	Begin dragging row or column border, and then hold down Alt as you drag	Begin dragging row or column border, and then hold down Option as you drag
Resize rows or columns without changing the size of the table	Shift–drag interior row or column border	Shift–drag interior row or column border
Resize rows or columns proportionally	Shift–drag right or bottom table border	Shift–drag right or bottom table border
Move to next/previous cell	Tab/Shift+Tab	Tab/Shift+Tab
Move to first/last cell in column	Alt+Page Up/ Alt+Page Down	Option+Page Up/ Option+Page Down
Move to first/last cell in row	Alt+Home/ Alt+End	Option+Home/ Option+End
Move to first/last row in frame	Page Up/Page Down	Page Up/Page Down
Move up/down one cell	Up Arrow/Down Arrow	Up Arrow/Down Arrow
Move left/right one cell	Left Arrow/Right Arrow	Left Arrow/Right Arrow
Select cell above/below the current cell	Shift+Up Arrow/ Shift+Down Arrow	Shift+Up Arrow/ Shift+Down Arrow
Select cell to the right/left of the	Shift+Right Arrow/ Shift+Left Arrow	Shift+Right Arrow/ Shift+Left Arrow

current cell		
Start row on next column	Enter (numeric keypad)	Enter (numeric keypad)
Start row on next frame	Shift+Enter (numeric keypad)	Shift+Enter (numeric keypad)
Toggle between text selection and cell selection	Esc	Esc

[To the top](#)

Keys for finding and changing text

This table isn't a complete list of keyboard shortcuts. It lists only those shortcuts that aren't displayed in menu commands or tool tips.

Result	Windows	Mac OS
Insert selected text into Find What box	Ctrl+F1	Command+F1
Insert selected text into Find What box and finds next	Shift+F1	Shift+F1
Find next occurrence of Find What text	Shift+F2 or Alt+Ctrl+F	Shift+F2 or Option+Command+F
Insert selected text into Change To box	Ctrl+F2	Command+F2
Replace selection with Change To text	Ctrl+F3	Command+F3

[To the top](#)

Keys for working with type

This table isn't a complete list of keyboard shortcuts. It lists only those shortcuts that aren't displayed in menu commands or tool tips.

Result	Windows	Mac OS
Bold (only for fonts with bold face)	Shift+Ctrl+B	Shift+Command+B
Italic (only for fonts with italic face)	Shift+Ctrl+I	Shift+Command+I
Normal	Shift+Ctrl+Y	Shift+Command+Y
Underline	Shift+Ctrl+U	Shift+Command+U
Strikethrough	Shift+Ctrl+/ /	Control+Shift+Command+/ /
All caps (on/off)	Shift+Ctrl+K	Shift+Command+K
Asian language hyphenation	Shift+Ctrl+K	Shift+Command+K
Small caps (on/off)	Shift+Ctrl+H	Shift+Command+H
Tate-chu-yoko setting	Shift+Ctrl+H	Shift+Command+H

Superscript	Shift+Ctrl+(+) [plus sign]	Shift+Command+(+) [plus sign]
Subscript	Shift+Alt+Ctrl+(+) [plus sign]	Shift+Option+Command+(+) [plus sign]
Reset horizontal or vertical scale to 100%	Shift+Ctrl+X or Shift+Alt+Ctrl+X	Shift+Command+X or Shift+Option+Command+X
Basic letter group setting or detail setting	Shift+Ctrl+X or Shift+Alt+Ctrl+X	Shift+Command+X or Shift+Option+Command+X
Align left, right, or center	Shift+Ctrl+L, R, or C	Shift+Command+L, R, or C
Justify all lines	Shift+Ctrl+F (all lines) or J (all but last line)	Shift+Command+F (all lines) or J (all but last line)
Align both ends or equal spacing	Shift+Ctrl+F (align both end) or J (equal spacing)	Shift+Command+F (align both ends) or J (equal spacing)
Increase or decrease point size*	Shift+Ctrl+> or <	Shift+Command+> or <
Increase or decrease point size by five times*	Shift+Ctrl+Alt+> or <	Shift+Command+ Option+> or <
Increase or decrease leading (horizontal text)*	Alt+Up Arrow/ Alt+Down Arrow	Option+Up Arrow/ Option+Down Arrow
Increase or decrease leading (vertical text)*	Alt+Right Arrow/ Alt+Left Arrow	Option+Right Arrow/ Option+Left Arrow
Increase or decrease leading by five times (horizontal text)*	Alt+Ctrl+Up Arrow/ Alt+Ctrl+Down Arrow	Option+Command+Up Arrow/ Option+Command+Down Arrow
Increase or decrease leading by five times (vertical text)*	Alt+Ctrl+Right Arrow/ Alt+Ctrl+Left Arrow	Option+Command+Right Arrow/ Option+Command+Left Arrow
Auto leading	Shift+Alt+Ctrl+A	Shift+Option+Command+A
Align to grid (on/off)	Shift+Alt+Ctrl+G	Shift+Option+Command+G
Auto-hyphenate (on/off)	Shift+Alt+Ctrl+H	Shift+Option+Command+H
Increase or decrease kerning and tracking (horizontal text)	Alt+Left Arrow/Alt+Right Arrow	Option+Left Arrow/ Option+Right Arrow
Increase or decrease kerning and tracking (vertical text)	Alt+Up Arrow/ Alt+Down Arrow	Option+Up Arrow/ Option+Down Arrow
Increase or decrease kerning and tracking by five times (horizontal text)	Alt+Ctrl+Left Arrow/ Alt+Ctrl+Right Arrow	Option+Command+Left Arrow/ Option+Command+Right Arrow
Increase or decrease kerning and tracking by five times (vertical text)	Alt+Ctrl+Up Arrow/ Alt+Ctrl+Down Arrow	Option+Command+Up Arrow/ Option+Command+Down Arrow
Increase kerning between words*	Alt+Ctrl+\	Option+Command+\
Decrease kerning between words*	Alt+Ctrl+Backspace	Option+Command+Delete
Clear all manual kerning and reset tracking to 0	Alt+Ctrl+Q	Option+Command+Q
Increase or decrease baseline shift** (horizontal text)	Shift+Alt+Up Arrow/ Shift+Alt+Down Arrow	Shift+Option+Up Arrow/ Shift+Option+Down Arrow
Increase or decrease baseline shift** (vertical text)	Shift+Alt+Right Arrow/ Shift+Alt+Left Arrow	Shift+Option+Right Arrow/ Shift+Option+Left Arrow

Increase or decrease baseline shift by five times (horizontal text)	Shift+Alt+Ctrl+Up Arrow/ Shift+Alt+Ctrl+Down Arrow	Shift+Option+Command+Up Arrow/ Shift+Option+Command+Down Arrow
Increase or decrease baseline shift by five times (vertical text)	Shift+Alt+Ctrl+Right Arrow/ Shift+Alt+Ctrl+Left Arrow	Shift+Option+Command+Right Arrow/ Shift+Option+Command+Left Arrow
Automatically flow story	Shift-click loaded text icon	Shift-click loaded text icon
Semi-automatically flow story	Alt-click loaded text icon	Option-click loaded text icon
Recompose all stories	Alt+Ctrl+/ 	Option+Command+/
Insert current page number	Alt+Ctrl+N	Option+Command+N
*Press Shift to increase or decrease kerning between words by five times.		
**Amount is set in Edit > Preferences > Units & Increments (Windows) or InDesign > Preferences > Units & Increments (Mac OS).		

[To the top](#)

Keys for navigating through and selecting text

This table isn't a complete list of keyboard shortcuts. It lists only those shortcuts that aren't displayed in menu commands or tool tips.

Result	Windows Action	Mac OS Action
Move to right or left one character	Right Arrow/ Left Arrow	Right Arrow/ Left Arrow
Move up or down one line	Up Arrow/ Down Arrow	Up Arrow/ Down Arrow
Move to right or left one word	Ctrl+Right Arrow/ Ctrl+Left Arrow	Command+Right Arrow/ Command+Left Arrow
Move to start or end of line	Home/End	Home/End
Move to previous or next paragraph	Ctrl+Up Arrow/ Ctrl+Down Arrow	Command+Up Arrow/ Command+Down Arrow
Move to start or end of story	Ctrl+Home/ Ctrl+End	Command+Home/ Command+End
Select one word	Double-click word	Double-click word
Select one character right or left	Shift+Right Arrow/ Shift+Left Arrow	Shift+Right Arrow/ Shift+Left Arrow
Select one line above or below	Shift+Up Arrow/ Shift+Down Arrow	Shift+Up Arrow/ Shift+Down Arrow
Select start or end of line	Shift+Home/ Shift+End	Shift+Home/ Shift+End
Select one paragraph	Triple-click or quadruple-click paragraph, depending on Text Preferences setting	Triple-click or quadruple-click paragraph, depending on Text Preferences setting
Select one paragraph before or after	Shift+Ctrl+Up Arrow/ Shift+Ctrl+Down Arrow	Shift+Command+Up Arrow/ Shift+Command+Down Arrow
Select current line	Shift+Ctrl+\	Shift+Command+\
Select characters from insertion point	Shift-click	Shift-click
Select start or end of story	Shift+Ctrl+Home/ Shift+Ctrl+End	Shift+Command+Home/ Shift+Command+End

Select all in story	Ctrl+A	Command+A
Select first/last frame	Shift+Alt+Ctrl+Page Up/ Shift+Alt+Ctrl+Page Down	Shift+Option+ Command+Page Up/ Shift+Option+ Command+Page Down
Select previous/next frame	Alt+Ctrl+Page Up/ Alt+Ctrl+Page Down	Option+Command+Page Up/ Option+Command+Page Down
Delete word in front of insertion point (Story Editor)	Ctrl+Backspace or Delete	Command+Delete or Del (numeric keypad)
Update missing font list	Ctrl+Alt+Shift+/ 	Command+Option+Shift+/

[To the top](#)

Keys for viewing documents and document workspaces

This table isn't a complete list of keyboard shortcuts. It lists only those shortcuts that aren't displayed in menu commands or tool tips.

Result	Windows	Mac OS
Temporarily select Hand tool	Spacebar (with no text insertion point), Alt-drag (with text insertion point), or Alt+spacebar (in both text and non- text modes)	Spacebar (with no text insertion point), Option-drag (with text insertion point), or Option+spacebar (in both text and nontext modes)
Temporarily select Zoom In tool	Ctrl+spacebar	Command+spacebar
Temporarily select Zoom Out tool	Alt+Ctrl+spacebar or Alt+Zoom In tool	Option+Command+spacebar or Option+Zoom Intool
Zoom to 50%, 200%, or 400%	Ctrl+5, 2, or 4	Command+5, 2, or 4
Redraw screen	Shift+F5	Shift+F5
Open new default document	Ctrl+Alt+N	Command+Option+N
Switch between current and previous zoom levels	Alt+Ctrl+2	Option+Command+2
Switch to next/previous document window	Ctrl+~ [tilde]/ Shift+Ctrl+F6 or Ctrl+Shift+~ [tilde]	Command+F6 or Command+~ [tilde]/ Command+Shift+~ [tilde]
Scroll up/down one screen	Page Up/Page Down	Page Up/Page Down
Go back/forward to last-viewed page	Ctrl+Page Up/ Ctrl+Page Down	Command+Page Up/ Command+Page Down
Go to previous/next spread	Alt+Page Up/ Alt+Page Down	Option+Page Up/ Option+Page Down
Fit spread in window	Double-click Hand tool	Double-click Hand tool
Activate the Go To command	Ctrl+J	Command+J
Fit selection in window	Ctrl+Alt+(+) [plus sign]	Command+Option+(+) [plus sign]
Display the entire object	Ctrl+Alt+(+) [plus sign]	Command+Option+(+) [plus sign]
Go to master page while \ panel is closed	Ctrl+J, type prefix of master, press Enter	Command+J, type prefix of master, press Return

Cycle through units of measurement	Shift+Alt+Ctrl+U	Shift+Option+Command+U
Snap guide to ruler increments	Shift–drag guide	Shift–drag guide
Switch between page and spread guides (creation only)	Ctrl–drag guide	Command–drag guide
Temporarily turn on/off snap to		Control-drag object
Create vertical and horizontal ruler guides for the spread	Ctrl–drag from zero point	Command–drag from zero point
Select all guides	Alt+Ctrl+G	Option+Command+G
Lock or unlock zero point	Right-click zero point and choose an option	Control–click zero point and choose an option
Use current magnification for view threshold of new guide	Alt–drag guide	Option–drag guide
Select buttons in alert dialog boxes	Press first letter of button name, if underlined	Press first letter of button name
Show information on installed plug-ins and InDesign components	Ctrl+Help > About Design	Command+InDesign menu > About InDesign

[To the top](#)

Keys for working with XML

This table isn't a complete list of keyboard shortcuts. It lists only those shortcuts that aren't displayed in menu commands or tool tips.

Result	Windows	Mac OS
Expand/Collapse element	Right Arrow/Left Arrow	Right Arrow/Left Arrow
Expand/Collapse element and child elements	Alt+Right Arrow/ Alt+Left Arrow	Option+Right Arrow/ Option+Left Arrow
Extend XML selection up/down	Shift+Up Arrow/ Shift+Down Arrow	Shift+Up Arrow/ Shift+Down Arrow
Move XML selection up/down	Up Arrow/ Down Arrow	Up Arrow/ Down Arrow
Scroll structure pane up/down one screen	Page Up/ Page Down	Page Up/ Page Down
Select first/last XML node	Home/ End	Home/ End
Extend selection to first/last XML node	Shift+Home/ Shift+End	Shift+Home/ Shift+End
Go to previous/next validation error	Ctrl+Left Arrow/ Ctrl+Right Arrow	Command+Left Arrow/ Command+Right Arrow
Automatically tag text frames and tables	Ctrl+Alt+Shift+F7	Command+Option+Shift+F7

[To the top](#)

Keys for indexing

This table isn't a complete list of keyboard shortcuts. It lists only those shortcuts that aren't displayed in menu commands or tool tips.

Result	Windows	Mac OS
Create index entry without dialog box (alphanumeric only)	Shift+Ctrl+Alt+[Shift+Command+Option+[
Open index entry dialog box	Ctrl+7	Command+7
Create proper name index entry (last name, first name)	Shift+Ctrl+Alt+]	Shift+Command+Option+]

[To the top](#)

Keys for panels

This table isn't a complete list of keyboard shortcuts. It lists only those shortcuts that aren't displayed in menu commands or tool tips.

Result	Windows	Mac OS
Delete without confirmation	Alt-click Delete icon	Option-click Delete icon
Create item and set options	Alt-click New button	Option-click New button
Apply value and keep focus on option	Shift+Enter	Shift+Enter
Activate last-used option in last-used panel	Ctrl+Alt+~ [tilde]	Command+Option+~ [tilde]
Select range of styles, layers, links, swatches, or library objects in a panel	Shift-click	Shift-click
Select nonadjacent styles, layers, links, swatches, or library objects in a panel	Ctrl-click	Command-click
Apply value and select next value	Tab	Tab
Move focus to selected object, text, or window	Esc	Esc
Show/Hide all panels, Toolbox, and Control panel (with no insertion point)	Tab	Tab
Show/Hide all panels except the Toolbox and Control panel (docked or not)	Shift+Tab	Shift+Tab
Open or close all stashed panels	Ctrl+Alt+Tab	Command+Option+Tab
Stash a panel group	Alt+drag any panel tab (in the group) to edge of screen	Option+drag any panel tab (in the group) to edge of window
Select item by name	Alt+Ctrl-click in list, and then use keyboard to select item by name	Option+Command-click in list and then use keyboard to select item by name

Open the Drop Shadow panel	Alt+Ctrl+M	Command+Option+M
----------------------------	------------	------------------

[To the top](#)

Keys for the Control panel

This table isn't a complete list of keyboard shortcuts. It lists only those shortcuts that aren't displayed in menu commands or tool tips.

Result	Windows	Mac OS
Toggle focus to/from Control panel	Ctrl+6	Command+6
Toggle Character/Paragraph text attributes mode	Ctrl+Alt+7	Command+Option+7
Change reference point when proxy has focus	Any key on the numeric keypad or keyboard numbers	Any key on the numeric keypad or keyboard numbers
Display the pop-up menu that has focus	Alt+Down Arrow	
Open Units & Increments Preferences	Alt-click Kerning icon	Option-click Kerning icon
Open the Text Frame Options dialog box	Alt-click Number Of Columns icon	Option-click Number of Columns icon
Open the Move dialog box	Alt-click X or Y icon	Option-click X or Y icon
Open the Rotate dialog box	Alt-click Angle icon	Option-click Angle icon
Open the Scale dialog box	Alt-click X or Y Scale icon	Option-click X or Y Scale icon
Open the Shear dialog box	Alt-click Shear icon	Option-click Shear icon
Open Text Preferences	Alt-click Superscript, Subscript, or Small Caps button	Option-click Superscript, Subscript, or Small Caps button
Open the Underline Options dialog box	Alt-click Underline button	Option-click Underline button
Open the Strikethrough Options dialog box	Alt-click Strikethrough button	Option-click Strikethrough button
Open the Grids Preferences	Alt-click Align To Baseline Grid, or Do Not Align To Baseline Grid button	Option-click Align To Baseline Grid, or Do Not Align To Baseline Grid button
Open the Drop Caps & Nested Styles dialog box	Alt-click Drop Cap Number Of Lines, or Drop Cap One Or More Characters icon	Option-click Drop Cap Number Of Lines, or Drop Cap One Or More Characters icon
Open the Justification dialog box	Alt-click Leading icon	Option-click Leading icon
Open Named Grid dialog box	Double-click Named Grid icon	Double-click Named Grid icon
Open New Named Grid Options dialog box	Alt-click Named Grid icon	Option-click Named Grid icon
Open Frame Grid Options dialog box	Alt-click Number of characters Horizontal, Number of Characters Vertical, Character Aki, Line Aki,	Option-click Number of characters Horizontal, Number of Characters Vertical, Character Aki, Line Aki,

Vertical Scale, Horizontal Scale, Grid View, Font Size, Number of Columns, or Column Gutter icon

Vertical Scale, Horizontal Scale, Grid View, Font Size, Number of Columns, or Column Gutter icon

[To the top](#)

Keys for type panels and dialog boxes

This table isn't a complete list of keyboard shortcuts. It lists only those shortcuts that aren't displayed in menu commands or tool tips.

Result	Windows	Mac OS
Open Justification dialog box	Alt+Ctrl+Shift+J	Option+Command+Shift+J
Open Paragraph Rules dialog box	Alt+Ctrl+J	Option+Command+J
Open Keep Options dialog box	Alt+Ctrl+K	Option+Command+K
Activate Character panel	Ctrl+T	Command+T
Activate Paragraph panel	Ctrl+Alt+T	Command+Option+T

[To the top](#)

Keys for the character and paragraph styles

This table isn't a complete list of keyboard shortcuts. It lists only those shortcuts that aren't displayed in menu commands or tool tips.

Result	Windows	Mac OS
Make character style definition match text	Select text and press Shift+Alt+Ctrl+C	Select text and press Shift+Option+Command+C
Make paragraph style definition match text	Select text and press Shift+Alt+Ctrl+R	Select text and press Shift+Option+Command+R
Change options without applying style	Shift+Alt+Ctrl-double-click style	Shift+Option+Command-double-click style
Remove style and local formatting	Alt-click paragraph style name	Option-click paragraph style name
Clear overrides from paragraph style	Alt+Shift-click paragraph style name	Option+Shift-click paragraph style name
Show/hide Paragraph and Character Styles panels, respectively	F11, Shift+F11	Command+F11, Command+Shift+F11

[To the top](#)

Keys for the Tabs panel

This table isn't a complete list of keyboard shortcuts. It lists only those shortcuts that aren't displayed in menu commands or tool tips.

Result	Windows	Mac OS
Activate Tabs panel	Shift+Ctrl+T	Shift+Command+T
Switch between alignment options	Alt-click tab	Option-click tab

[To the top](#)

Keys for the Layers panel

This table isn't a complete list of keyboard shortcuts. It lists only those shortcuts that aren't displayed in menu commands or tool tips.

Result	Windows	Mac OS
Select all objects on layer	Alt-click layer	Option-click layer
Copy selection to new layer	Alt-drag small square to new layer	Option-drag small square to new layer
Add new layer below selected layer	Ctrl-click Create New Layer	Command-click Create New Layer
Add new layer to the top of the layer list	Shift+Ctrl-click Create New Layer	Shift+Command-click Create New Layer
Add new layer to the top of the layer list and open New Layer dialog box	Shift+Alt+Ctrl-click Create New Layer	Cmd+Option+Shift-click Create New Layer
Add new layer and open New Layer dialog box	Alt-click Create New Layer	Option-click Create New Layer

[To the top](#)

Keys for the Pages panel

This table isn't a complete list of keyboard shortcuts. It lists only those shortcuts that aren't displayed in menu commands or tool tips.

Result	Windows	Mac OS
Apply master to selected page	Alt-click master	Option-click master
Base another master page on selected master	Alt-click the master you want to base the selected master on	Option-click the master you want to base the selected master on
Create master page	Ctrl-click Create New Page button	Command-click Create New Page button
Display Insert Pages dialog box	Alt-click New Page button	Option-click New Page button
Add new page after last page	Shift+Ctrl+P	Shift+Command+P

[To the top](#)

Keys for the Color panel

This table isn't a complete list of keyboard shortcuts. It lists only those shortcuts that aren't displayed in menu commands or tool tips.

Result	Windows	Mac OS
Move color sliders in tandem	Shift-drag slider	Shift-drag slider
Select a color for the nonactive fill or stroke	Alt-click color bar	Option-click color bar
Switch between color modes (CMYK, RGB, LAB)	Shift-click color bar	Shift-click color bar

[To the top](#)

Keys for using the Separations Preview panel

This table isn't a complete list of keyboard shortcuts. It lists only those shortcuts that aren't displayed in menu commands or tool tips.

Result	Windows Action	Mac OS Action
Turn on Overprint preview	Ctrl+Alt+Shift+Y	Command+Option+Shift+Y
Show all plates	Ctrl+Alt+Shift+~ [tilde]	Command+Option+Shift+~ [tilde]
Show Cyan plate	Ctrl+Alt+Shift+1	Command+Option+Shift+1
Show Magenta plate	Ctrl+Alt+Shift+2	Command+Option+Shift+2
Show Yellow plate	Ctrl+Alt+Shift+3	Command+Option+Shift+3
Show Black plate	Ctrl+Alt+Shift+4	Command+Option+Shift+4
Show 1st Spot plate	Ctrl+Alt+Shift+5	Command+Option+Shift+5
Show 2nd Spot plate	Ctrl+Alt+Shift+6	Command+Option+Shift+6
Show 3rd Spot plate	Ctrl+Alt+Shift+7	Command+Option+Shift+7

[To the top](#)

Keys for the Swatches panel

This table isn't a complete list of keyboard shortcuts. It lists only those shortcuts that aren't displayed in menu commands or tool tips.

Result	Windows	Mac OS
Create new swatch based on the current swatch	Alt-click New Swatch button	Option-click New Swatch button
Create spot color swatch based on the current swatch	Alt+Ctrl-click New Swatch button	Option+Command-click New Swatch button

Change options without applying swatch	Shift+Alt+Ctrl-double-click swatch	Shift+Option+Command-double-click swatch
--	------------------------------------	--

[To the top](#)

Keys for the Transform panel

This table isn't a complete list of keyboard shortcuts. It lists only those shortcuts that aren't displayed in menu commands or tool tips.

Result	Windows	Mac OS
Apply value and copy object	Alt+Enter	Option+Enter
Apply width, height, or scale value proportionally	Ctrl+Enter	Command+Enter

[To the top](#)

Keys for resolving conflicts between Mac OS 10.3x and 10.4

This table isn't a complete list of keyboard shortcuts. It lists only those shortcuts that aren't displayed in menu commands or tool tips.

Result	Mac OS
Open Preferences dialog box	Command+K
Open Paragraph Styles panel	Command+F11
Open Character Styles panel	Command+Shift+F11
Open Swatches panel	F5
Open Pages panel	Command+F12
Minimize active application window	Command+M
Hide application	Command+H

- [Use keyboard shortcut sets](#)

 Twitter™ and Facebook posts are not covered under the terms of Creative Commons.

[Legal Notices](#) | [Online Privacy Policy](#)

Converting QuarkXPress and PageMaker documents

[Open QuarkXPress files in InDesign](#)
[Convert PageMaker documents](#)

[To the top](#)

Open QuarkXPress files in InDesign

InDesign can convert document and template files from QuarkXPress 3.3 or 4.1x. InDesign can also convert document and template files from multi-language QuarkXPress Passport 4.1x files, so there is no longer any need to save these files as single-language files first. (To convert documents created with QuarkXPress 5.0 or later, reopen the documents in QuarkXPress and save them in 4.0 format.)

For more information, see the QuarkXPress Conversion Guide (PDF) at www.adobe.com/go/learn_quarkconv.

Open a QuarkXPress document or template

1. Make sure that the original application file is closed.
2. To ensure that all links are maintained, copy all linked files to the same QuarkXPress document folder.
3. In InDesign, choose File > Open.
4. In Windows, choose QuarkXPress (3.3-4.1x) or QuarkXPress Passport (4.1x) from the Files Of Type menu.
5. Select a file and click Open.

Note: If InDesign cannot convert a file or a specific part of a file, it displays a warning describing the reasons it cannot convert it and the results of the conversion.

6. If a warning dialog box appears, do one of the following:
 - Click Save to save a copy of the warnings as a text file, and then open the file in InDesign.
 - Click Close to close the dialog box and open the file in InDesign.
7. To more accurately convert text wrap applied in QuarkXPress, do the following in InDesign:
 - Select Text Wrap Only Affects Objects Beneath in the Composition area of the Preferences dialog box.
 - Assign the Adobe Single-Line Composer in the Paragraph panel menu to one or more paragraphs.

 If you're experiencing problems with the converted QuarkXPress document, use the Export dialog box to save the document in InDesign Markup (IDML) format. Then open the IDML file and save it as an InDesign document.

Save a QuarkXPress template as an InDesign template

1. Open the template in InDesign.

2. Choose File > Save As and specify a location and filename.
3. Choose InDesign Template for Save As Type (Windows) or Format (Mac OS), and then click Save.

What gets converted from QuarkXPress

When you open a QuarkXPress file, InDesign converts the original file information to native InDesign information:

- Text boxes are converted to InDesign text frames.

 *To accurately convert text wrap applied in QuarkXPress, select Text Wrap Only Affects Text Beneath in the Composition area of the Preferences dialog box.*

- Styles are converted to InDesign styles.
- Because QuarkXPress uses different color profiles, they are ignored in InDesign.
- Text and graphics links are preserved and appear in the Links panel.

Note: *Embedded graphics—those added to the original document using the Paste command—are not converted. For more information on embedded graphics, see [About links and embedded graphics](#).*

 *InDesign does not support OLE or Quark XTensions. Consequently, when you open files that contain OLE or Quark XTensions graphics, those graphics will not appear in the InDesign document. If your QuarkXPress document does not convert, check the original and remove any objects that were created by an XTension; then save, and try to convert again.*

- All master pages and layers are converted to InDesign masters and layers.
- All master-page objects, as well as QuarkXPress guides, are placed on the corresponding InDesign master pages.
- Grouped objects remain grouped except where nonprinting items are included in a group.
- All strokes and lines (including paragraph rules) are converted to the stroke styles they most closely resemble. Custom strokes and dashes are converted to custom strokes and dashes in InDesign.

Colors are converted exactly to InDesign colors, except in the following situations:

- Multi-ink colors from QuarkXPress are mapped to mixed inks in InDesign, unless the multi-ink color does not contain at least one spot color. In this case, the multi-ink color is converted to a process color instead.
- QuarkXPress 4.1 colors from the color library are converted based on their CMYK values.
- QuarkXPress 3.3 HSB colors are converted to RGB, and colors from the color library are converted based on their CMYK values.
- QuarkXPress 4.1 HSB and LAB colors are converted to RGB, and colors from the color library are converted based on their RGB/CMYK values.

For information about other conversion issues, check the support documents on the Adobe website at www.adobe.com/support.

[To the top](#)

Convert PageMaker documents

InDesign can convert document and template files from Adobe PageMaker 6.0 and later. When you open a PageMaker file, InDesign converts the original file information to native InDesign information. InDesign files are saved with an .indd filename extension.

 *For more information, see the [PageMaker Conversion Guide \(PDF\)](#) at www.adobe.com/go/learn_pmconv.*

Before opening the document in InDesign, you may want to do the following:

- If the PageMaker file or its linked graphics are located on a network server, floppy disk, or removable drive, it may not open as expected if an interruption in data transfer occurs. To prevent data transfer problems, copy documents and their links to the hard disk, preferably in the same folder where the PageMaker publication is stored, before opening them in InDesign.

- You may want to use Save As in PageMaker to clear unnecessary hidden data.
- To ensure that all links are maintained, copy all linked files to the same folder where the PageMaker publication is stored.
- Make sure that all necessary fonts are available in InDesign.
- Repair broken graphics links in the PageMaker publication.
- If you have a problem converting a large PageMaker document, convert portions of the PageMaker file separately to isolate the problem.

 *If you cannot open a corrupt PageMaker document in PageMaker, try opening it in InDesign. InDesign can recover most documents that PageMaker cannot open.*

Open a PageMaker document or template

1. Make sure that the original application file is closed.
2. In InDesign, choose File > Open.
3. In Windows, choose PageMaker (6.0-7.0) in the Files of Type menu.
4. Select a file and click Open.

Note: *If InDesign cannot convert a file or a specific part of a file, it displays a warning describing the reasons it cannot convert it and the results of the conversion attempt.*

5. If a warning dialog box appears, do one of the following:
 - Click Save to save a copy of the warnings as a text file, and then open the file in InDesign.
 - Click Close to open the file in InDesign without saving the text file.

 *If you're experiencing problems with the converted PageMaker document, use the Export dialog box to save the document in InDesign Markup (IDML) format. Then open the IDML file and save it as an InDesign document.*

Save a PageMaker template as an InDesign template

1. Open the template in InDesign.
2. Choose File > Save As and specify a location and filename.
3. Choose InDesign Template for Save As Type (Windows) or Format (Mac OS), and then click Save.

Common PageMaker conversion issues

Note the following:

- All master pages and layers are converted to InDesign masters and layers. Master pages in PageMaker convert to master pages in InDesign and retain all objects including page numbering and guides. To maintain the order of overlapping items, InDesign creates two layers when converting a PageMaker publication: Default and Master Default. Master Default contains the Master page items.
- PageMaker document guides are placed on the Default layer in InDesign.

- All items on the PageMaker pasteboard appear on the pasteboard of the first spread in the InDesign document.
- All objects designated in PageMaker as Non-Printing are converted with Nonprinting selected in the InDesign Attributes panel.
- Grouped objects remain grouped except where nonprinting items are included in a group.

Text and tables conversion issues

Note the following:

- Text is converted to InDesign text frames.
- Tables in PageMaker files are converted to InDesign tables.
- Styles are converted to InDesign styles. The [No style] in PageMaker is the equivalent of [No Paragraph Style] in InDesign. However, [No Paragraph Style] picks up the attributes of a named style if that style was selected before any typing occurred in the PageMaker publication.
- InDesign uses the Adobe Paragraph Composer for all paragraphs, causing some text to reflow. You can assign the Adobe Single-Line Composer to one or more paragraphs to create line breaks more similarly to the PageMaker composition engine, but text may still reflow.
- InDesign uses only Baseline leading. Proportional and Top of Caps leading in PageMaker convert to Baseline leading in InDesign, possibly resulting in text shifting.
- The First Baseline of converted text may appear different than text created in InDesign. The First Baseline of converted text is set to Leading, but the First Baseline of text created in InDesign is set to Ascent by default.
- InDesign uses a different hyphenation method than PageMaker, so line breaks may be different.
- Shadow text converts as plain text. Outline text converts as text with a stroke of 0.25 inches and a fill of Paper.

Book, index, and TOC conversion issues

Note the following:

- InDesign ignores Booklists when opening PageMaker publications. If you want to open all the publications on a Booklist together, run the Build Booklet plug-in in PageMaker with a layout of None selected so that the booked publications are combined into one. Note that text blocks and frames will no longer be threaded.
- Index entries from a PageMaker publication appear in the InDesign Index panel. Text with cross-references that use the See Herein or See Also Herein option are mapped as See or See Also.
- Table of Contents text converts as a Table of Contents, with PageMaker TOC Style available in the style pop-up menu in the InDesign TOC dialog box.

Linking and embedding conversion issues

Note the following:

- Text and graphics links are preserved and appear in the Links panel.
- If InDesign cannot locate the original link to a graphic, a warning appears asking you to repair the link in PageMaker.
- InDesign does not support OLE (object linking and embedding). Consequently, when you open files that contain OLE graphics, those graphics will not appear in the InDesign document.

Color and trapping conversion issues

Note the following:

- Colors are converted exactly to InDesign colors. PageMaker HLS colors are converted to RGB colors, and colors from other color libraries are converted based on their CMYK values.

- Tints are converted as percentages of the parent color. If the parent color isn't in the Swatches panel, it's added during conversion. When an object with a tint is selected, the parent color is selected in the Swatches panel, and the tint value appears in the pop-up menu.
- Color profiles for PageMaker files are converted directly. All Hexachrome colors are converted to RGB values. Profiles that are not ICC-compliant are replaced using the default CMS settings and profiles you specified for InDesign.
- All strokes and lines (including paragraph rules) are converted to the default stroke styles they most closely resemble. Custom strokes and dashes are converted to custom strokes and dashes in InDesign.
- InDesign does not support screen patterns or angles applied to TIFF images in Image Control; it drops these from imported TIFF files.
- When Auto-Overprint Black Strokes or Fills (or both) is selected in the Trapping Preferences dialog box in PageMaker, the setting carries over to InDesign, but Overprint Stroke or Overprint Fill is deselected in the Attributes panel.

 For information about other PageMaker conversion issues, check the support documents on the Adobe website.

Adobe also recommends

- [PageMaker Conversion Guide](#)

 Twitter™ and Facebook posts are not covered under the terms of Creative Commons.

[Legal Notices](#) | [Online Privacy Policy](#)

Assignment packages

- [Create and send packages \(InDesign\)](#)
- [Receive packages \(InCopy\)](#)
- [Receive return packages \(InDesign\)](#)

[To the top](#)

Create and send packages (InDesign)

Under ideal circumstances, all InDesign and InCopy users on the team have access to a server where assignment files are stored. However, if one or more users don't have access to a common server, you can create and distribute compressed assignment packages. After working on the assignment, the InCopy user repackages the assignment and returns it to be integrated into the InDesign document. Package files created in InDesign include the .icap extension. The return package files created in InCopy include the .idap extension.

There are two commands for packaging files: Package For InCopy and Package And Email. Use Package For InCopy to create a compressed package that you can distribute manually; use Package And Email to create a compressed package that is attached automatically to an e-mail message.

Note: Do not confuse an assignment package with the File > Package command in InDesign that lets you bundle and send a document and its assets to a printer.

Create a package for manual distribution

1. Create an assignment and add the content you want to include in the package.

Only content that is checked in can be included in the packaged assignment. If any content is checked out, you're prompted to check in content.

2. In the Assignments panel, select the assignment and choose Package For InCopy from the panel menu.
3. Specify a name and location for the package file, and click Save.

You can attach the package file to an e-mail message, upload it to an FTP server, or copy it to a disk or other external media.

Note: Choosing Edit > Undo after you create a package cancels the package and unlocks the items in the assignment, but it doesn't delete the package file from your computer or unsend the e-mail.

Create a package for e-mail (InDesign)

1. Create an assignment and add the content you want to include in the package.

Only content that is checked in is included in the packaged assignment. If any content is checked out, you're prompted to check in content.

2. In the Assignments panel, select the assignment and choose Package For InCopy And Email from the panel menu.

A compressed assignment package is created and attached to an e-mail message of your default e-mail application.

Note: If you want to use a different e-mail application, change the default e-mail application. See your system documentation for details.

3. Edit the e-mail message by adding a recipient and providing any instructions. Send the message.

All items in the assignment are checked out to the assigned user. However, the contents of the package itself aren't locked, so anyone can open the package and edit them.

Cancel a package

In some cases, the package you send isn't returned. For example, the message may have gotten lost, or the recipient may no longer work on the project. In such a situation, you can cancel a package.

1. In the Assignments panel, select the packaged assignment, and choose Cancel Package from the panel menu.
2. Click OK to cancel the package.

Canceling a package doesn't remove the package file from your computer.

When a package is cancelled, the package's contents are available for editing. Be aware that if someone returns a package that has been cancelled, conflicts may occur.

Update a package

After you create a package, you may want to add, remove, or resize items.

1. Add, remove, or resize one or more stories to the packaged assignment.
2. Select the assignment in the Assignments panel, and do one of the following:
 - Choose Update Package from the Assignments panel menu. Specify the name and location of the file. Make the updated package available to users by placing it on a shared server or by e-mail. Remember to notify InCopy users that the package has been updated.
 - Choose Update Package And Email from the Assignments panel menu, and then send the message.

When InCopy users open the updated package, only new content is added automatically to the assignment; InCopy users can decide whether to overwrite existing content, allowing them to preserve previous edits.

[To the top](#)

Receive packages (InCopy)

You may receive a package from an InDesign user who created the package or from an InCopy user who forwarded the package to you. When you open an assignment package, the package is decompressed, and the contents are copied to a new subfolder in an InCopy Assignments folder.

Open a package (InCopy)

- To open an InCopy package (*.icap or *.incp), do any of the following:
 - Launch the package using the e-mail application. For example, double-click the attachment file.
 - Use Explorer or Finder to open the file. For example, double-click the file or drag it to the InCopy application icon.

- In InCopy, choose File > Open, and double-click the packaged assignment file.
- In InCopy, choose Open Package from the Assignments panel menu, and then double-click the package file.

You can now edit the stories in the package. When you begin editing a story, you're prompted to check out the contents of the frame. When you've finished editing, save all content and return or forward the package.

Return or forward a package (InCopy)

After you open and edit a package, you can send it to another InCopy user or you can return it to the InDesign user who created the package. Package files created for other InCopy users include the .icap extension; return package files created for InDesign users include the .idap extension.

1. Edit and check in the content you want to include in the package.
2. From the Assignments panel menu, choose one of the following:

Forward For InCopy Create a package for another InCopy user. Specify the name and location of the package file, and then make it available to the InCopy user.

Forward For InCopy And Email Create and send a package for another InCopy user via e-mail. The package appears as an attachment in a new message in your default e-mail application. Specify the recipient, provide instructions, and send the e-mail message.

Return For InDesign Create a package to return to the InDesign user.

Return For InDesign And Email Create and return a package to the InDesign user by e-mail. The package appears as an attachment in a new message in your default e-mail application. Specify the recipient, provide instructions, and send the e-mail message.

[To the top](#)

Receive return packages (InDesign)

- To open an InDesign package (*.idap or *.indp), do any of the following:
 - Launch the package using the e-mail application. For example, double-click the attachment file.
 - Use Explorer or Finder to open the file. For example, double-click the file or drag it to the InDesign application icon.
 - In InDesign, choose File > Open, and double-click the package file.
 - In InDesign, choose Open Package from the Assignments panel menu, and then double-click the package file.

You're prompted to update all links when opening the package. If a story has been modified since the assignment was packaged, you can determine whether to update or unlink the content in the InDesign file. When the stories in the files are returned and checked in, you can check out and edit the content.

Adobe also recommends

 Twitter™ and Facebook posts are not covered under the terms of Creative Commons.

[Legal Notices](#) | [Online Privacy Policy](#)

Adjusting your workflow

- [Move content between assignments \(InDesign\)](#)
- [Delete assignments \(InDesign\)](#)
- [Relink missing assignment files \(InDesign\)](#)
- [Correct mistakes](#)
- [Overriding locked files \(InDesign\)](#)
- [Unlink content files \(InDesign\)](#)
- [Placing InCopy files in InDesign documents](#)

[To the top](#)

Move content between assignments (InDesign)

InDesign users can move content between existing assignments as well as from the Unassigned InCopy Content section of the Assignments panel. You can also create a new assignment and move content to it.

1. Save the InDesign document.
2. In the Assignments panel, click the arrow to the left of the assignment name to display the contents of the assignment.
3. Select an item in an assignment.
4. Do one of the following:
 - Drag the content from one assignment to another.
 - To move content to an existing assignment, choose **Add To Assignment** from the Assignments panel menu, and then select the desired assignment.
 - To create a new assignment as you move content, from the Assignments panel menu, choose **Add To Assignment > New**, and then specify options in the New Assignment dialog box.
5. Choose **Update All Assignments** from the Assignments panel menu.

 *If the assignment lists are short, you might prefer dragging content items to and from assignments and the Unassigned InCopy Content section.*

[To the top](#)

Delete assignments (InDesign)

- In the Assignments panel, select one or more assignments and choose **Delete Assignment** in the panel menu.

Deleting assignments accomplishes the following:

- Removes the assignment data from the document.
- Deletes the assignment file from the file system.
- Removes the assignment name from the list.
- Moves any InCopy content to the Unassigned InCopy Content section in the Assignments panel.

Note: *If an InCopy user has an assignment open when it is deleted in InDesign, an alert message notifies the InCopy user that the assignment*

has been deleted. However, the content files are not deleted and can be updated without loss of changes.

[To the top](#)

Relink missing assignment files (InDesign)

If you move or delete an assignment file from disk, and then open the InDesign document from which it was created, InDesign won't know where the assignment file is located. You need to re-create the assignment file so InDesign can find it.

Re-create the assignment file in the original location

- In the Assignments panel, do one of the following:
 - Select the missing assignment (it will still be listed in the panel) and choose Update Selected Assignments from the panel menu.
 - Choose Update All Assignments from the panel menu.

Change the assignment location

- To re-create the assignment file in a new location, do one of the following in the Assignments panel:
 - Select the assignment and choose Change Assignment Location from the panel menu. Specify a location and name for the new file.
 - Double-click the assignment name. In the Assignment Options dialog box, click Change and specify a location and name for the new file.

[To the top](#)

Correct mistakes

If you make a mistake, you can discard changes made since the last Save command and restore the content from the file system.

Because InDesign automatically saves every editable InCopy content file when you save the InDesign document, the Cancel Checkout command restores only versions since the last time the document was changed.

- Do one of the following:
 - To undo the most recent change, choose Edit > Undo *[action]*.
 - To undo all changes made since the last time you saved the document, choose File > Revert Content.
 - To undo changes since the last saved version and remove the lock file, select the content in the Assignments panel and choose Cancel Check Out from the panel menu. This action makes the content read-only and available for others to check out.

[To the top](#)

Overriding locked files (InDesign)

Users might not immediately realize how their actions affect others in the workflow, and might accidentally create situations where conflicts exist between content status and ownership. If necessary, the InDesign user can resolve conflicts by unlinking a locked file checked out to a different user and taking control over the file. Unlinking a file stores the content in the InDesign document, but the content is no longer shared with InCopy.

[To the top](#)

Unlink content files (InDesign)

If necessary (because of a production deadline, for example), InDesign users can remove a content file from the managed workflow and from the Links panel by *unlinking* it. If you want to make the content available again for editing, you must reexport it as InCopy content using a different file name. This ensures that the old lock file won't prevent users from editing the file.

Note: *Unlinking your own checked-out file removes it from the workflow and deletes the lock file from disk. You can re-export the content and overwrite the file name without conflict.*

- To unlink an InCopy content file, select the file (.icml or .incx extension) in the Links panel and choose Unlink from the panel menu. Unlinking embeds the content into the document and removes the link to the InCopy file on disk.

To relink the file, choose Edit > Undo Unlink.

 You can also unlink by deleting a frame, or using the InDesign Links panel to relink a content file to another file. You can also select the story in the Assignments panel and drag it to the Trash icon.

[To the top](#)

Placing InCopy files in InDesign documents

Although a typical workflow begins in InDesign, where the basic layout and text and graphics placeholders are defined and exported to InCopy, a different workflow can start with a stand-alone InCopy content file (.icml or .incx) that you place in InDesign using the File > Place command.

Consider the following dependencies when you place InCopy content files in an InDesign document:

Styles If the InCopy text file has styles applied, they are added to the InDesign list of styles for the document. In the event of a style-name conflict, InDesign overwrites the imported style with its existing style.

Layout You can create the basic layout geometry for the content in InDesign, and then create or import the text and styles from a word-processing application. (Text files placed within InCopy are embedded in the InCopy document and are not linked to any external file.)

Placing/Duplicating If you place an InCopy content file more than once, each instance of the content appears in the InDesign Links panel, but they are all managed as one content file. The same is true for any exact copies of a content file (by any means of duplication).

Note: *If you copy and paste some, but not all, of the text in a managed InCopy content file, the result is a new content file that is not connected to the original and has no link to any external file (InCopy or otherwise). The original and the pasted portions can be edited independently of each other.*

Updates/Management Once multiple instances of a managed content file are present in an InDesign document, they behave as if they were open in two applications. For example, checking out one instance of the content file locks all other instances so that you can edit only the checked-out instance. In this case, you would use the appropriate Update command to refresh the other (open) instances of the content.

Adobe also recommends

 Twitter™ and Facebook posts are not covered under the terms of Creative Commons.

[Legal Notices](#) | [Online Privacy Policy](#)

Layout and design

[Linking Content](#)

Anne-Marie Concepcion (May. 15, 2012)

video-tutorial

Watch this video tutorial to learn how to create and update links between objects in the same document and others.

[Reviewing the Forms tools](#)

Anne-Marie Concepcion (May. 15, 2012)

video-tutorial

An overview of the form field-related buttons, dialog boxes and menu commands in InDesign. Compare the old and new ways of creating interactive forms.

[Testing a form in Acrobat](#)

Anne-Marie Concepcion (May. 15, 2012)

video-tutorial

This tutorial shows you how InDesign form fields look in Acrobat or Reader. Then, learn how to continue modifying the interactive fields in Acrobat for additional functionality, and how the form performs in Acrobat.

[Working with Frames](#)

Kelly McCathran (May. 15, 2012)

video-tutorial

Everything that is placed into InDesign ends up in a frame. You can create frames from scratch, or if you "place" (import) text or images into a document, InDesign automatically creates the frame for you.

[Building a grid of objects quickly \(PDF, 100 KB\)](#)

article (Jan. 1, 2011)

Tutorial to build a grid of objects in InDesign CS5 and later.

[Creating cross-references \(video 5:45\), CS4-CS6](#)

David Blatner (Jan. 1, 2011)

video-tutorial

Walk through the procedure of adding cross-references. Create cross-references that can be updated quickly when the target text or pagination changes. Create a custom cross-reference format.

[Generating image captions with metadata \(PDF, 148 KB\)](#)

article (Jan. 1, 2011)

A short tutorial on how to work with metadata and auto-generate captions for images in your layout.

[Grid Mode and Live Distribute \(video 2:48\)](#)

Michael Ninness (Jan. 1, 2011)

video-tutorial

Watch how you can quickly create grids on the fly using design tools that are "gridified".

[Live captions \(video 3:04\)](#)

Michael Ninness (Jan. 1, 2011)

video-tutorial

See how InDesign CS5 and later allow you to take advantage of metadata embedded in an image to create live captions and then automatically and flexibly place them in your layout.

[Making shiny graphics \(PDF, 203 KB\)](#)

Mike Rankin (Jan. 1, 2011)

article

This tutorial shows you how to apply a shiny, glossy effect on objects in your layout.

[Managing documents with multiple page sizes \(PDF, 136 KB\)](#)

article (Jan. 1, 2011)

A short tutorial on how to manage documents with multiple page sizes, in InDesign CS5 and later.

[Mini Bridge: Getting access to your assets \(PDF, 180 KB\)](#)

article (Jan. 1, 2011)

Use Bridge as a floating panel inside InDesign. yes Mini Bridge.

[Mixing page sizes with the new Page tool \(video 8:03\)](#)

Anne-Marie Concepcion (Jan. 1, 2011)

video-tutorial

Create complete brochures and book covers along with text with the new ability to mix page sizes within a single file

[Paragraphs that span and split columns \(video 2:01\)](#)

Michael Ninness (Jan. 1, 2011)

video-tutorial

See how to build complex layouts in less clicks with paragraphs that span or split columns in InDesign CS5 and later.

[Rotating Spread view \(video 3:31\), CS4-CS6](#)

David Blatner (Jan. 1, 2011)

video-tutorial

When one or more objects on a page is rotated, learn how to rotate the spread view to make easy edits. Discover a number of navigation tips to save time.

[Spanning and Splitting columns \(video 6:15\)](#)

Anne-Marie Concepcion (Jan. 1, 2011)

video-tutorial

Set up spanning heads over any number of columns or split a group of columns into additional columns to save vertical space.

Create new documents

- [Creating new documents](#)
- [Create a new document](#)
- [New Document options](#)
- [Document window overview](#)
- [Create custom page sizes](#)
- [Define document presets](#)
- [Create a document using a preset](#)

Page design begins with the basics: starting a new document, setting up pages, and positioning margins and columns or changing grid settings.

[To the top](#)

Create a new document

1. Choose File > New > Document.

The New Document dialog box combines the Document Setup and the Margins And Columns dialog boxes, so that you can set up the page size, margins, and page columns all in one place. You can change these settings at any time.

2. Specify document setup options. (See [New Document options](#).)

To specify the dimensions of the bleed and slug areas, click the Arrow button before the Bleed and Slug label. The bleed and slug areas extend out from the edges of the defined Page Size. To make the bleed or slug areas extend evenly on all sides, click the Make All Settings The Same icon .

3. (Only in InDesign CC) Select the Preview checkbox to see how your new document will look like. Make necessary changes if required.

4. Click OK to open the new document with the settings you specified.

 *To set default layout settings for all new documents, choose File > Document Setup or Layout > Margins And Columns, and set options when no documents are open.*

[To the top](#)

New Document options

Document Preset Choose a preset that you have saved earlier.

Intent If you are creating a document to be output to PDF or SWF for the web, choosing the Web option changes several options in the dialog box, such as turning off Facing Pages, changing the orientation from portrait to landscape, and using a page size based on monitor resolution. You can edit any of these settings after the document is created.

CS6 and later: Digital publishing intent has been added for publications aimed for the Digital Publishing Suite. You can also change the intent of the document after it is created.

Number of pages Specify the number of pages to create in the new document.

Start Page # Specify which number the document starts on. If you specify an even number (such as 2) with Facing Pages selected, the first spread in the document begins with a two-page spread. See [Start a document with a two-page spread](#).



Facing Pages Select this option to make left and right pages face each other in a double-page *spread*, such as for books and magazines. Deselect this option to let each page stand alone, such as when you're printing flyers or posters or when you want objects to *bleed* in the binding. After you've created a document, you can use the Pages panel to create spreads with more than two pages or force the first two pages to open as a spread. (See [Control spread pagination.](#))

Master Text Frame *CS5.5 and earlier.* Select this option to create a text frame the size of the area within the margin guides, matching the column settings you specified. The master text frame is added to the A Master. (See [Using text frames on master pages.](#))

The Master Text Frame option is available only when you've chosen File > New > Document.

Primary Text Frame *CS6 and later.* select this option to add a primary text frame on the master page. When you apply a new master page, the story in the primary text frame automatically flows into the primary text frame of the new master page.

Page Size Choose a page size from the menu, or type values for Width and Height. Page size represents the final size you want after bleeds or other marks outside the page are trimmed.

Orientation Click Portrait  (tall) or Landscape  (wide). These icons interact dynamically with the dimensions you enter in Page Size. When Height is the larger value, the portrait icon is selected. When Width is the larger value, the landscape icon is selected. Clicking the deselected icon switches the Height and Width values.

Tip: To specify the dimensions of the bleed and slug areas, click the Arrow button before the Bleed and Slug label in the New Document dialog box. To make the bleed or slug areas extend evenly on all sides, click the Make All Settings The Same icon .

Bleed The Bleed area allows you to print objects that are arranged at the outer edge of the defined page size. For a page of the required dimensions, if an object is positioned at its edge, some white may appear at the edge of the printed area due to slight misalignment during printing or trimming. For this reason, you should position an object that is at the edge of the page of the required dimensions a little beyond the edge, and trim after printing. Bleed area is shown by a red line on the document. You can set bleed area settings from Bleed in the Print dialog box.

Slug The slug area is discarded when the document is trimmed to its final page size. The slug area holds printing information, customized color bar information, or displays other instructions and descriptions for other information in the document. Objects (including text frames) positioned in the slug area are printed but will disappear when the document is trimmed to its final page size.

Objects outside the bleed or slug area (whichever extends farther) do not print.

Preview (*Only in InDesign CC*) Select this checkbox to see how your new document will look like. Make necessary changes to the options if the preview is not as desired.

Note: You can also click the Save Document Preset icon to save document settings for future use.

[To the top](#)

Document window overview

Each page or spread in your document has its own pasteboard and guides, which are visible in Normal View mode. (To switch to Normal View, choose View > Screen Mode > Normal.) The pasteboard is replaced with a gray background when the document is viewed using one of the Preview modes. (See [Preview documents.](#)) You can change the color of this preview background and guides in Guides & Pasteboard preferences.

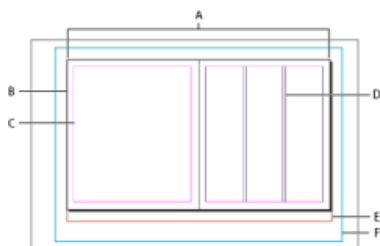

Document and guides in Normal View Mode

A. Spread (black lines) **B.** Page (black lines) **C.** Margin guides (magenta lines) **D.** Column guides (violet lines) **E.** Bleed area (red lines) **F.** Slug area (blue lines)

Document window notes:

- Lines of other colors are ruler guides which, when present, appear in the layer color when selected. See [Layers](#).
- Column guides appear in front of margin guides. When a column guide is exactly in front of a margin guide, it hides the margin guide.

[To the top](#)

Create custom page sizes

You can create custom page sizes that appear in the Page Size menu in the New Document dialog box.

1. Choose File > New > Document.
2. Choose Custom Page Size from the Page Size menu.
3. Type a name for the page size, specify page size settings, and then click Add.

The New Doc Sizes.txt file that lets you create custom page sizes in previous version of InDesign is not available in InDesign CS5 or later.

[To the top](#)

Define document presets

You can save document settings for page size, columns, margins, and bleed and slug areas in a preset to save time and ensure consistency when creating similar documents.

1. Choose File > Document Presets > Define.
2. Click New in the dialog box that appears.
3. Specify a name for the preset and select basic layout options in the New Document Preset dialog box. (See [New Document options](#) for a description of each option.)
4. Click OK twice.

 You can save a document preset to a separate file and distribute it to other users. To save and load document preset files, use the Save and Load buttons in the Document Presets dialog box.

[To the top](#)

Create a document using a preset

1. Do one of the following:
 - Choose File > Document Preset > *[name of preset]*. (Hold down Shift while choosing the preset to create a new document based on the preset without opening the New Document dialog box.)
 - Choose File > New > Document, and then choose a preset from the Document Preset menu in the New Document dialog box.

The New Document dialog box displays the preset layout options.

2. Make changes to the options (if desired) and click OK.

 *To skip the New Document dialog box, press the Shift key as you select a preset from the Document Preset menu.*

- [Recommended workflow for InDesign documents](#)
- [Use document templates](#)
- [Add documents to a book file](#)
- [Change document setup, margins, and columns](#)

 Twitter™ and Facebook posts are not covered under the terms of Creative Commons.

[Legal Notices](#) | [Online Privacy Policy](#)

Generate QR codes | CC

[About QR codes](#)

[Manage QR codes in InDesign](#)

[To the top](#)

About QR codes

QR codes are machine readable printed representation of data for various industry uses. It has now become common in consumer advertising. A consumer with a Smartphone can install an app with a QR code scanner that can read and decode the URL information and redirect the phone's browser to a company website.

After scanning QR codes, users may receive text, add a business card contact to their devices, open a Web hyperlink, or compose an email or text message.

[To the top](#)

Manage QR codes in InDesign

You can now generate and edit high quality independent QR code graphics from within InDesign. The generated QR code is a high-fidelity graphic object that behaves exactly like native vector art in InDesign. You can easily scale the object and fill it with colors. You can also apply effects, transparency, and printing attributes, such as overprinting, spot inks, and trappings to the object. You can copy-paste the code graphic as a vector graphic object into a standard graphics editor tool such as Adobe Illustrator.

Generate QR code

1. From the menu, choose Object > Generate QR Code. The Generate QR Code dialog box is displayed.

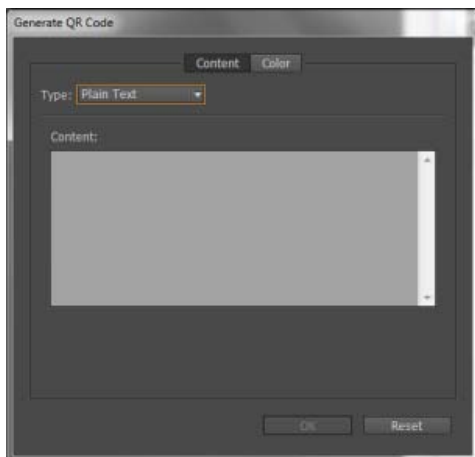

The Generate/Edit QR Code dialog box has two tabs – Content and Color.

2. In the Content tab, select any one of the following data types in the Type drop-down list:
 - Web Hyperlink

- Plain Text
- Text Message
- Email
- Business Card

Based on the selected type, one or more fields are displayed to provide the content for which you want to generate the QR code.

3. The Color tab shows Swatch List. If you want to apply a specific color to the QR code, switch to the Color tab and select a specific color. By default, the generated QR code is Black with transparent background.
4. Click OK.
5. If you have selected a Frame before generating the QR code, the code is placed directly in the selected Frame replacing its content.

If you have not selected a frame, the QR code is loaded on the Place Gun and you can place it just like a traditional EPS object:

- Clicking inside the document places the object in its original/default size – 30 X 30 (cm units).
- Clicking into an existing frame places the code inside the frame with default size. (It replaces its existing content if you click in the frame with the Alt key pressed.)
- Click and dragging draws a new frame with fixed aspect ratio and releasing the mouse places the code inside the frame.

Once placed inside a document, the QR code is treated as a traditional EPS object, except that a tooltip appears on hovering over the object, revealing the content details in the form of the embedded code.



Edit the content and color of the QR code

1. Select the QR code object or the frame: double-click inside the frame.
2. From the menu, choose Object > Edit QR Code. You can also right-click and choose Edit QR Code in the context menu.
3. The Edit QR Code dialog box is displayed with the existing content and color information.
4. In the Content tab, change the data type and content as appropriate.
5. To select a different color for the QR code, click Color tab and select an appropriate color.
6. Click OK.

Modify the QR code's frame attribute

The default background of a QR code frame is transparent. However, you can change the Frame's Fill and Stroke attributes such as the Color, Line Style, and Thickness using the traditional controls.



Transform the QR code object

You can move, resize, or rotate the placed QR code object with the Selection tool. When you drag the frame's box, only the frame resizes. However, while dragging:

- If you press the Shift key, the aspect ratio of the frame is preserved.
- If you press the Ctrl (on Windows) or Command (on Mac) key, both the frame and the content scales with preserved aspect ratio.
- If you press the Shift plus Alt (on Windows) or Option (on Mac) keys, the frame scales from its center with unpreserved aspect ratio. You can press the Shift key to preserve the aspect ratio.



 Twitter™ and Facebook posts are not covered under the terms of Creative Commons.

[Legal Notices](#) | [Online Privacy Policy](#)

Creating text and text frames

[Create text frames](#)

[Move and resize text frames](#)

[Using text frames on master pages](#)

[Change text frame properties](#)

[Determine word and character counts](#)

[Working with additional languages](#)







[To the top](#)

Create text frames

Text in InDesign resides inside containers called *text frames*. (A text frame is similar to a text box in QuarkXPress and a text block in Adobe PageMaker.)

There are two types of text frames: frame grids and plain text frames. *Frame grids* are the kind of text frames specific to Asian-language composition in which character embboxes and spacing are displayed as grids. Empty text frames in which no grid is displayed are *plain text frames*.

Like graphics frames, text frames can be moved, resized, and changed. The tool with which you select a text frame determines the kind of changes you can make:

- Use the Type tool  to enter or edit text in a frame.
- Use the Selection tool  for general layout tasks such as positioning and sizing a frame.
- Use the Direct Selection tool  to alter a frame's shape.
- Use the Horizontal Grid tool  or the Vertical Grid tool  to create a frame grid. See [Create frame grids](#).
- Use the Type tool  to create a plain text frame for horizontal text, and the Vertical Type tool  to create a plain text frame for vertical text. Use the same tools to edit existing text in a frame.

Text frames can also be connected to other text frames so that the text in one frame can flow into another frame. Frames that are connected in this way are *threaded*. Text that flows through one or more threaded frames is called a *story*. When you place (import) a word-processing file, it comes into your document as a single story, regardless of the number of frames it may occupy.

Text frames can have multiple columns. Text frames can be based on, yet independent of, page columns. In other words, a two-column text frame can sit on a four-column page. Text frames can also be placed on master pages and still receive text on document pages.

 *If you use the same type of text frame repeatedly, you can create an object style that includes text frame formatting such as stroke and fill colors, text frame options, and text wrap and transparency effects.*

When you place or paste text, you don't need to create a text frame; InDesign automatically adds frames based on the page's column settings.

When text is pasted, a plain text frame is automatically created. You can also create an empty plain text frame manually and input text.

- Do any of the following:
 - Select the Type tool , and then drag to define the width and height of a new text frame. Hold down Shift as you drag to constrain the frame to a square. When you release the mouse button, a text insertion point appears in the frame.

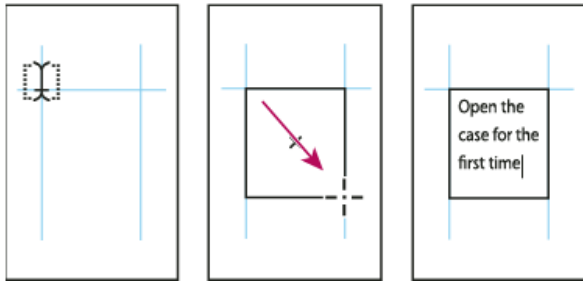

Dragging to create new text frame

- Using the Selection tool, click the in port or out port of another text frame, and then click or drag to create another frame.
- Use the Place command to place a text file.
- Using the Type tool **T**, click inside any empty frame. If the Type Tool Converts Frames To Text Frames option is selected in Type preferences, the empty frame is converted to a text frame.

[To the top](#)

Move and resize text frames

Use the Selection tool to move or resize text frames.

 If you want to move or resize a text frame without switching from the Type tool to a selection tool, hold down **Ctrl** (Windows) or **Command** (Mac OS), and then drag the frame.

Move a text frame

- Using the Selection tool, drag the frame.
- Using the Type tool, hold down **Ctrl** (Windows) or **Command** (Mac OS) and drag the frame. When you release the key, the Type tool is still selected.

Resize a text frame

- Do any of the following:
 - To resize using the Type tool **T**, hold down **Ctrl** (Windows) or **Command** (Mac OS), and drag any frame handle. If you hold down the mouse button for one second before you begin dragging, the text will recompose while you resize the frame.

Note: If you click the text frame instead of dragging it, you'll lose your text selection or insertion point location.
 - To resize using the Selection tool , drag any of the frame handles on the frame's border. Hold down **Ctrl** (Windows) or **Command** (Mac OS) to scale the text within the frame. (See *Scale type*.)
 - To quickly fit the frame to its content, use the Selection tool to select the text frame, and double-click any handle. For example, if you double-click the center bottom handle, the bottom of the frame snaps to the bottom of the text. If you double-click the center right handle, the height is preserved while the width narrows to fill the frame.

Tip: You can also double-click a handle on an overset text frame to expand the height or width to fit all text in the frame. If a text frame includes more overset text than can reasonably fit on the page, the text frame isn't resized.

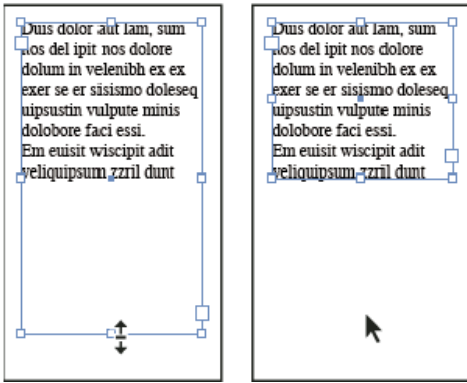

Double-click handle to resize text frame

- To fit the text frame to the content, select the frame using the Selection tool, and choose Object > Fitting > Fit Frame to Content. The bottom of the text frame fits the contents of the text. If a text frame includes more overset text than can reasonably fit on the page, the text frame isn't resized.
- To resize using the Scale tool , drag to resize the frame. (See Scale type.)

[To the top](#)

Using text frames on master pages

When you start a new document, you can select the Master Text Frame option so that an empty text frame is placed on the document's default master page. This frame has the column and margin attributes specified in the New Document dialog box.

Follow these guidelines for using text frames on master pages:

- Set master text frames when you want each page in your document to contain a page-sized text frame into which you can flow or type your text. If your document requires more variation, such as pages with different numbers of frames or frames of different lengths, leave the Master Text Frame option deselected, and use the Type tool to create text frames on masters.
- Whether or not you select the Master Text Frame option, you can add text frames to a master page to act as placeholders. You can thread these empty placeholder frames together to establish a flow.
- Flow text into master text frames using the same procedures you would use with frames created on document pages.
- If you need to type text in a master text frame on a document page, hold down Ctrl+Shift (Windows) or Command+Shift (Mac OS) as you click the text frame on the document page. Then click in the frame using the Type tool and begin typing.
- You can use Smart Text Reflow to add or remove pages automatically as you type and edit text. By default, when you type text at the end of a threaded text frame based on a master page, a new page is added, allowing you to continue typing in the new text frame. You can edit Smart Text Reflow settings.
- If you change the page margins, text frames adjust to the new margins only if the Enable Layout Adjustment option is selected.
- Selecting the Master Text Frame option does not affect whether new pages are added when you autoflow text.

[To the top](#)

Change text frame properties

Use Text Frame Options to change settings such as the number of columns in the frame, the vertical alignment of text within the frame, or the *inset spacing*, which is the distance of the margins between the text and the frame.

Open the case for the first time and take in the sights and smells of your hand-made instrument. See the way the light reflects off the handrubbed satin finish. Breathe in the perfume of the finest exotic tone woods. Then, finally, take it in your hands and begin to play. The experience will leave you swept away, and your life and your music will never be the same again.

For the select few thousand people across the continent playing Antares it's no mystery why our guitars look and sound so different from the multitude of other instruments available to the discerning musician and collector. To this day, each guitar, mandolin, banjo, and dulcimer produced at Antares is afforded the same care and attention to detail as those he created. Open the case for the first time and take in the sights and smells of your hand-made instrument. See the way the light reflects off the handrubbed satin finish. Breathe in the perfume of the finest exotic tone woods. Then, finally, take it in your hands and begin to play. The experience will leave you swept away, and your life and your music will never be the same again.

For the select few thousand people across the continent playing Antares it's no mystery why our guitars look and sound so different from the multitude of other instruments available to the

Open the case for the first time and take in the sights and smells of your hand-made instrument. See the way the light reflects off the handrubbed satin finish. Breathe in the perfume of the finest exotic tone woods. Then, finally, take it in your hands and begin to play. The experience will leave you swept away, and your life and your music will never be the same again.	discerning musician and collector. To this day, each guitar, mandolin, banjo, and dulcimer produced at Antares is afforded the same care and attention to detail as those he created. Open the case for the first time and take in the sights and smells of your hand-made instrument. See the way the light reflects off the handrubbed satin finish. Breathe in the perfume of the finest exotic tone woods. Then, finally, take it in your hands and begin to play. The experience will leave you swept away, and your life and your music will never be the same again.
For the select few thousand people across the continent playing Antares it's no mystery why our guitars look and sound so different from the multitude of other instruments available to the	

Before (left) and after (right) setting inset and creating two columns in a text frame

 If you need to use the same text frame properties for multiple text frames, create an object style that you can apply to your text frames.

1. Using the Selection tool , select a frame, or using the Type tool **T**, click inside the text frame or select text.
2. Choose Object > Text Frame Options, or hold down Alt (Windows) or Option (Mac OS) and then double-click the text frame using a selection tool.
3. Change text frame options, and then click OK.

These text frame options are available when you're defining an object style for text boxes. See Object styles.

Add columns to a text frame

You can create columns within a text frame by using the Text Frame Options dialog box.

 You cannot create columns of unequal width in a text frame. To create columns of unequal width or height, add threaded text frames side-by-side on either a document page or a master page.

1. Using the Selection tool, select a frame, or using the Type tool, click inside the text frame or select text.
2. Choose Object > Text Frame Options.
3. Specify the number of columns, the width of each column, and the spacing between each column (gutter) for the text frame.
4. (Optional) Select Fixed Column Width to maintain column width when you resize the frame. If this option is selected, resizing the frame can change the number of columns, but not their width.

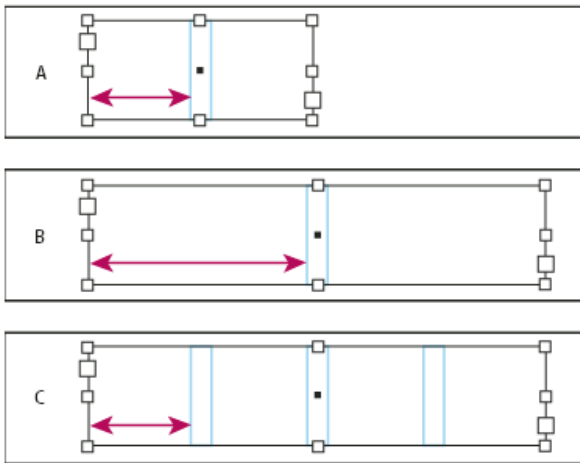

Fixed column width

A. Original 2-column text frame **B.** Resized with Fixed Column Width deselected (still 2 columns) **C.** Resized with Fixed Column Width selected (4 columns)

- (Optional) Select Balanced Columns to make text even at the bottom of a multi-column text frame.

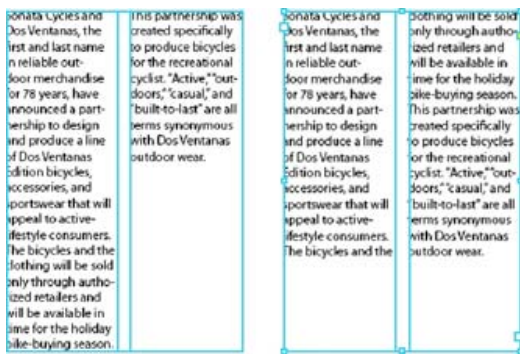

Before and after balancing columns

Change text frame inset spacing (margins)

- Using the Selection tool, select a frame, or using the Type tool, click inside the text frame or select text.
- Choose Object > Text Frame Options.
- In the Inset Spacing section on the General tab, type the offset distances you want for Top, Left, Bottom, and Right. (Click the Make All Settings The Same icon  to use the same spacing on all sides.)

If the frame you've selected has a non-rectangular shape, the Top, Left, Bottom, and Right options are dimmed, and an Inset option is available instead.

First baseline offset options

To change the first baseline options of a selected text frame, choose Object > Text Frame Options, and click the Baseline Options tab. The following options appear in the Offset menu under First Baseline:

Ascent The height of the “d” character in the font falls below the top inset of the text frame.

Cap Height The top of uppercase letters touch the top inset of the text frame.

Leading Use the text’s leading value as the distance between the baseline of the first line of text and the top inset of the frame.

X Height The height of the “x” character in the font falls below the top inset of the frame.

Fixed Specify the distance between the baseline of the first line of text and the top inset of the frame.

Min Select a minimum value for the baseline offset. For example, if Leading is selected and you specify a minimum value of 1p, InDesign uses the leading value only when it’s greater than 1 pica.

 *If you want to snap the top of the text frame to a grid, choose either Leading or Fixed so that you can control the location of the first baseline of text in text frames.*

Set baseline grids for a text frame

In some cases, you might want to use a baseline grid for a frame rather than for the entire document. Use the Text Frame Options dialog box to apply a baseline grid to a text frame. When you set up a baseline grid for a text frame, note the following:

- The document baseline grid doesn’t appear behind or in front of text frames that use their own baseline grids.
- If Grids In Back is selected in Grids Preferences, then frame-based baseline grids take precedence over document-based baseline grids. If Grids In Back is not selected, then document-based baseline grids take precedence over frame-based baseline grids.

1. Choose View > Grids & Guides > Show Baseline Grid to display all baseline grids, including those in a text frame.
2. Select the text frame or place the insertion in a text frame, and then choose Object > Text Frame Options.

If you want the baseline grid to apply to all frames in a thread (even if one or more threaded frames do not include text), place the insertion point in text, choose Edit > Select All, and then apply the baseline grid settings in the Text Frame Options dialog box.

3. Click the Baseline Options tab.
4. Under Baseline Grid, select Use Custom Baseline Grid, and do any of the following:

Start Type a value to offset the grid from the top of the page, the top margin of the page, the top of the frame, or the top inset of the frame, depending on what you choose from the Relative To menu.

Relative To Specify whether you want the baseline grid to begin relative to the top of the page, the top margin of the page, the top of the text frame, or the top of the text frame inset.

Increment Every Type a value for the spacing between grid lines. In most cases, type a value that equals your body text leading, so that lines of text align perfectly to the grid.

Color Select a color for the grid lines, or choose (Layer Color) to use the same color as the layer on which the text frame appears.

 *If you can’t see the baseline grid in a text frame, choose View > Grids & Guides > Show Baseline Grid to make sure that baseline grids aren’t hidden. If the baseline grid still doesn’t appear, check the threshold for viewing baseline grids in the Grids section of the Preferences dialog box. To see the grid, you might need to zoom in on the frame or reduce the threshold level.*

Determine word and character counts

1. Place the insertion point in a text frame to view counts for the entire thread of frames (the story), or select text to view counts only for the selected text.
2. Choose Window > Info to display the Info panel.

The Info panel displays the number of characters, words, lines, and paragraphs in a text frame. The position of the insertion point within the text frame also appears.

Working with additional languages

You can assign languages to different text. Assigning the appropriate language to text is especially useful for spell-checking and hyphenating. (See [Assign a language to text.](#))

If you need to work with Asian text, special versions of InDesign are available for Japanese, Simplified Chinese, Traditional Chinese, and Korean. These versions let you create layout grids and frame grids for composing multibyte characters, and they include a number of features for formatting multibyte text, along with additional fonts.

Similarly, a special version of InDesign is available for formatting Middle Eastern languages, such as Hebrew, Arabic, Farsi, and Urdu, that use right-to-left text formatting. This version is called InDesign ME.

For more information on purchasing InDesign ME or an Asian-language version of InDesign, see the [Adobe website](#).

Adobe also recommends

 Twitter™ and Facebook posts are not covered under the terms of Creative Commons.

[Legal Notices](#) | [Online Privacy Policy](#)

Aligning and distributing objects

[Align panel overview](#)

[Align or distribute objects](#)

[Align objects using the Gap tool](#)

[Distribute objects using Live Distribute](#)

[To the top](#)

Align panel overview

You use the Align panel (Window > Object & Layout > Align) to align or distribute objects horizontally or vertically along the selection, margins, page, or spread. Consider the following when working with the Align panel:

- The Align panel doesn't affect objects to which you've applied the Lock Position command, and doesn't change the alignment of text paragraphs within their frames.
- Text alignment is not affected by the Align Objects options. (See Align or justify text.)
- You can use the Keyboard Shortcuts dialog box (Edit > Keyboard Shortcuts) to create custom align and distribute shortcuts. (Under Product Area, select Object Editing.)



Align panel

A. Vertical alignment buttons **B.** Vertical distribution buttons **C.** Use Spacing distribution **D.** Horizontal alignment buttons **E.** Horizontal distribution buttons **F.** Alignment location options

[To the top](#)

Align or distribute objects

You can use the Align panel to align or space selected objects horizontally or vertically to the selection, margins, page, or spread.

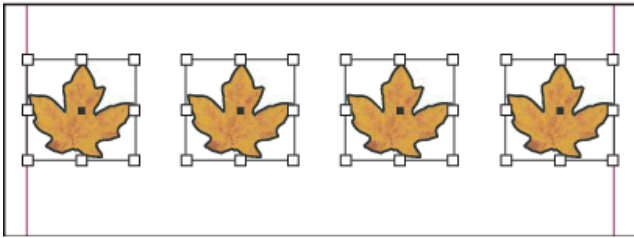
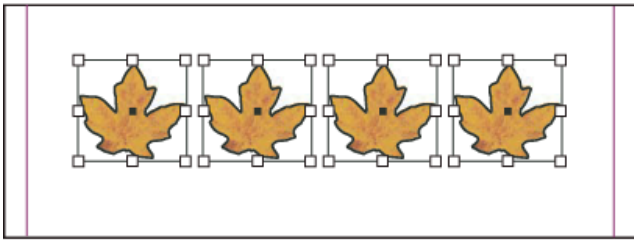

Objects distributed horizontally to selection (top) and to margins (bottom)

1. Select the objects to align or distribute.
2. Choose Window > Object & Layout > Align to display the Align panel.
 - 💡 To show or hide additional panel options, choose Show Options or Hide Options from the panel menu.
3. From the menu at the bottom of the panel, specify whether you want to align or distribute objects based on the selection, margins, page, or spread.
4. Do one of the following:
 - To align objects, click the button for the type of alignment you want.
 - To distribute objects, click the button for the type of distribution you want. For example, if you click the Distribute Left Edges button when Align To Selection is turned on, InDesign makes sure that there is an equal amount of space from left edge to left edge of each selected object.

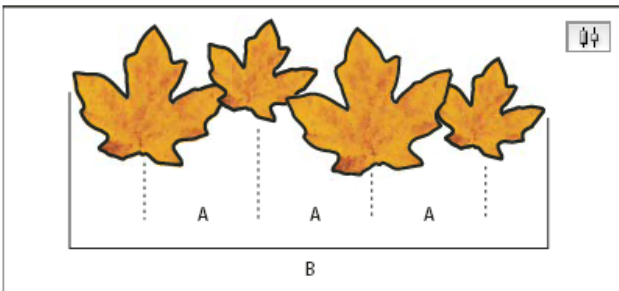

Using the Distribute Horizontal Centers option for even spacing

A. Creates even spacing between the centers of each object **B.** Keeps the overall width the same as before the transformation

- To set the space between objects, either center to center or edge to matching edge, select Use Spacing under Distribute Objects, and then type the amount of space you want to apply. Click a button to distribute the selected objects along their horizontal or vertical axes.

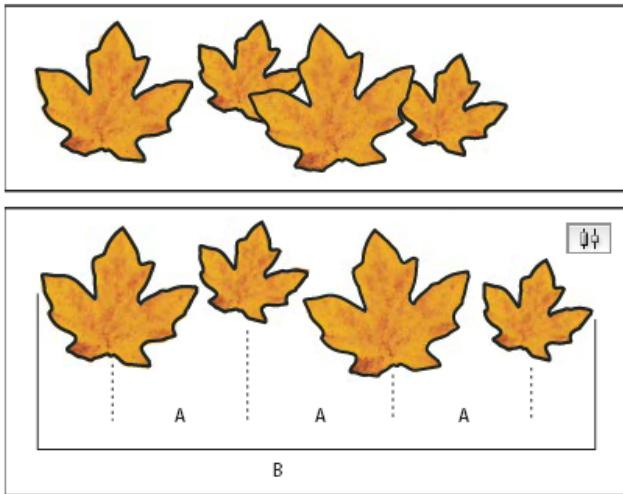

Using the *Distribute Horizontal Centers* option and adding a value for *Use Spacing*
A. Spaces the objects evenly from their centers by a specified value **B.** Changes the overall width of the objects as a whole

- To set the space between objects (facing edge to facing edge), under *Distribute Spacing*, select *Use Spacing* and type the amount of space you want between the objects. (If *Distribute Spacing* is not visible, choose *Show Options* in the *Align Panel* menu.) Then, click the *Distribute Spacing* button to distribute the objects along their horizontal or vertical axes.

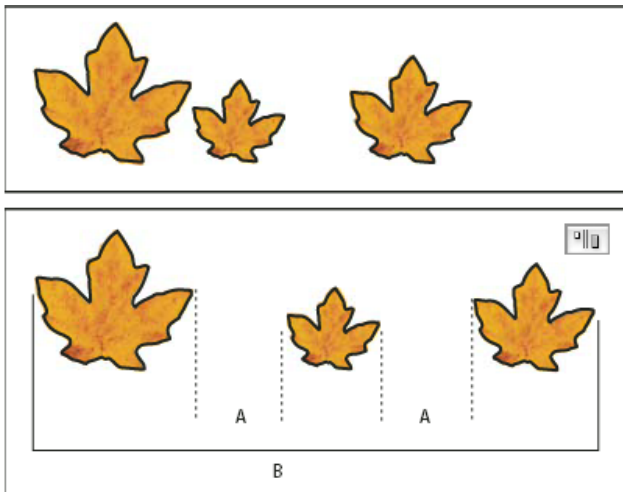

Using the *Distribute Horizontal Space* option and adding a value for *Use Spacing*
A. Creates spaces of a specified value between each object **B.** Changes the overall width of the objects as a whole

When you use spacing with vertical distribution, selected objects are spaced from top to bottom, starting with the top-most object. When you use spacing with horizontal distribution, selected objects are spaced from left to right, starting from the left-most object.

 You can also use the *Smart Spacing* feature to align or distribute objects while moving them. For example, if two vertical objects are 12 points apart, moving a third object 12 points below the second object causes temporary guides to appear, allowing you to snap the object into alignment.

[To the top](#)

Align objects using the Gap tool

The Gap tool provides a quick way to adjust the size of a gap between two or more objects. It also lets you resize several objects that have commonly aligned edges simultaneously, while keeping the gaps between them fixed. It's a one-step way to adjust your layout by directly manipulating the space between objects.

The Gap tool ignores locked objects and master page items.

1. Select the Gap tool .
2. Move the pointer between two objects, and do any of the following actions:
 - Drag to move the gap and resize all objects aligned along the gap.
 - Shift-drag to move the gap between only the two nearest objects.
 - Ctrl-drag (Windows) or Command-drag (Mac OS) to resize the gap instead of moving it. Adding the Shift key resizes the gap between only the two nearest objects.
 - Alt-drag (Windows) or Option-drag (Mac OS) to move the gap and objects in the same direction. Adding the Shift key moves only the two nearest objects.
 - Ctrl+Alt-drag (Windows) or Command+Option-drag (Mac OS) to resize the gap and move the objects. Adding the Shift key to resize the gap and move only the two nearest objects.

 To view hints on using the Gap tool, select the Gap tool and open the Tool Hints panel (Window > Utilities > Tool Hints).

[To the top](#)

Distribute objects using Live Distribute

When transforming multiple selected objects, you can resize the space between the selected objects proportionally instead of resizing the actual objects. For example, if you want to change the spacing between five aligned rectangles, you can do so without using any Distribute commands.

For a video on using Live Distribute, see <http://tv.adobe.com/go/4949/>.

1. Select the objects.
2. Start dragging a selection handle and hold down the Spacebar while dragging. Continue dragging to change the spacing between the objects.

Adobe also recommends

 Twitter™ and Facebook posts are not covered under the terms of Creative Commons.

[Legal Notices](#) | [Online Privacy Policy](#)

Footnotes

[Create footnotes](#)

[Change footnote numbering and layout](#)

[Delete footnotes](#)

[Work with footnote text](#)

[To the top](#)

Create footnotes

A *footnote* consists of two linked parts: the footnote reference number that appears in text, and the footnote text that appears at the bottom of the column. You can create footnotes or import them from Word or RTF documents. Footnotes are automatically numbered as they are added to a document. Numbering restarts in each story. You can control the numbering style, appearance, and layout of footnotes. You cannot add footnotes to tables or to footnote text.

The width of the footnote text is based on the width of the column containing the footnote reference marker. Footnotes cannot space columns in a text frame.

You cannot create endnotes in InDesign. However, Bob Bringhurst provides a workaround for creating endnotes at [Endnotes in InDesign](#). Endnotes in converted Microsoft Word documents are formatted as text, not footnotes.

1. Place the insertion point where you want the footnote reference number to appear.
2. Choose Type > Insert Footnote.
3. Type the footnote text.

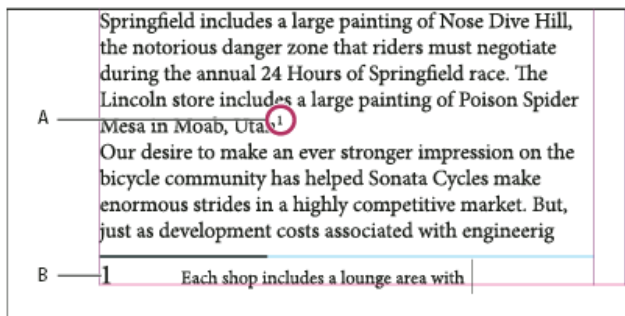

Footnote added to document

A. Reference number **B.** Footnote text

As you type, the footnote area expands while the text frame remains the same size. The footnote area continues to expand upward until it reaches the line with the footnote reference. At that point, the footnote is split to the next text frame column or threaded frame, if possible. If the footnote cannot be split and if more text is added than can fit in the footnote area, the line containing the footnote reference is moved to the next column, or an overset icon appears. In such a case, you should resize the frame or change the text formatting.

 When the insertion point is in a footnote, you can choose Type > Go To Footnote Reference to return to where you were typing. If you use this option frequently, consider creating a keyboard shortcut.

[To the top](#)

Change footnote numbering and layout

Changes you make to footnote numbering and layout affect existing footnotes and all new ones.

1. Choose Type > Document Footnote Options.
2. In the Numbering And Formatting tab, select options that determine the numbering scheme and formatting appearance of the reference number and footnote text.
3. Click the Layout tab, and select options that control the look of the footnote section on the page.
4. Click OK.

Footnote numbering and formatting options

The following options appear in the Numbering And Formatting section of the Footnote Options dialog box:

Numbering Style Choose the numbering style for footnote reference numbers.

Start At Specify the number used for the first footnote in the story. Each story in a document begins with the same Start At number. If you have multiple documents in a book with continued page numbering, you may want to start the footnote numbering in each chapter to continue where the last chapter left off.

The Start At option is especially useful for documents in a book. Footnote numbering is not continued across documents in a book.

Restart Numbering Every If you want numbering to restart within the document, select this option and choose Page, Spread, or Section to determine when footnote numbering is restarted. Some numbering styles, such as asterisks (*), work best when reset every page.

Show Prefix/Suffix In Select this option to show prefixes or suffixes in the footnote reference, the footnote text, or both. Prefixes appear before the number (such as [1]) and suffixes appear after the number (such as 1]). This option is especially useful for placing footnotes within characters, such as [1]. Type a character or characters or select an option for Prefix, Suffix, or both. To select special characters, click the icons next to the Prefix and Suffix controls to display a menu.

 *If you think the footnote reference number is too close to the preceding text, adding one of the space characters as a prefix might improve the appearance. You can also apply a character style to the reference number.*

Position This option determines the appearance of the footnote reference number, which is superscript by default. If you prefer to format the number using a character style (such as a character style that includes OpenType superscript settings), choose Apply Normal, and specify the character style.

Character Style You may want to choose a character style to format the footnote reference number. For example, instead of using superscript, you might want to use a character style at a normal position with an elevated baseline. The menu displays the character styles available in the Character Styles panel.

Paragraph Style You may want to choose a paragraph style that formats the footnote text for all footnotes in the document. The menu displays the paragraph styles available in the Paragraph Styles panel. By default, the [Basic Paragraph] style is used. Note that the [Basic Paragraph] style may not have the same appearance as the default font settings for the document.

Separator The separator determines the white space that appears between the footnote number and the start of the footnote text. To change the separator, first select or delete the existing separator, and then choose a new separator. You can include multiple characters. To insert white space characters, use the appropriate metacharacter, such as ^m for em space.

Footnote layout options

The following options appear in the Layout section of the Footnote Options dialog box:

Minimum Space Before First Footnote This option determines the minimum amount of space between the bottom of the column and the first footnote line. You cannot use a negative value. Any Space Before setting in the footnote paragraph is ignored.

Space Between Footnotes This option determines the distance between the last paragraph of one footnote and the first paragraph of the next footnote in a column. You cannot use a negative value. The Space Before/Space After values in a footnote's paragraph apply only if the footnote includes multiple paragraphs.

First Baseline Offset This option determines the distance between the start of the footnote area (where the footnote divider appears by default) and the first line of footnote text.

For information on the First Baseline options, see Change text frame properties.

Place End Of Story Footnotes At Bottom Of Text Select this option if you want the last column's footnotes to appear just below the text in the last frame of the story. If this option is not selected, any footnote in the last frame of the story appears at the bottom of the column.

Allow Split Footnotes Select this option if you want footnotes to break across a column when the footnote exceeds the amount of space available for it in that column. If splitting is not allowed, the line containing the footnote reference number moves to the next column, or the text becomes overset.

 If *Allow Split Footnotes* is turned on, you can still prevent an individual footnote from splitting by placing the insertion point in the footnote text, choosing *Keep Options* from the Paragraph panel menu, and selecting the *Keep Lines Together* and *All Lines In Paragraph* options. If the footnote contains multiple paragraphs, use the *Keep With Next X Lines* option in the first paragraph of the footnote text. You can choose *Type > Insert Break Character > Column Break* to control where the footnote is split.

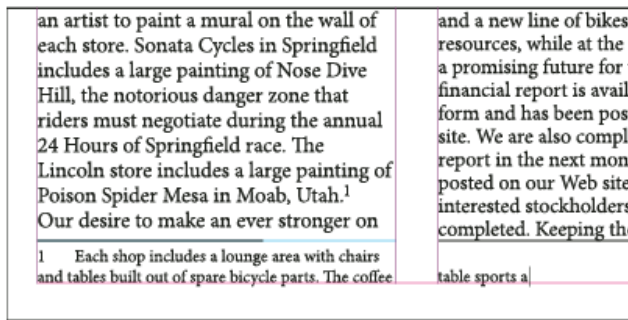

Footnote split across column.

Rule Above Specify the location and appearance of the footnote divider line that appears above the footnote text. A divider line (also called a "separator line") also appears above any footnote text continued in a separate frame. The options you select apply to either the First Footnote In Column or Continued Footnotes, whichever is selected in the menu. These options are similar to those that appear when you specify a paragraph rule. If you want to remove the footnote divider line, deselect Rule On.

[To the top](#)

Delete footnotes

- To delete a footnote, select the footnote reference number that appears in text, and then press Backspace or Delete. If you delete only the footnote text, the footnote reference number and footnote structure remain.

[To the top](#)

Work with footnote text

As you edit footnote text, note the following:

- When the insertion point is in footnote text, choosing Edit > Select All selects all the footnote text for that footnote, but no other footnote or text.

- Use the arrow keys to navigate among footnotes.
- Footnote numbering is not continued across documents in a book. If you don't want numbering to restart in each document with the book, you need to change the Start At value manually in each document after the editing is final.
- In Story Editor, you can click the footnote icon to expand or collapse a footnote. You can expand or collapse all footnotes by choosing View > Story Editor > Expand All Footnotes or Collapse AllFootnotes.
- You can select and apply character and paragraph formatting to footnote text. You can also select and change the appearance of the footnote reference number, but the recommended method is using the Document Footnote Options dialog box.
- When you cut or copy text that includes the footnote reference number, the footnote text is also added to the clipboard. If you copy the text to a different document, the footnotes in that text use the characteristics of the new document's numbering and layout appearance.
- If you accidentally delete the footnote number at the start of the footnote text, you can add it back by placing the insertion point at the beginning of the footnote text, right-clicking (Windows) or Control-clicking (Mac OS), and choosing Insert Special Character > Markers > Footnote Number.
- Text wrap has no effect on footnote text.
- If you clear overrides and character styles on a paragraph that includes a footnote reference marker, the footnote reference numbers lose the attributes you applied in the Document Footnote Options dialog box.

Adobe also recommends

 Twitter™ and Facebook posts are not covered under the terms of Creative Commons.

[Legal Notices](#) | [Online Privacy Policy](#)

Creating book files

- [Create a book file](#)
- [Add documents to a book file](#)
- [Manage book files](#)
- [Synchronize book documents](#)
- [Convert book files from previous InDesign versions](#)
- [Number pages, chapters, and paragraphs in a book](#)
- [Print or output a book file](#)

[To the top](#)

Create a book file

A *book file* is a collection of documents that can share styles, swatches, master pages, and other items. You can sequentially number pages in booked documents, print selected documents in a book, or export them to PDF. One document can belong to multiple book files.

One of the documents added to a book file is the *style source*. By default, the style source is the first document in the book, but you can select a new style source at any time. When you *synchronize* documents in a book, the specified styles and swatches from the style source replace those in other booked documents.

Michael Murphy provides a video tutorial about creating books at [Book Basics](#).

1. Choose File > New > Book.
2. Type a name for the book, specify a location, and then click Save.

The Book panel appears. The book file is saved with the file name extension .indb.

3. Add documents to the book file.

[To the top](#)

Add documents to a book file

When you create a book file, it opens in the Book panel. The Book panel is the working area of a book file, where you add, remove, or rearrange documents.

1. Choose Add Document in the Book panel menu, or click the plus button  at the bottom of the Book panel.
2. Select the Adobe InDesign document or documents you want to add, and then click Open.

 You can drag and drop files onto the Book panel from an Explorer (Windows) or Finder (Mac OS) window. You can also drag a document from one book to another. Hold down Alt (Windows) or Option (Mac OS) to copy the document.

3. If you included documents created in earlier versions of InDesign, they will be converted to Adobe InDesign CS5 format when added to the book. In the Save As dialog box, specify a new name for the converted document (or leave the name as is), and then click Save.

Note: You must convert Adobe PageMaker or QuarkXPress documents before adding them to the book file.

4. If necessary, change the order of the documents in the panel by dragging them up or down to the appropriate locations in the list.





5. To designate a document as the style source, click the box next to the document's name in the panel.

To open a document in a book file, double-click the document name in the Book panel.

[To the top](#)

Manage book files

Each open book file appears on its own tab in the Book panel. If multiple books are open at the same time, click a tab to bring that book to the front and access its panel menu.

Icons in the Book panel indicate a document's current status, such as open , missing  (the document was moved, renamed, or deleted), modified  (the document was edited or its page or section numbers changed while the book was closed), or in use  (if someone else has the document open in a managed workflow). No icon appears next to closed documents.

 *To view the pathname of any document in a book, hold the mouse pointer over the document name until a tooltip appears. Or, choose Document Information from the Book panel menu.*

Save a book file

Book files are separate from document files. For example, when you choose the Save Book command, InDesign saves the changes to the book, not the documents in the book.

- Do one of the following:
 - To save a book under a new name, choose Save Book As in the Book panel menu, specify a location and filename, and click Save.
 - To save an existing book under the same name, choose Save Book in the Book panel menu, or click the Save button  at the bottom of the Book panel.

Note: *If you are sharing book files over a server, make sure that you have a file management system in place so that you don't save over each other's changes accidentally.*

Close a book file

- To close a single book, choose Close Book in the book's panel menu.
- To close all open books docked together in the same panel, click the close button on the Book panel's title bar.

Remove book documents

1. Select the document in the Book panel.
2. Choose Remove Document in the Book panel menu.

Removing the document from the book file doesn't delete the file on disk; the document is removed only from the book file.

Replace book documents

1. Select the document in the Book panel.
2. Choose Replace Document in the Book panel menu, locate the document you want to replace it with, and then click Open.

Open a book file in Explorer or Finder

1. In the books panel, select a document.
2. From the books panel menu, choose Reveal In Explorer (Windows) or Reveal In Finder (Mac OS).

A browser window opens that displays the selected file.

[To the top](#)

Synchronize book documents

When you synchronize documents in a book, the items you specify—styles, variables, master pages, trap presets, cross-reference formats, conditional text settings, numbered lists, and swatches—are copied from the style source to the specified documents in the book, replacing any items that have identical names.

If items in the style source are not found in the documents being synchronized, they are added. Items that are not included in the style source are left as is in the documents being synchronized.

Select items to synchronize

1. Choose Synchronize Options in the Book panel menu.
2. Select the items you want to copy from the style source to other book documents.

Be sure to select all styles included in the definition of other styles. For example, an object style may contain paragraph and character styles, which in turn include swatches.

3. Select Smart Match Style Groups to avoid duplicating uniquely named styles that have been moved into or out of style groups.

Suppose the style source includes a character style in a style group, and the documents being synchronized include this same character style outside the style group. If this option is selected, the character style is moved into the style group in synchronized documents.

If this option is not selected, a second instance of the character style is created in the style group with options that match the style source. The character style outside the style group does not change.

Note: *If a document contains multiple styles that have the same name (for example, Character Style 1 in a style group and Character Style 1 outside of a style group), InDesign behaves as if the option is not selected. For best results, create styles with unique names.*

4. Click OK.

Synchronize documents in a book file

You can synchronize the book while documents in the book are closed. InDesign opens the closed documents, makes any changes, and then saves and closes the documents. Documents that are open when you synchronize are changed but not saved.

1. In the Book panel, click the blank box next to the document that you want to be the style source; the style source icon  indicates which document is the style source.

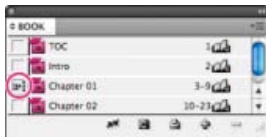

Selected style source

2. Make sure that the items you want copied from the style source are selected in the Synchronize Options dialog box.
3. In the Book panel, select the documents you want to synchronize with the style source document. If no document is selected, the entire book will be synchronized.

 To make sure that no documents are selected, click the blank gray area below the booked documents—you may need to scroll or resize the Book panel. You can also hold down **Ctrl** (Windows) or **Command** (Mac OS) and click a selected document to deselect it.

4. Choose Synchronize Selected Documents or Synchronize Book from the Book panel menu, or click the Synchronize button  at the bottom of the Book panel.

Note: Choosing **Edit > Undo** will undo changes only in documents that are open at the time synchronization occurs.

Synchronizing master pages

Master pages are synchronized in the same way as other items—master pages with the same name (such as A-Master) as those in the style source are replaced. Synchronizing masters is useful for documents that use the same design elements, such as running headers and footers. However, if you want to preserve page items on a master page in documents other than the style source, either don't synchronize master pages or create master pages with different names.

Any master page items that are overridden on document pages after you synchronize masters for the first time are detached from the master. Therefore, if you plan on synchronizing master pages in your book, it's a good idea to synchronize all the documents in your book at the start of the design process. That way, overridden master page items will maintain their connection to the master page and will continue to be updated from modified master page items in the style source.

It's also a good idea to synchronize master pages using only one style source. If you synchronize from a different style source, overridden master page items may become detached from the master page. If you need to synchronize using a different style source, deselect the Master Pages option in the Synchronize Options dialog box before doing so.

[To the top](#)

Convert book files from previous InDesign versions

You can convert a book file created in a previous version of InDesign by opening and saving it in InDesign CS5. When you synchronize, update numbering, print, package, or export a converted book, the documents it contains are also converted to InDesign CS5 format. You can decide whether you want to overwrite or keep the original document files.

Convert a book file for use with InDesign CS5

1. In InDesign CS5, choose **File > Open**.
2. Select the book file created in a previous version of InDesign and click **OK**.

A warning appears if the book file contains documents saved in a previous InDesign format.

3. Choose **Save Book As** from the Book panel menu. Specify a new name for the converted book file, and click **Save**.

Convert documents in a book file

1. Open the book file in InDesign CS5.
2. In the Book panel menu:
 - If you want the original documents to be overwritten during conversion, select Automatic Document Conversion.
 - If you want to keep the original documents and save the converted documents with new names, deselect Automatic Document Conversion. (The book list will be updated to include the converted files, not the originals.)
3. Do any of the following to convert the documents:
 - Choose Synchronize Book from the Book panel menu. (See [Synchronize book documents.](#))
 - Choose Update Numbering > Update All Numbers from the Book panel menu.
4. If Automatic Document Conversion is not selected, InDesign prompts you to save each converted document with a new name.

Note: Documents are also converted when you print or export the book to Adobe PDF.

[To the top](#)

Number pages, chapters, and paragraphs in a book

You can determine how pages, chapters, and paragraphs are numbered in a book. In a book file, the numbering styles and starting numbers for pages and chapters are determined by each document's settings in the Numbering & Section Options dialog box or the Document Numbering Options dialog box. You can open one of these dialog boxes by choosing Layout > Numbering & Section Options in the document or by choosing Document Numbering Options in the Book panel menu.

For information on adding page numbering to a document, see [Add basic page numbering](#).

For numbered paragraphs (such as lists of figures), numbering is determined by the numbered list style definition contained by the paragraph style.

The page range appears beside each document name in the Book panel. By default, InDesign updates page and section numbering in the Book panel when you add or remove pages in booked documents, or when you make changes to the book file, such as reordering, adding, or removing documents. If you turn off the setting to automatically update page and section numbers, you can update numbering in a book manually.

If the book is updated and the numbering seems incorrect, the problem may be that absolute numbers are displayed instead of section numbers in General preferences. See [Display absolute or section numbering in the Pages panel](#).

If a document is missing or cannot be opened, the page range is shown as "?" from the place where the missing document should be to the end of the book, indicating that the true page range is unknown. Remove or replace the missing document before you update numbering. If the In Use icon  appears, someone using a different computer has opened the document in a managed workflow; the person must close the document before you can update numbering.

Change page and chapter numbering options for each document

1. Select the document in the Book panel.
2. Choose Document Numbering Options in the Book panel menu, or double-click the document's page numbers in the Book panel.
3. Specify the page, section, and chapter numbering options. (See [Document numbering options.](#))
4. Click OK.

Note: If you specify a starting page number in a booked document instead of selecting Automatic Page Numbering, the booked document will begin on the specified page; all subsequent documents in the book will be renumbered accordingly.

Start numbering on an odd or even page

You can start document numbering on odd- or even-numbered pages in booked documents.

1. Choose Book Page Numbering Options in the Book panel menu.
2. Choose Continue On Next Odd Page or Continue On Next Even Page.
3. Select Insert Blank Page to add a blank page to the end of any document in which the subsequent document must begin on an odd- or even-numbered page, and then click OK.

Turn off automatic page numbering in a book

1. Choose Book Page Numbering Options from the Book panel menu.
2. Deselect Automatically Update Page & Section Numbers, and then click OK.
3. To update page numbering manually, choose Update Numbering > Update All Numbers in the Book panel menu.

You can also update only page and section numbers or only chapter and paragraph numbers.

Use sequential paragraph numbering in books

To use sequential paragraph numbering for lists of figures, tables, or other items, you first define a numbered list that is used in a paragraph style. The numbered list you define determines whether paragraph numbering maintains sequential numbering across documents in a book.

1. Open the document that is used as the style source for the book.
2. Choose Type > Bulleted And Numbered Lists > Define Lists.
3. Click New to define a list or select an existing list and choose Edit.
4. Select both Continue Numbers Across Stories and Continue Numbers From Previous Document In Book.
5. Click OK.
6. Define a paragraph style that uses a numbered list, and apply it to the text in each document that contains the list. (See Create a paragraph style for running lists.)

 *To make sure the same numbered list setting is used across all documents in the book, select the Paragraph Styles and Numbered Lists options in the Synchronize Options dialog box, and then synchronize the book.*

[To the top](#)

Print or output a book file

One advantage of using a book file is that you can use a single command to output—for print, preflight, package, or export to EPUB or PDF—selected booked documents or the entire book.

1. In the Book panel, do one of the following:

- To output specific documents, select the desired documents.
- To output the entire book, make sure no documents are selected.

2. Choose an output command (such as Print Book or Print Selected Documents) in the Book panel menu.

Adobe also recommends

- Add basic page numbering
- Export to PDF for printing

 Twitter™ and Facebook posts are not covered under the terms of Creative Commons.

[Legal Notices](#) | [Online Privacy Policy](#)

Creating an index

- [About indexing](#)
- [Index panel overview](#)
- [Create a list of topics for an index](#)
- [Add index entries](#)
- [Page range options in indexes](#)
- [Add “See” or “See also” cross-references to an index](#)
- [Generate an index](#)
- [Change the sort order of indexes](#)
- [Manage an index](#)

[To the top](#)

About indexing

You can create a simple keyword index or a comprehensive, detailed guide to the information in your book. You can create only one index for a document or book. To create an index, you first place index markers in the text. You associate each index marker with the word, called a *topic*, that you want to appear in the index.

When you generate the index, each topic is listed, along with the page on which it was found. The topics are sorted alphabetically, typically under section headings (A, B, C, and so on). An index entry consists of a topic (the term readers look up) paired with either a page reference (page number or range) or a cross-reference. A cross-reference, preceded by “See” or “See also,” points the reader to other entries in the index, rather than to a page number.

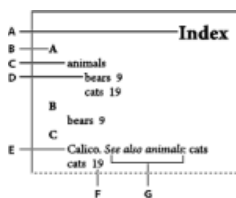

Parts of an index

A. Title **B.** Section heading **C.** Index entry **D.** Subentry **E.** Topic **F.** Page reference **G.** Cross-reference

Tips for creating an index

Creating a well-planned and complete index can help make the information in your document immediately accessible to your readers. Here are a few guidelines to consider:

- Think about how you want your index to look. How many topic levels will it have? Will it refer the reader to other related topics? Will a simple keyword index suffice, or do you want a more complex index with cross-references to related topics and a well-researched list of equivalent terms?
- Anticipate the variety of ways by which your readers might look up information. For instance, one reader may search for information on animals by looking under *beasts*; another may look for *wildlife* or *fauna*.
- Add index entries when the content of your document is fairly stable. If you delete large portions of your text later, you may lose some of your indexing work.
- A well-planned index presents topics consistently. Common indexing problems include mixing uppercase and lowercase (*cats* and *Cats*) and singular and plural forms (*cat* and *cats*). Use a topic list to keep terms consistent.
- Review your index several times before you generate the final index. Look for duplicate entries, weak subject areas, misspellings, and inconsistencies in capitalization and wording; for example, InDesign treats *Cheetah*, *cheetah*, and *cheetahs* as separate entries.

Workflow for creating an index

To create an index, follow these basic steps:

- 1. Create a topic list (optional)** A topic list helps you maintain consistency in your index entries. (See [Create a list of topics for an index.](#))
- 2. Add index markers.** Add index markers on the pages in your document that you want the index entries to refer to. (See [Add index entries.](#))
- 3. Generate the index.** Generating the index creates a set of entries for markers and their accompanying page numbers. (See [Generate an index.](#))
- 4. Flow the index story.** Use the loaded text cursor to flow the index into a text frame. In most cases, you'll want the index to start on a new page. After you flow the index, you can format the pages and index.
You'll likely repeat these steps several times as you refine your index prior to publication.

[To the top](#)

Index panel overview

You create, edit, and preview the index using the Index panel (Window > Type & Tables > Index). The panel includes two modes: Reference and Topic. In Reference mode, the preview area displays complete index entries for the current document or book. In Topic mode, the preview area displays only topics, not page numbers or cross-references. Topic mode is used primarily for creating the index structure, whereas Reference mode is where you add your index entries.

In Reference mode, index entries are alphabetized and divided into sections by letter. Triangles next to entries let you expand or collapse the entry to view subentries, page numbers, and cross-references.

The following codes appear in place of page references to indicate index entries that may not be included in the generated index. You may need to choose Update Preview in the Index panel to view the codes.

PB Indicates index entries on the pasteboard. These entries will not appear in the generated index.

HL Indicates index entries on a hidden layer. When you generate the index, you have the option of including index entries on a hidden layer.

HT Indicates index entries in a hidden condition. Index entries in hidden conditions are not included in the index.

PN Indicates index entries in overset text. When you include these entries in the generated index, they appear without page numbers.

Master Indicates index entries on a master page. These entries will not appear in the generated index.

Click a triangle to expand or collapse an individual entry. Alt-click (Windows) or Option-click (Mac OS) a triangle to expand or collapse all subentries under an entry. Ctrl-click (Windows) or Command-click (Mac OS) a triangle to expand or collapse all entries.

 *Choose Update Preview in the Index panel menu to update the preview area. This option is especially useful if you've edited your document extensively or moved index markers in the document window.*

[To the top](#)

Create a list of topics for an index

You can create or import a list of topics to use as a starting point when creating index entries. Later, when you add entries to the index, you can select topics from the topic list (instead of typing them each time) to ensure that information is indexed consistently throughout your document or book.

You create and edit a topic list using the Index panel in Topic mode. Note that Topic mode displays topics only; to preview index entries, with their

associated page numbers and cross-references, use Reference mode instead.

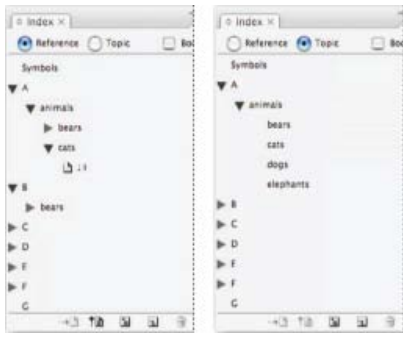

Index panel in Reference mode (left) and Topic mode (right)

Topics in the topic list appear in the New Page Reference dialog box as well. To create an index entry, simply select a topic and then associate it with a page or cross-reference. Unused topics (those without page or cross-references) are excluded when you generate an index.

Creating a topic list before you add index entries is optional. Each time you create an index entry, its topic is automatically added to the topic list for future use.

 By default, topics you add to the Topics list do not appear in the Reference list, which displays only the topics that have been associated with a page. However, to display the topics in the Reference list, you can choose Show Unused Topics from the Index panel menu in Reference mode.

Add topics to the topics list

1. Choose Window > Type & Tables > Index to display the Index panel.
2. Select Topic.
3. Choose New Topic from the Index panel menu or click the Create New Index Entry icon at the bottom of the panel.
4. Do one of the following:
 - Under Topic Levels, type the topic name (for example, *animals*) in the first box. To create a subtopic, type a name (*cats*) in the second box. In this example, “cats” is indented under “animals.” To create a subtopic under the subtopic, type a name (*Calicos*) in the third box, and so on.
 - Select an existing topic. Enter subtopics in the second, third, and fourth boxes.
5. Click Add to add the topic, which will now appear in the New Topic dialog box as well as the Index panel.
6. Click Done when you’ve finished adding topics.

 To delete a topic that you’ve just added, click Done, select the topic in the Index panel, and then click the Delete Selected Entry button.

Import topics from another InDesign document

1. Choose Import Topics in the Index panel menu.
2. Select the document containing the index topics you want to import, and then click Open.

Edit an index topic

Use the Index panel to edit entries before or after you generate an index. Changes you make to your entries in the Index panel will appear in the next index that you generate, but changes that you make to the generated index story will be lost when you regenerate the index.

1. Open a document containing the index topics.
2. In the Index panel, select Topic.
3. In the preview area, double-click a topic to edit.
4. Edit the topic as desired, and then click OK.

[To the top](#)

Add index entries

You create index entries using the Index panel in Reference mode. An index entry consists of two parts: a topic and a reference. Topics can be defined ahead of time using a topic list. References can be page numbers or cross-references to other topics.

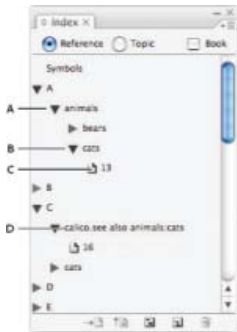

Index panel in Reference mode

A. Entry **B.** Subentry **C.** Page reference **D.** Cross-reference

An index marker is inserted at the beginning of the word in which text is selected or at the insertion point. You can view index markers by choosing Type > Show Hidden Characters.

Add an index entry

1. Using the Type tool , place the insertion point where you want the index marker to appear, or select text in the document to use as the basis for an index reference.

When selected text contains inline graphics or special characters, some characters (such as index markers and inline graphics) are stripped out in the Topic Level box. Other characters, such as em dashes and copyright symbols, are converted to metacharacters (for example, ^_ or ^2).

2. Choose Window > Type & Tables > Index to display the Index panel.
3. Select Reference.



If entries added to the Topic list do not appear in the Reference, choose Show Unused Topics from the Index panel menu. You can then use those topics when adding entries.

4. To view index entries from any open documents in a book file, select Book.
5. Choose New Page Reference in the Index panel menu. (If this command does not appear, make sure Reference is selected and that there is an insertion point or text selection in the document.)
6. To add text to the Topic Levels box, do any of the following:
 - To create a simple index entry (such as *cats*), type the entry in the first Topic Levels box. (If text was selected, that text appears in the Topic Levels box.)
 - To create entries and subentries, type the parent name (for this example, *animals*) in the first Topic Levels box, and type subentries (*cats* and *Calicos*) in subsequent boxes. If necessary, click the up and down arrows to change places with the item above or below the selected item.

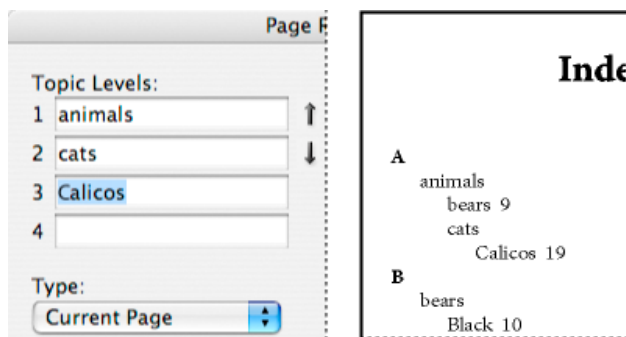

Index entry in the Topic Levels box (left) and resulting appearance in the Index (right)

- Double-click any topic in the list box at the bottom of the dialog box.
7. To change the way an entry is sorted in the final index, use the Sort By boxes. For example, to sort the topic *de la Vega* under V (instead of D), you would type *Vega* in the Sort By box and *de la Vega* in the Topic Level box.

You can also select the sort order of numbers, symbols, and languages, and you can edit sort information for Chinese characters. (See [Change the sort order of indexes.](#))

8. Specify the type of index entry:
 - To create index entries that have a page number or range (such as *cats 82–87*), choose an option that describes the span of the entry in the Type pop-up menu. (See [Page range options in indexes.](#))
 - To create an index entry without a page number, choose Suppress Page Range in the Type menu. Although no page number will appear in the generated index, the page number appears in parentheses in the Index panel.
 - To create an index entry which refers to another entry, select one of the cross-reference options (such as *See* or *See also*) from the Type pop-up menu, and input the entry name in the Referenced text box, or drag the existing entry from the list at the bottom to the Referenced box. You can also customize the See and See also terms displayed in the cross-reference entries by selecting Custom Cross Reference from the Type pop-up menu. (See [Add “See” or “See also” cross-references to an index.](#))
9. To add emphasis to a particular index entry, select Number Style Override, and then specify a character style.
10. To add an entry to the index, do any of the following:
 - Click Add to add current entry and leave the dialog box open for additional entries.

Click Add All to locate all instances of the selected text in the document window and create an index marker for each one. Add All is available only if text in the document is selected.

- Click OK to add the index entry and close the dialog box.

Note: If you click Cancel after clicking Add, the entries you just added are not removed. Use the Undo command to remove these entries.

11. To close the dialog box, click OK or Done.

Index a word, phrase, or list quickly

Using an indexing shortcut, you can quickly index individual words, a phrase, or a list of words or phrases. Adobe InDesign recognizes two indexing shortcuts: one for standard index entries; the other for proper names. The proper name shortcut creates index entries by reversing the order of a name so it is alphabetized by the last name. In this way, you can list a name with the first name first, but have it appear in the index sorted by last name. For example, the name *James Paul Carter* would appear in the index as *Carter, James Paul*.

To prepare a list for indexing, separate each item you want to be indexed with any of the following: a return, a soft return (Shift + Return key), a tab, a right-indent tab (Shift + Tab), a semicolon, or a comma. The indexing shortcut adds a marker in front of each entry and places all the items into the index.

1. In the document window, select the word or words you want to index.
2. Do one of the following:
 - For standard words or phrases, press Shift+Alt+Ctrl+[(Windows) or Shift+Option+Command+[(Mac OS).
 - For proper names that you want indexed by the last name, press Shift+Alt+Ctrl+] (Windows) or Shift+Option+Command+] (Mac OS).

An index marker using the default settings is added at the beginning of the selection or to the beginning of each item selected.

 To index compound last names or names with a title, include one or more nonbreaking spaces between the words. For example, if you want to index “James Paul Carter Jr.” by “Carter” instead of “Jr.,” place a nonbreaking space between “Carter” and “Jr.” (To insert a nonbreaking space, choose Type > Insert White Space > Nonbreaking Space.)

When you select terms like kanji for which a yomi is required and set the index marker using a shortcut, the New Page Reference dialog box will open automatically if the yomi has not been input, and the term selected will be displayed in the Topic Levels dialog box. Input the yomi corresponding to the text input in the Topic Levels box in the Yomi text box. When the same index entry appears on several pages, the yomi for all the index entries can be changed in a single step. To change only the index entry selected, select the page number in the Index panel and Page Reference Options from the Index panel menu.

Create a new entry from an existing one

Often, a subject you're indexing appears in multiple places in a document or book. When this happens, you can create multiple index entries based on other entries already in your index to ensure consistency.

1. In the document window, click an insertion point, or select text where the index marker will appear.
2. In the Index panel, select Reference, and scroll the preview area to the entry you want to copy.
3. Do one of the following:
 - Drag an entry to the New Entry button  to insert an index marker at the insertion point, or at the beginning of the selection.
 - Select an entry in the panel preview area, and then hold down Alt (Windows) or Option (Mac OS) and click the New Entry button. The New Page Reference dialog box appears, with information about the selected entry. Make any changes, and then click Add or OK.

Alternatively, you can create a topic list, and then select topics from the list as you create index entries.

Index every occurrence of a word automatically

Using the Add All option is an effective way to index all occurrences of a specified term in a document or a book. When you click Add All, InDesign creates index markers at every occurrence of the words selected in the document—not the text specified in the dialog box. (You can later delete entries that point to less significant information.)

When searching for occurrences of the selected text, InDesign considers only whole words, and searches are case-sensitive. For example, if *cheetah* is selected, *cheetahs* and *Cheetah* will not be indexed.

1. In the document window, select the text you want to search for.
2. In the Index panel, select Reference.
3. To create index entries for any open documents in the book, select Book.
4. Choose New Page Reference in the Index panel menu.
5. Choose Add All. InDesign adds index markers to all text that matches the selected text, regardless of whether the text has been indexed, so you may end up with multiple entries for the same word or phrase.

Edit an index entry

To change a topic (such as renaming it or applying a new sort order) and automatically update all entries that use that topic, use the Index panel in Topic mode. To change one entry at a time, use Reference mode. In Reference mode, you can also add cross-references or locate the index marker associated with a page reference.

1. Open the document containing the index entries.
2. In the Index panel, do one of the following:
 - Select Topic to edit a topic and automatically update all entries using that topic.
 - Select Reference to edit an individual entry.
3. In the preview area, select an entry or page reference. To select a page reference, select the page icon below the entry.
4. Double-click an entry or page reference to edit.
5. Edit the entry, and then click OK.

[To the top](#)

Page range options in indexes

You can create index entries that include a page range (such as *cats 82–87*) instead of a single page number. The Type pop-up menu in the New Page Reference dialog box includes the following page-range options:

Current Page The page range does not extend beyond the current page.

To Next Style Change The page range extends from the index marker to the next change of paragraph style.

To Next Use Of Style The page range extends from the index marker to the page where the next occurrence of the paragraph style specified in the adjacent paragraph style pop-up menu appears.

To End Of Story The page range extends from the index marker to the end of the current thread of text frames that contain text.

To End Of Document The page range extends from the index marker to the end of the document.

To End Of Section The page range extends from the index marker to the end of the current section as defined in the Pages panel. (See Document numbering options.)

For Next # Of Paragraphs The page range extends from the index marker to the end of the number of paragraphs specified in the adjacent box, or to the end of as many paragraphs as exist.

For Next # Of Pages The page range extends from the index marker to the end of the number of pages specified in the adjacent box, or to the end of as many pages as exist.

Suppress Page Range Turn off page range.

[To the top](#)

Add “See” or “See also” cross-references to an index

Cross-references are index entries that point to related entries, instead of a page number. You create cross-references using the Index panel. Cross-references can serve different purposes in an index:

- Cross-references associate common terms with equivalents used in your document or book. For example, *Fauna. See Animals*. Entries with such cross-references do not contain page references; they simply point to equivalent terms that are indexed more fully.
- Cross-references point to other entries related to, but not equivalent to, a topic. For example, *Cats. See also Wildcats*. In this case, the index entry containing the cross-reference also contains page numbers and/or subentries that are directly related to the entry's topic.

Index	
	E
animals	elephants 37
bears 9	eagles 24
	F
Cat Calico 19	fauna 15. See also animals — A
	fish 6 — B
	flora. See plants — C

Two types of cross-references

A. Cross-reference to related information (See also) B. Cross-reference to an equivalent term (See)

When you create a cross-reference in InDesign, you can also select a cross-reference prefix. “See” and “See also” are static text. When you choose “See [also],” InDesign automatically assigns the correct prefix to the cross-reference each time the index is generated:

- Entries with page numbers, subentries, or both are given “See also.”
- Entries without page numbers or subentries are given “See.”

Using the “See [also]” option frees you from the task of manually updating cross-references as the contents of your index entries change.

1. Choose Window > Type & Tables > Index.
2. Select Reference.

3. (Optional) Select Book to view index entries from any open documents in a book file.
4. Choose New Page Reference in the Index panel menu.
5. Enter a topic or topics in the Topic Levels boxes.
6. In the Type menu, choose a cross-reference prefix (such as See also) from the bottom of the menu.
7. Type a topic in the Referenced box, or drag an existing topic from the topic list at the bottom.
8. Click Add to add the cross-reference to the index.

Cross-references appear in the Index panel and the generated index, but are not associated with index markers in the document itself.

Cross-references with “See [also]” appear as “See [also]” in the Index panel; however, the correct prefix will appear in the generated index story.

[To the top](#)

Generate an index

Once you’ve added index entries and previewed them in the Index panel, you’re ready to generate an index story to place in your document for publication.

An index story can appear as a separate document or in an existing document. When you generate an index story, InDesign compiles index entries and updates page numbers across your document or book. If you add or delete index entries or update numbering in your document, however, you’ll need to regenerate the index to update it.

If an index marker appears in overset text when you generate the index, you are asked if you would like to include these markers in the index. If you click Yes, the entry appears in the index without a page number. If an index marker appears in hidden conditional text, the entry is excluded from the index.

1. Do one of the following:
 - If you’re creating an index for a single document, you may want to add a new page at the end of the document.
 - If you’re creating an index for multiple documents in a book, create or open the document to be used for the index, and make sure that it’s included in the book.
2. Choose Generate Index in the Index panel menu. Specify settings for the following options:
 - For Title, type the text that will appear at the top of the index. To determine how the title is formatted, select a style in the Title Style pop-up menu.
 - Select Replace Existing Index to update an existing index. This option is dimmed if you haven’t generated an index. Deselecting this option lets you create multiple indexes.
 - Select Include Book Documents to create a single index for all documents in the current book list and to renumber the book’s pages. Deselect this option if you want to generate an index for the current document only.
 - Select Include Entries On Hidden Layers if you want index markers on hidden layers to be included in your index.
 - To view additional index options, click More Options.
3. Click OK. If Replace Existing Index is deselected, a loaded text icon appears. Place the index story as you would any other text.

 *If you edit entries in the index story, these changes are overridden when you regenerate the index. For best results, edit the index in the Index panel, and then generate the index again.*

Index formatting options

When you click More Options in the Generate Index dialog box, formatting options appear that let you determine the style and appearance of the generated index. InDesign includes a number of built-in paragraph and character styles that you can select to format the generated index, or you can create and select your own styles. After you generate the index, you can edit these styles in the Paragraph Styles and Character Styles panels.

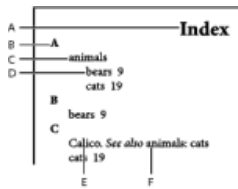

Index with nested entries

A. Title **B.** Section heading **C.** Level 1 entry **D.** Level 2 subentry **E.** Topic **F.** Cross-reference

 To replace the entry separators (such as the values for Following Topic or Between Entries), select the existing separator and then type or choose a replacement character.

Nested or Run-in Select Nested if you want the index formatted in the default style, with subentries nested under an entry as separate indented paragraphs. Select Run-in if you want all levels of an entry to appear in a single paragraph. The Between Entries option determines which character separates the entries.

Include Index Section Headings Select this option to generate section headings consisting of alphabet characters (A, B, C, and so on) representing the section that follows.

Include Empty Index Sections Select this option to generate section headings for all letters of the alphabet, even if the index lacks any first-level entries that begin with a particular letter.

Level Style For each index level, choose a paragraph style to be applied to each level of index entries. You can edit these styles in the Paragraph Styles panel after you generate the index.

Section Heading Select the paragraph style that determines the appearance of the section headings (A, B, C, and so on) in the generated index.

Page Number Select the character style that determines the appearance of the page numbers in the generated index. This setting does not affect index entries you formatted using the Number Style Override option.

Note: If you want the page numbers in the index to include prefixes, as in *B-1* or *II-1*, see [Define section numbering](#).

Cross-reference Select the character style that determines the appearance of cross-reference prefixes (such as *See* and *See also*) in the generated index.

Cross-referenced Topic Select the character style that determines the appearance of the topic being referred to (such as *beasts* in *See also beasts*) in the generated index.

Following Topic Type or select a special character to separate the entry from the page number (such as *Animals 38*). The default is two spaces. Determine formatting for this character by editing the corresponding Level Style, or by selecting another.

Between Page Numbers Type or select a special character to separate one page number or range from another. The default is a comma followed by an en space.

Between Entries If Run-in is selected, type or select a special character to determine how entries and subentries are separated. If Nested is selected, this setting determines how two cross-references under a single entry are to be separated.

Before Cross-reference Type or select a special character that appears between a reference and a cross-reference, as in *Animals*. See also *beasts*. The default is a period followed by a space. Determine formatting for this character by switching or editing the corresponding level style.

Page Range Type or select a special character to separate the first and last numbers in a page range (such as *Animals 38–43*). The default is an en dash. Determine formatting for this character by switching or editing the Page Number style.

Entry End Type or select a special character to appear at the end of entries. If Run-in is selected, the specified character appears at the end of the last cross-reference. The default is no character.

[To the top](#)

Change the sort order of indexes

You can change the sort order of languages and symbols. This is especially useful for Greek, Cyrillic, and Asian languages. It's also useful if you want to change where symbols appear in your index. If you want symbols at the end, you can move the Symbol category to the bottom of the priority list.

Changing the sort order affects the sort order in the Index panel and in the index stories that are generated afterwards. You can create multiple indexes with different sort orders. For example, you can generate an index in German, change the sort order, and then generate a separate index in Swedish — just make sure Replace Existing Index isn't selected when you generate the index.

1. Choose Sort Options from the Index panel menu.
2. Make sure the items you want sorted are selected.
3. To determine the type of language script used, click the item under Header Type and choose a different option from the menu.

For example, for Cyrillic, you can choose Russian, Belarusian, Bulgarian, or Ukrainian. For Chinese, you can choose Pinyin, which is primarily used for Simplified Chinese, or Stroke Count, which is primarily used for Traditional Chinese.

4. To change the order of a language or symbol, select it in the list, and then click the Up or Down buttons in the lower right part of the list.

Items that are higher on the list are sorted before lower items. Any characters from languages that aren't included in the Sort Options dialog box are sorted under symbols. For example, if you have Greek text in your document but don't include Greek under Sort Options, any indexed Greek text will appear under Symbols.

Sort order of Japanese and Korean indexes

When creating index entries for Asian languages, note the following:

- Asian languages use different sorting convention based on their specific typographic rules.
- When making an index for Japanese text, the yomi for index entries in the Topic Level box should be entered in the Yomi box using full-width hiragana and katakana. It is not necessary to input the yomi for full-width hiragana, katakana, alphanumeric characters, some symbols, half-width alphanumeric characters, or index entries that only have symbols in the Yomi box. Entries input in the Topic Level box are sorted. In some cases, when full-width and half-width symbols are mixed in an entry, sorting may not take place as expected. An appropriate, yomi should be entered in these cases.
- Half-width katakana or kanji cannot be input in the Yomi text box. However, full-width symbols, such as ※ and ・, can be input.
- Hiragana and katakana are distinguished and hiragana is sorted before katakana. Upper- and lowercase alphabetic characters are also distinguished, and uppercase characters are sorted before lowercase.
- If the same characters are input in the Topic Level box, they are handled as separate index entries if a different yomi is entered. For example if “Cat” is input as an index entry with a reading of “Neko” in katakana, and then input a second time with a reading of “Neko” in hiragana, two index items for “Cat” will be generated. This feature can also be used to classify the same term under separate index topics. For example,

when entering the term “The Cats” in an index, if “Cats” is input in the Yomi text box and two index entries are created without any input, the term “The Cats” will be generated under the T and C index topics.

- For Korean sort order, you can specify Korean Consonant or Korean Consonant Plus Vowel.

Sort order of Chinese indexes

You determine the sort order of Chinese characters in two places -- in the Sort Options dialog box, and in the Sort By field when you create or edit an index entry.

Sort Options dialog box Choosing Sort Options from the Index panel menu lets you change the sort order and specify whether to use Pinyin or Stroke Count.

Sort By When you're creating or editing an index entry, typing Chinese characters in the Topic Levels fields enables you to edit Chinese sort information.

For Pinyin, if multiple words have the same Pinyin, the order is sorted by (1) tone and (2) stroke count in ascending order. For Stroke Count, each character is sorted by (1) stroke count, (2) first stroke, and (3) second stroke. You can either edit the sort information directly in the Sort By field, or you can click the arrow to the right of the Sort By field to open either the Pinyin Entry dialog box or Stroke Count Entry dialog box. You can edit the fields and click OK. Repeat this process for each topic level.

[To the top](#)

Manage an index

After you set up your index and add index markers to your document, you can manage your index in a variety of ways. You can view all index topics in a book, remove topics from the Topic list that aren't used in the Reference list, find entries in either the Reference or Topics list, and remove index markers from the document.

View all index topics in a book

When the Book option is selected, the Index panel displays entries from the entire book, not just the current document.

1. Open the book file and all of the documents it contains.
2. Select Book at the top of the Index panel.

If others need to access documents in the book while the index is being created, you can create a master list of topics in a separate document, and then import topics from the master list to each document in the book. Note that if the master list changes, you will need to import topics to each document again.

 *When you are indexing a book with multiple documents, you can display the index topics for all the documents listed by generating the book's index, including all the documents. Then you don't have to use Import Topics in the Index menu to manually import the topics into each document.*

Remove unused topics from the Topic list

Once you have created your index, you can delete topics that weren't included in the index.

1. Choose Window > Type & Tables > Index to display the Index panel.
2. Choose Remove Unused Topics in the Index panel menu. All topics that do not have page numbers associated with them are deleted.

Delete index markers

- Do either of the following:
 - In the Index panel, select the entry or topic you want to delete. Click the Delete Selected Entry button .

Note: *If the selected entry is the heading for multiple subheadings, all subheadings are also deleted.*

- In the document window, select the index marker and press Backspace or Delete.

Note: *To view index markers in the document window, choose Type > Show Hidden Characters.*

Find an index entry in the Index panel

1. Choose Show Find Field in the Index panel menu.
2. In the Find box, type the name of the entry you want to locate, and then click the Up Arrow or Down Arrow.

Locate index markers in a document

1. Choose Type > Show Hidden Characters to display index markers in the document window.
2. In the Index panel, click Reference, and then select the entry you want to locate.
3. Choose Go To Selected Marker in the Index panel menu. The insertion point appears to the right of the index marker. You can then press Shift+Left Arrow to select the marker for cutting, copying, or deleting.

Capitalize index entries

The Capitalize dialog box provides a global solution for editing the capitalization of index entries so that you don't have to edit entries one by one. For example, if you've indexed some of your entries as lowercase (*cats*) and others as uppercase (*Cats*), these entries will be considered separate topics. You can fix this problem by capitalizing selected entries.

1. In the preview area of the Index panel, select an entry.
2. Choose Capitalize in the Index panel menu.
3. Select whether you want to capitalize only the selected topic, the selected topic and all subtopics, all Level 1 topics, or all topics, and then click OK.

Adobe also recommends

 Twitter™ and Facebook posts are not covered under the terms of Creative Commons.

[Legal Notices](#) | [Online Privacy Policy](#)

Creating a table of contents

[About tables of contents](#)

[Creating tables of contents in books](#)

[Generate a table of contents](#)

[Create TOC styles for multiple lists](#)

[Options for formatting a table of contents](#)

[Create TOC entries with tab leaders](#)

[Create a paragraph style with a tab leader](#)

[Update and edit a table of contents](#)

[To the top](#)

About tables of contents

A table of contents (TOC) can list the contents of a book, magazine, or other publication; display a list of illustrations, advertisers, or photo credits; or include other information to help readers find information in a document or book file. One document may contain multiple tables of contents—for example, a list of chapters and a list of illustrations.

Each table of contents is a separate story consisting of a heading and a list of entries sorted either by page number or alphabetically. Entries, including page numbers, are pulled directly from content in your document and can be updated at any time—even across multiple documents in a book file.

The process for creating a table of contents requires three main steps. First, create and apply the paragraph styles you'll use as the basis for the TOC. Second, specify which styles are used in the TOC and how the TOC is formatted. Third, flow the TOC into your document.

Table of contents entries can be automatically added to the Bookmarks panel for use in documents exported as Adobe PDF.

Tips for planning a table of contents

Consider the following when planning a table of contents:

- Some tables of contents are built from content that does not actually appear in the published document, such as a list of advertisers in a magazine. To do this in InDesign, enter content on a hidden layer and include it when generating a TOC.
- You can load TOC styles from other documents or books to build new tables of contents with the same settings and formatting. (You might need to edit an imported TOC style if the names of paragraph styles in the document do not match those in the source document.)
- You can create paragraph styles for the table of contents' title and entries, including tab stops and leaders, if desired. You can then apply these paragraph styles when you generate the table of contents.
- You can create character styles to format the page numbers and the characters separating them from the entries. For example, if you want the page numbers to be in bold, create a character style that includes the bold attribute, and then select that character style when you create the table of contents.

[To the top](#)

Creating tables of contents in books

For best results, be sure to do the following before creating a table of contents for a book:

- Before you create a table of contents, verify that the book list is complete, that all documents are listed in the correct order, and that all headings have been formatted with the appropriate paragraph styles.
- Be sure to use paragraph styles consistently throughout the book. Avoid creating documents with styles that have identical names but different definitions. If multiple styles have the same name but different style definitions, InDesign uses the style definition in the current document (if a definition exists there), or the first occurrence of the style in the book.

- If the necessary styles do not appear in the pop-up menus in the Table of Contents dialog box, you may need to synchronize the book so that the styles are copied to the document containing the table of contents.
- If you want number prefixes (such as 1-1, 1-3, and so on) to appear in your table of contents, use section numbering rather than chapter numbering. Section number prefixes can be included in a table of contents.

Generate a table of contents

Before you generate a table of contents, decide which paragraphs should be included (such as chapter titles and section headings), and then define paragraph styles for each. Make sure that these styles are applied to all appropriate paragraphs in the document or booked documents.

When you generate the table of contents, you can also use paragraph and character styles to format the table of contents.

Table of Contents		Table of Contents	
Introduction	1	Introduction	1
Chapter 1		Chapter 1	
Mammals	3	Mammals	3
Bears	3	Bears	3
Cats	8	Cats	8
Dogs	10	Dogs	10
Chapter 2		Chapter 2	
Birds	27	Birds	27
Parrots	29	Parrots	29
Chapter 3		Chapter 3	
Reptiles	32	Reptiles	32
Lizards	33	Lizards	33

Table of contents without paragraph styles (left) and with paragraph styles applied to entries (right)

If paragraphs that are to be included in the table of contents appear in different stories on the same page, their order in the TOC is determined by their position on the page.

1. Do one of the following:

- If you're creating a table of contents for a single document, you may want to add a new page at the beginning of the document.
- If you're creating a table of contents for multiple documents in a book, create or open the document to be used for the table of contents, make sure that it's included in the book, and then open the book file.

2. Choose Layout > Table Of Contents.

If you've defined a TOC style that has the appropriate settings for your TOC, you can choose it from the TOC Style menu.

3. In the Title box, type a title for your TOC (such as *Contents* or *List of Figures*). This title will appear at the top of the table of contents. To format the title, choose a style from the Style menu.
4. Select Include Book Documents to create a single table of contents for all documents in the book list, and to renumber the book's pages. Deselect this option if you want to generate a table of contents for the current document only. (This option is dimmed if the current document is not part of a book file.)
5. Determine which content you want to include in the table of contents by double-clicking paragraph styles in the Other Styles list to add them to the Include Paragraph Styles list.
6. Select Replace Existing Table Of Contents to replace all existing table of contents stories in the document. Deselect this option if you want to generate a new table of contents, such as a list of figures.
7. Specify options to determine how each paragraph style in the table of contents is formatted. (See [Options for formatting a table of contents.](#))

 *It's a good idea to define a TOC style that contains the formatting and other options for your table of contents, especially if you want to include multiple TOCs in your document. To do so, click Save Style. You can also create TOC styles by choosing Layout > Table Of Contents Styles.*

8. Click OK.

A loaded text cursor  appears. Before you click or drag, you can move to a different page or create a new page without losing the loaded text.

9. Click or drag the loaded text cursor on a page to place the new table of contents story.

Note: Avoid threading the TOC frame to other text frames in the document. If you replace the existing TOC, the entire story will be replaced by the updated TOC.

[To the top](#)

Create TOC styles for multiple lists

Use TOC styles if you need to create different tables of contents in your document or book. For example, you can use one TOC style for a list of contents and another for a list of advertisers, illustrations, or photo credits. Create a TOC style for each type of list.

Creating TOC styles are also useful if you want to use the same TOC formatting in another document.

Note: Don't confuse TOC styles with paragraph styles that have a "TOC" prefix. TOC-prefixed paragraph styles (for example "TOC title") are used to format the table of contents entries themselves. In contrast, a TOC style is a collection of settings used to automatically create a table of contents.

Create a TOC style

1. Choose Layout > Table Of Contents Styles.
2. Click New.
3. Type a name for the TOC style you are creating.
4. In the Title box, type a title for your TOC (such as *Contents* or *List of Figures*). This title will appear at the top of the table of contents. To specify a title style, choose a style from the Style menu.
5. From the Other Styles list, select the paragraph styles that represent content you want to include in the table of contents, then click Add to add them to the Include Paragraph Styles list.
6. Specify options to determine how each paragraph style is formatted. (See [Options for formatting a table of contents.](#))

Import TOC styles from another document

1. Choose Layout > Table Of Contents Styles.
2. Click Load, select the InDesign file containing the TOC styles you want to copy, and then click Open.
3. Click OK.

Note: If the paragraph styles in your document do not match the paragraph styles in the TOC style you import, you'll need to edit the TOC style before generating a table of contents.

[To the top](#)

Options for formatting a table of contents

When generating or editing a table of contents, use these options to determine the appearance of the generated table of contents text. Some of these options are available only when you click More Options in the dialog box.

Note: The settings in the Style section apply only to the style currently selected under Include Paragraph Styles. You can specify different formatting options for each style.

Entry Style For each style in Include Paragraph Styles, choose a paragraph style to apply to the associated table of contents entries.

Page Number You might want to create a character style that formats the page number. You can then select this style in the Style pop-up list to the right of Page Number. (See Add paragraph and character styles.)

If you want the page numbers of the TOC to include prefixes, or to use a different numbering convention, see Define section numbering.

Between Entry And Number Specify which characters you want between the table of contents entry and its page number. The default is ^t, which tells InDesign to insert a tab. You can choose other special characters, such as Right Indent Tab or Em Space, in the pop-up list. For a complete list of special characters and how to work with them, see [Insert glyphs and special characters](#).

 Select the existing text in the box before you choose a different special character, to make sure that you don't include both characters.

You might want to create a character style that formats the space between the entry and the page number. You can then select this style in the Style pop-up list to the right of Between Entry And Number. (See Add paragraph and character styles.)

If the entry's paragraph style includes a tab leader setting, and if the tab character (^t) is selected, a tab leader appears in the generated table of contents. For more information, see [Create TOC entries with tab leaders](#).

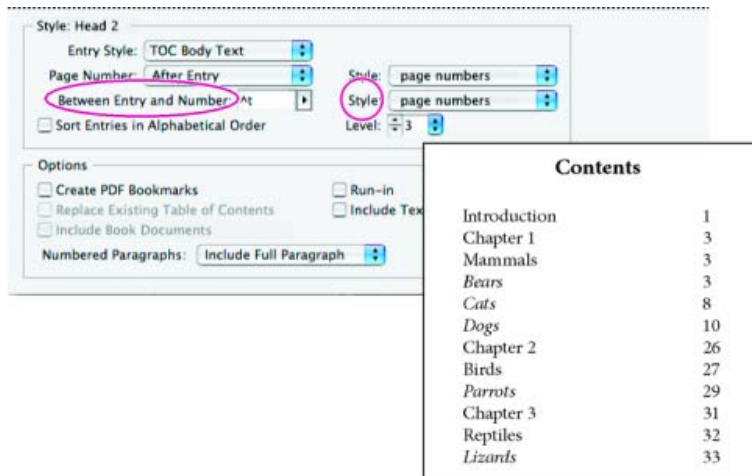

You can specify a character that separates an entry and page number, as well as a style to apply to a character.

Sort Entries in Alphabetical Order Select this option to sort table of contents entries in the selected style alphabetically. This option is useful for creating simple lists, such as lists of advertisers. Nested entries (Level 2 or 3) sort alphabetically within their group (Level 1 or 2, respectively).

Note: The sort order for a table of contents is determined by the document's default language setting. To change the default language setting, make sure nothing is selected and then choose a language from the Language menu in the Character panel.

Level By default, each item added to the Include Paragraph Styles box is set one level lower than the item immediately above it. You can change this hierarchy by specifying a new level number for the selected paragraph style. This option adjusts only the display in the dialog box. It has no effect on the final table of contents unless the list is alphabetized, in which case the entries are sorted by level.

Create PDF Bookmarks Select this option if you want the table of contents entries to appear in the Bookmarks panel of Adobe Acrobat or Adobe Reader® when the document is exported to PDF.

Run-in Select this option if you want all TOC entries to be run into a single paragraph. A semicolon followed by a space (;) separates the entries.

Include Text On Hidden Layers Select this option only if you want the paragraphs on hidden layers to be included in your table of contents. This

is useful when creating a list of advertisers or illustrations that may not appear as visible text in the document itself. Deselect this option when you've used layers to store various versions or translations of the same text.

Numbered Paragraphs If your table of contents includes a paragraph style that uses numbering, specify whether the TOC entry includes the full paragraph (both number and text), only the numbers, or only the paragraph.

Frame Orientation Specify the writing direction for the text frame you will use to create a table of contents.

[To the top](#)

Create TOC entries with tab leaders

Entries in a table of contents are often formatted with dots or tab leaders separating the entry from its associated page number.

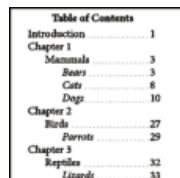

Table of Contents	
Introduction	1
Chapter 1	
Mammals	3
Beats	3
Cats	8
Dogs	10
Chapter 2	
Birds	27
Parrots	29
Chapter 3	
Reptiles	32
Lizards	33

Table of contents with dot leaders

1. Create a paragraph style with a tab leader. (See [Create a paragraph style with a tab leader.](#))
2. To update the table of contents settings, do one of the following:
 - Choose Layout > Table Of Contents Style. Select a TOC style, and click Edit.
 - Choose Layout > Table Of Contents (if you are not using a TOC style).
3. Under Include Paragraph Styles, select an item you want to appear with a tab leader in the table of contents.
4. For Entry Style, select the paragraph style that contains the tab leader.
5. Click More Options.
6. Verify that Between Entry And Number is set to ^t (representing a tab). Click OK or Save to exit.
7. Update the table of contents, if necessary, by choosing Layout > Update Table Of Contents. Otherwise, place the new table of contents story.

[To the top](#)

Create a paragraph style with a tab leader

1. Choose Window > Styles > Paragraph Styles to display the Paragraph Styles panel.
2. In the Paragraph Styles panel, do one of the following:
 - Double-click the name of the paragraph style applied to entries in your table of contents.
 - From the panel menu, choose New Paragraph Style.

3. Enter a name, if necessary, for the paragraph style.
4. Click Tabs.
5. Select the right-justified tab icon , and then click on the ruler to position the tab stop.

If the paragraphs you're applying the style to include numbered list items, make sure that you include two tab settings — the first for the indented number and the second for the tab leader.

6. For Leader, type a period (.).
7. Select other style options as desired, and click OK.

[To the top](#)

Update and edit a table of contents

The table of contents is like a snapshot of content in your document. If page numbers in your document change, or if you edit headings or other elements associated with table of contents entries, you'll need to regenerate the table of contents to update it.

Update a table of contents

1. Open the document containing the table of contents.
2. Do any of the following:
 - To make changes to table of contents entries, edit your document or booked documents, not the table of contents story itself.
 - To change the formatting applied to the table of contents title, entries, or page numbers, edit the paragraph or character styles associated with these elements.
 - To change how pages are numbered (for example, 1, 2, 3 or i, ii, iii), change section numbering in the document or book. (See Number pages, chapters, and paragraphs in a book.)
 - To specify a new title, include other paragraph styles in the table of contents, or further format table of contents entries, edit the TOC style.
3. Select or place the insertion point in the text frame containing the table of contents, and then choose Layout > Update Table Of Contents.
4. If you have multiple tables of contents in your document, such as a list of figures and a list of advertisers, select the text frame containing a different list, and then choose Layout > Update Table Of Contents.

Editing a table of contents

If your table of contents requires editing, edit the actual paragraphs in the document—not the table of contents story—and then generate a new table of contents. If you edit the table of contents story, you'll lose your revisions when you generate a new table of contents. For the same reason, you should edit the styles used to format the table of contents entries, rather than formatting the table of contents directly.

Adobe also recommends

- [Creating a Table of Contents video](#)

Liquid Layouts and Alternate Layouts | CC, CS6

What's covered

Recommended workflow

Liquid layouts

Liquid page rules

Alternate layouts

Create Alternate Layouts

Alternate layouts and Liquid Layout page rules, give you the flexibility to efficiently design for multiple page sizes, orientations, or aspect ratios.

For publishing for multiple formats and sizes, you can choose a design strategy that suits a project best: Hand crafted, semi-automated, or fully automated. The degree of design control decreases as you rely on automated workflows. InDesign provides several enhancements for your adopted strategy to balance cost and control.

Note: Automatic Liquid Layout based-publishing is not possible yet, because of the unavailability of compliant viewer technologies.

[To the top](#)

Recommended workflow

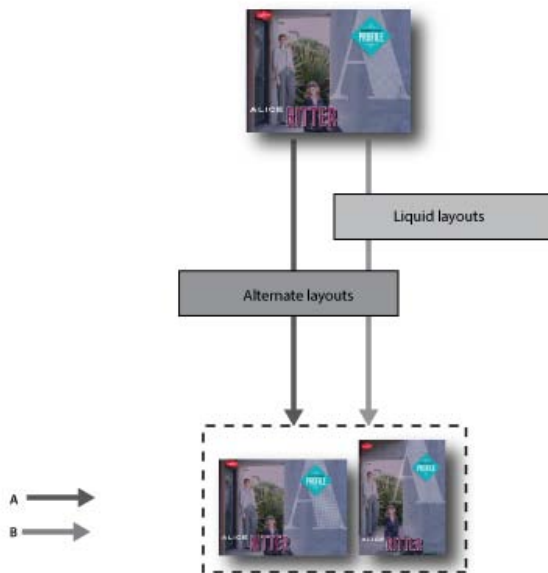

A. Alternate layout workflow **B.** Alternate layout and liquid page rules

STEP 1: Choose a target device and its corresponding dimension and orientation. Then create your primary layout for all the pages.

STEP 2: Optionally, add Adobe Liquid Layout page rules to help adapt content to different aspect ratios and sizes. Liquid page rules are useful if you're targeting multiple devices. Without Liquid page rules, you'll have to manually create a unique layout for every possible size and orientation. See [Liquid layouts](#).

STEP 3: Use the Create Alternate Layout feature to create new pages in the same document. Depending on your primary layout and the Liquid page rules, you may need to manually tune the layout. Repeat this step for each new size and orientation. See [Alternate layouts](#).

[To the top](#)

Liquid layouts



Liquid layouts

Liquid layouts make it easier to design content for multiple page sizes, orientations, or devices. Apply liquid page rules to determine how objects on a page are adapted when you create alternate layouts and change the size, orientation, or aspect ratio.

You can apply different rules to different pages, depending on the layout and the goals; only one liquid page rule can be applied to a page at a time. Liquid Layout is a general term that covers a set of specific liquid page rules: scale, re-center, guide-based, and object-based page rules.

Use Liquid page rules to adapt content for output sizes.

- To adapt layouts when creating new pages in the same document using alternate layouts.
- To adapt layouts when changing existing page sizes. This is more efficient than the previous Layout Adjustment feature.

To apply a liquid page rule, select the Page tool  and click a page. Then choose a liquid page rule from the control bar. You can also use the Layout > Liquid Layouts.

To preview the effects of the applied rule, use the Page tool to drag the page handles to resize the page. The page snaps back to original size when you release it.

 To resize the page, press **Alt** (Windows) or **Option** (Mac OS) and then drag. Using the mouse, however, to resize the page could result in pages that are slightly off the intended size. It's more accurate to resize the page with the Height and Width widgets in the control bar.

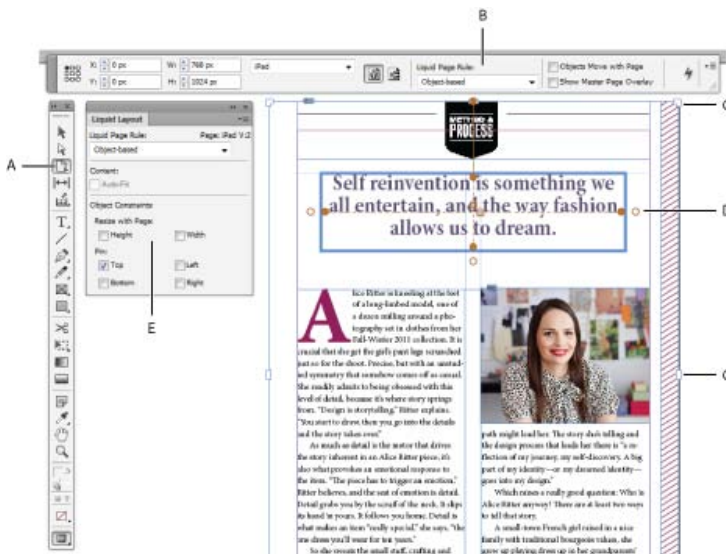

Liquid page rules

A. Page tool **B.** Liquid page rules from control bar **C.** Page handles **D.** Pins for object-based rules **E.** Liquid Layout panel

Liquid page rules

You can apply different rules to different pages. Only one liquid page rule can be applied to a page at a time.

Watch this video to discover how to apply None, Scale, and Recenter rules when resizing a layout. Also learn the meaning behind "Based on

Master." [Using basic Liquid Layout rules: Scale, Recenter, and Based on Master.](#)

Scale All content on the page is treated as a group, and as the page resizes, all the elements scale in proportion. The result is similar to letterboxing or pillarboxing on HD television screens.



Liquid page rules: Scale

Re-center All content on the page is automatically recentered no matter the width. Unlike Scale, the content remains its original size. You can achieve a similar result to video production safe zones using the Re-center rule with careful planning and layout.



Liquid page rules: Re-center

Guide-based Guides define a straight line across the page where content can adapt.

- Whitespace can be added
- Text frames are resized, and the text reflows (but not scale).
- Placed image frames are resized and the cropping boundary dimension of the containing frame resizes.

To add a liquid guide, first select the page tool, then pull out the guides from the ruler.

Guide-based rules are similar to 3-slice and 9-slice scaling in Illustrator, Fireworks, and Flash. Watch this video on [Applying guide-based Liquid Layout rules.](#)

 To convert a ruler guide to a liquid guide select the page tool and click the Convert to liquid guide icon on the guide. The liquid guide is displayed as a dashed line, while a ruler guide is a solid line.



Liquid page rules: Guide-based

Object-based You can specify liquid behavior for size and location relative to the page edge for each object, either fixed or relative.

- Each side of an object's bounding box or frame can either be fixed, or relative to its corresponding page edge. For example, the left side of the frame can have a relationship only with the left edge of the page.
- The height and width can either be fixed, or resizable relative to the page.

Watch this video on [Applying object-based Liquid Layout rules](#).



Liquid page rules: Object-based

[To the top](#)

Alternate layouts

Use Alternate Layouts if you require different page sizes for print or digital publishing within the same document. You can use it to create different sizes of a print advertisement. Or to design the horizontal and vertical layouts for devices such as the Apple iPad or Android tablets.

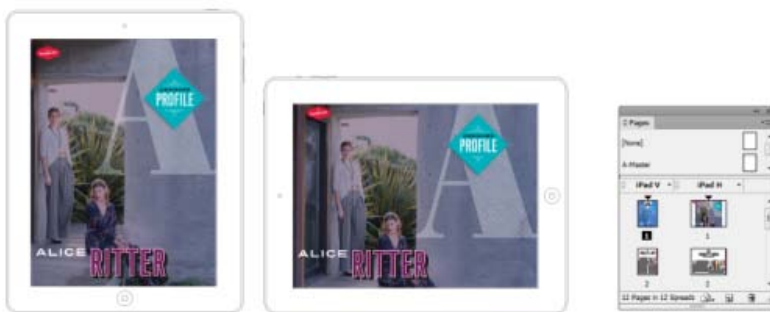

Alternate layouts and Pages panel

Used in combination with Liquid Layout, you can significantly reduce the amount of manual work required to re-layout content for every new page size and orientation.

For a quick overview see [Alternate Layouts](#) video by Lynda.com.

Create Alternate Layouts

To create an alternate layout, do one of the following:

- Choose Layout > Create Alternate Layout
- Choose Create Alternate Layout from the Pages panel menu

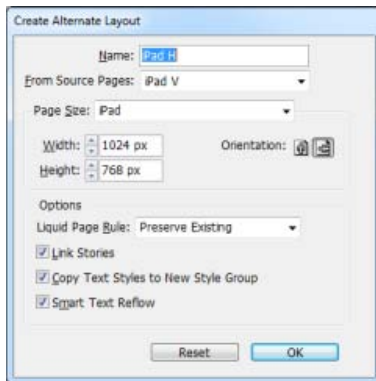

Create Alternate Layouts

In the Create Alternate Layouts dialog box, specify the following options:

Name Enter the name of the alternate layout.

From Source Pages Select the source layout where your content is located.

Page Size Select a page size or enter a custom size for the alternate layout.

Width and Height These fields display the size of the alternate layout. You can enter your own values, but that changes the Page Size to custom.

Orientation Choose an orientation for the alternate layout. If you switch between Portrait and Landscape, the Height and Width are updated.

Liquid Page Rule Choose a liquid page rule to apply to the alternate layout. Select Preserve Existing to inherit the liquid page rules applied to the source pages. Select another rule to apply new liquid page rules.

Link Stories Enable this option to place objects and to link them to the original objects on the source layout. When you update the original object, it is easier to manage updates for linked objects. See [Linked Content](#).

Copy Text Styles to New Style Group Enable this option to copy all text styles, and place them in a new group. This option is useful if you need to vary the text styles between various layouts.

Smart Text Reflow Enable this option to remove any forced line breaks and other style overrides to the text.

Twitter™ and Facebook posts are not covered under the terms of Creative Commons.

[Legal Notices](#) | [Online Privacy Policy](#)

Linked content | CC, CS6

Content Collector tools

[Place and link](#)

[Specify link options](#)

[Custom Style Mapping](#)

[Update a linked item](#)

Replicating content across various pages is no easy task; copy-pasting can be cumbersome and time consuming. Use linked content features to manage multiple versions of content. You can place and link content within the same document or even across different documents. Linked content makes it easier to support emerging workflows, where for example, you design for vertical and horizontal layouts. Linked content also works well for traditional print and publishing workflows, where you synchronize boilerplate text on different pages or documents.

Linked content behaves similar to traditional links. See [Use the Links panel](#) for an overview. You can designate an object as parent, and then place it at other places as child objects. Whenever you update the parent object, the child objects are flagged and you can update them to synchronize with the parent.

You can place and link objects using either the [Content Collector tools](#), or choose [Edit > Place and Link](#) menu command.



The  icon displays on the upper-left corner of linked object. The item is displayed as linked object in the Links panel.

[To the top](#)

Content Collector tools

Content Collector and Placer tools let you duplicate page items and place them on open InDesign documents. As content is collected, it is displayed in the Content Conveyor. Use Content Conveyor to easily and quickly place and link multiple page items within and across open documents.

Click  in the toolbox to open the Content Conveyor.

- Use Content Collector  tool to select an object and add it to the conveyor
- Use Content Placer  to place page object on a page

 *Press B to toggle between Content Collector and Content Placer tool.*



Content Conveyor

A. Content Collector tool **B.** Content placer tool **C.** Create link **D.** Map styles **E.** Edit Custom Style Mapping **F.** Place options **G.** Browse **H.** Collect All Threaded Frames **I.** Load Conveyor

Content Collector Use the Content Collector to add page items to the Content Conveyor.

Content Placer Use the Content Placer to place the items from the Content Conveyor to the document. When you select this tool, the current item is added to the place gun.

Create Link Enable Create Link to link the placed item to the original location of the collected item. You can manage the links using the Links

panel.

Map Styles Map paragraph, character, table, or cell styles, between the original and placed items. By default, style names are used for mapping. See [Custom style mapping](#).

Edit Custom Style Mapping Define custom style mapping between the original and placed items. Map the styles to automatically replace original styles in the placed item.

Place Options Specify the Conveyor options while placing items.

- Remove items from the conveyor after you place them
- Place the current item multiple times. The item remains loaded in the place gun.
- Place the item and move to the next item. The item is however kept in the conveyor.

Browse Navigate through the items in the Content Conveyor.

Collect All Threaded Frames Enable this option to collect all threaded frames. The story and all frames are collected. If this option is disabled, the story is collected in a single frame.

Load Conveyor Use  to load the conveyor with items.

- Selection: Use this option to load all selected items
- Pages: Use this option to load all items on the specified pages
- All: Use this option to load items from all pages and pasteboard

Enable Create Single set to group all the items in a single set.

You can collect individual page items, or collect related items as "sets." In some cases InDesign automatically creates sets to preserve the relational integrity of the page items.

The following are a few method of collecting items as sets, some manual and some automatic:

- Marquee select a number of items
- Use the Load Conveyor option and then select range of pages or all document content or selected items and items will be accordingly collected in a set.
- Collect an item that has related content such as a part of an interactive button that has other items and states associated with it, it will collect all related items in a set (this set will always drop in one gesture)
- Collect a text box with threaded text spanning into other objects and 'collect All Threaded Text Frames' checkbox is checked on the conveyor, it will pick all threaded text boxes into a set.

[To the top](#)

Place and link

1. Select a page item by either selecting the frame or place the insertion cursor in the text. You can also select multiple items by using Shift+Click.
2. Choose Edit > Place and Link. The cursor is loaded with the items, and the items display in the Content Conveyor.
3. Click on a page or draw a frame to place the linked item.

[To the top](#)

Specify link options

1. In the Links panel, select the linked item.

- From the Links panel menu, choose Link Options.

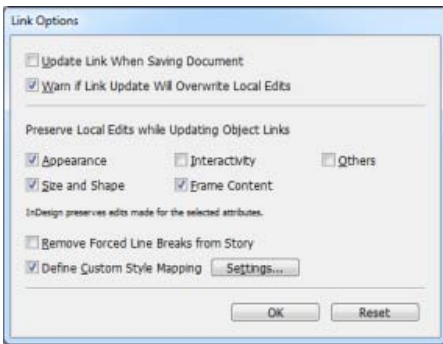

 Press *Alt* (Windows) or *Option* (Mac OS) to change the Cancel button to Reset. Click Reset to revert to default options.

- Select the options as required:

Update Link When Saving Document Enable this option to update the link when you save the document.

Warn if Link Update Will Overwrite Local Edits Enable this option to show a warning message if updating the link will overwrite any local edits made to the linked object.

Preserve Local Edits while Updating Object Links Select from the available categories to preserve local edits while updating links.

Category	Examples
Appearance	Object style attributes such as Stroke, Fill, Effects. This excludes any text or text frame related attributes, such as overprinting, non-printing settings etc
Size and Shape	Height, width, transforms, text frame attributes, and other column size attributes
Interactivity	Animation, object States, button actions
Frame Content	Image, video, content placed or pasted into frames, and effects and settings applied directly to such objects.
Others	Attributes excluded from other categories, such as text wrap on frames, object export options; text frame attributes such as , baseline options, auto-size options, vertical justification and so on.

Remove Forced Line Breaks from Story Enable to remove any forced line breaks in the story. Removing line breaks lets the text reflow smoothly in the linked frame if it is resized or reformatted.

Define Custom Style Mapping Enable this option if you want to map styles, and automatically apply another style to the linked content instead. See [Custom style mapping](#).

 To specify default link options, with all documents closed, open the links panel menu and choose Link Options.

[To the top](#)

Custom Style Mapping

Text styles (paragraph, character, table, cell) or style groups can be mapped to different styles while linking. The mapped styles are automatically applied to the linked content, instead of the original styles applied to the parent. Custom style mapping comes in handy, for example, when you want to use sans serif fonts for digital and serif fonts for print publications. Or if you want, vary the text style between the horizontal and vertical layouts.

To define custom style mapping, do one of the following:

- In the Link Options dialog box (Links panel > Link Options), enable Define Custom Style Mapping and then click Settings.
- Click  in the Content Conveyor.

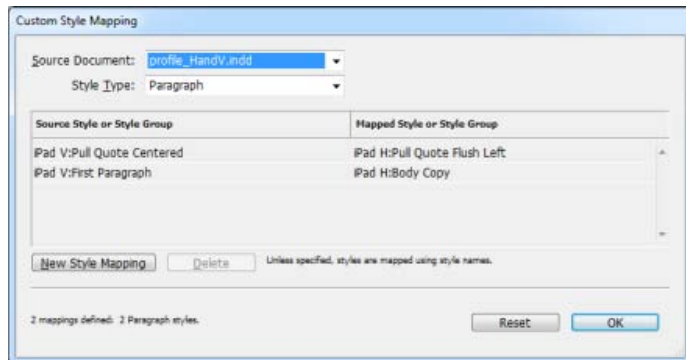

Custom Style Mapping



1. Select a source document and Style type.
2. Click New Syle Mapping.
3. Choose source and mapped styles or style groups from the list

 Press **Alt** (Windows) or **Option** (Mac OS) to change the Cancel button to Reset. Click Reset to revert to default options.

[To the top](#)

Update a linked item

If an original item is modified,  symbol displays over the frame and in the Links panel. To update do one of the following:

- Click  near the top-left of the frame
- In the Links panel, double-click  symbol

If you have made local edits to a child item, the edits are overwritten with content from the original item. If you set Warn if Link Update Will Overwrite Local Edits, a warning message displays.

 Use the Link Info pane to determine if you've made local edits to the story; story status displays "Text Modified" if you've made local edits.

 Twitter™ and Facebook posts are not covered under the terms of Creative Commons.

[Legal Notices](#) | [Online Privacy Policy](#)

Creating type on a path

[Create type on a path](#)

[Edit or delete type on a path](#)

[Adjust the type on a path position](#)

[Apply an effect to type on a path](#)

[Add anchored objects to type on a path](#)

[To the top](#)

Create type on a path

You can format text to flow along the edge of an open or closed path of any shape. Apply options and effects to type on a path: Slide it along the path, flip it over to the other side of the path, or use the shape of the path to distort the characters. Type on a path has an in port and an out port just like other text frames, so you can thread text to and from it.

You can include only one line of type on a path, so any type that won't fit on the path will be overset (hidden), unless you've threaded it to another path or text frame. You can add inline or above line anchored objects to type on a path. You can't create type on a path using compound paths, such as those that result from using the Create Outlines command.

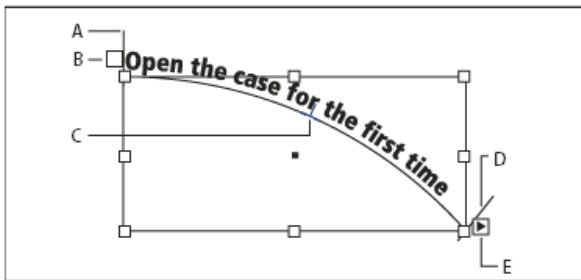

Type on a path

A. Start bracket **B.** In port **C.** Center bracket **D.** End bracket **E.** Out port indicating threaded text

1. Select the Type On A Path tool . (Click and hold the Type tool to display a menu containing the Type On A Path tool.)
2. Position the pointer on the path until a small plus sign appears next to the pointer , and then follow these steps:
 - To type using default settings, click the path. An insertion point appears at the start of the path by default. If the current default paragraph settings specify an indent, or any alignment other than left, the insertion point may appear somewhere other than at the start of the path.
 - To confine the text to a specific portion of the path, click the path where you would like the text to start, and drag along the path to where you want the text to end, then release the mouse. (For information about changing the start and end position of text, see [Adjust the type on a path position.](#))



Changing location of type on path

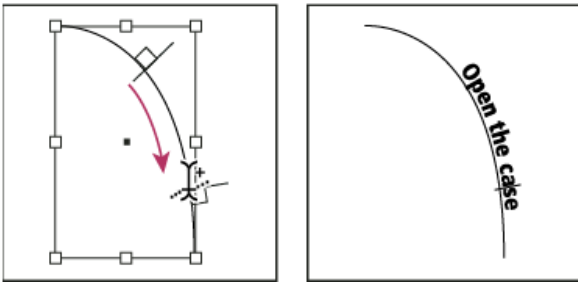

Changing location of type on path

Note: If neither clicking nor dragging seems to work, make sure that the small plus sign appears next to the Type On A Path tool.

3. Type the text you want. If you clicked to place the insertion point on the path, type will appear along the entire length of the path. If you dragged, type will appear only along the length you dragged.

Note: If the path was originally visible, it remains visible after you add type to it. To hide the path, select it with the Selection or Direct Selection tool, and then apply a fill and stroke of None.

[To the top](#)



Edit or delete type on a path

You can apply character and paragraph options to type on a path. However, paragraph rules and paragraph spacing options have no effect on type on a path. The alignment setting in the Paragraph panel controls the alignment of type on a path.

Edit and format path-type characters

1. Using the Type On A Path tool, do one of the following:
 - To add an insertion point, click between any two characters in the type on a path.
 - To select characters, drag through the type on a path.
2. Edit and format the text as needed.

Delete type from a path

1. Using the Selection tool  or Direct Selection tool , select one or more type-on-a-path objects.
2. Choose Type > Type on a Path > Delete Type From Path.

If the path text is threaded, type moves to the next threaded text frame or type-on-a-path object. If the path text isn't threaded, text is deleted. The path remains, but loses any type-on-a-path attributes—all brackets, in and out ports, and threading properties are removed.

Note: If the path's fill and stroke are set to None, the path is invisible after you delete the type. To make the path visible, press the D key immediately after you choose Type > Type on a Path > Delete Type From Path. This applies the default fill and stroke to the selected path.

Tighten character spacing around sharp turns and acute angles

1. Using the Selection tool or the Type tool, select the type on a path.

2. Choose Type > Type on a Path > Options, or double-click the Type On A Path tool.
3. For Spacing, type a value in points. Higher values remove the extra space from between characters positioned on sharp curves or angles.

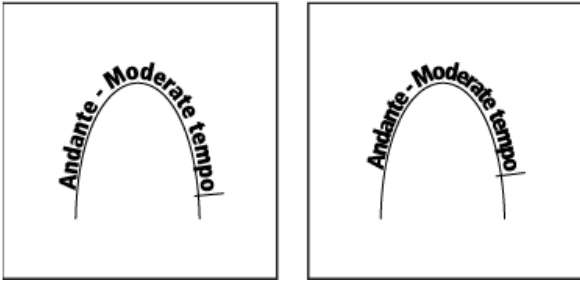

Type on a path before (left) and after (right) applying spacing adjustment



Note: The Spacing value compensates for the way characters fan out around a curve or sharp angle. It has no effect on characters positioned on straight segments. To change spacing of characters anywhere along the path, select them, and then apply kerning or tracking.

[To the top](#)

Adjust the type on a path position

You can change the start or end position of type on a path, slide type, and change the path position in other ways.

Change the start or end position of type on a path

1. Using the Selection tool , select the type on a path.
2. Position the pointer over the path type's start or end bracket until a small icon appears next to the pointer . Do not position it over the bracket's in port or out port.

 Zoom in on the path to more easily select the bracket.

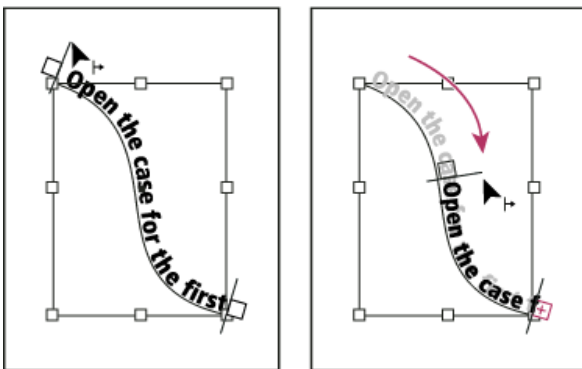

3. Drag the start or end bracket along the path.



Position the pointer on start or end bracket, and then drag to reposition boundary of type on a path.



Note: If you apply a paragraph indent value, it's measured from the start and end brackets.

Slide type along a path

1. Using the Selection tool , select the type on a path.
 2. Position the pointer over the path type's center bracket until a center bracket icon appears next to the pointer .
-  Zoom in on the path to more easily select the bracket.
3. Drag the center bracket along the path.

Note: The text won't move if both the start and end brackets are at the ends of the path. To create some space for dragging text, drag the start or end bracket away from the ends of the path.

Flip type on a path

1. Click the Selection tool , and select the type on a path.
2. Position the pointer over the type's center bracket until a center bracket icon appears next to the pointer .
3. Drag the center bracket across the path.

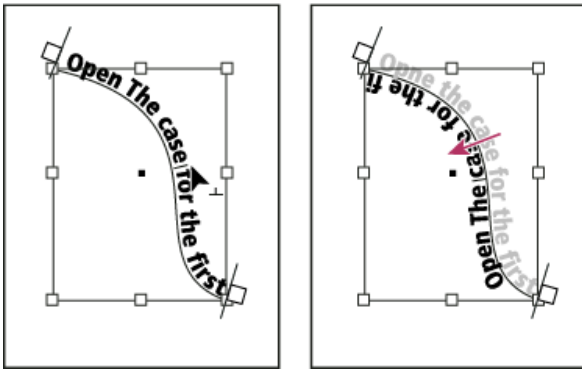

Position pointer on center bracket, and then drag across path to flip type.

You can also flip type on a path using a dialog box. Using the Selection tool or the Type tool, select the type on a path. Choose Type > Type on a Path > Options. Select the Flip option, and then click OK.

[To the top](#)

Apply an effect to type on a path

1. Using the Selection tool or the Type tool, select the type on a path.
2. Choose Type > Type on a Path > Options, or double-click the Type On A Path tool.
3. Choose one of the following in the Effect menu, and then click OK:
 - To keep the center of each character's baseline parallel to the path's tangent, choose Rainbow. This is the default setting.

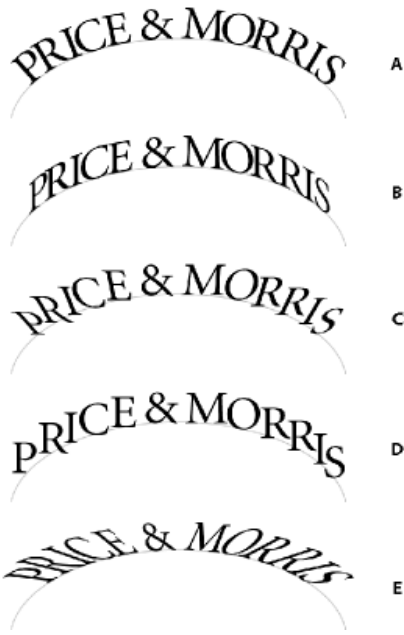

Type on a path effects

A. Rainbow effect B. Skew effect C. 3D Ribbon effect D. Stair Step effect E. Gravity effect

- To keep characters' vertical edges perfectly vertical regardless of the path shape, while letting characters' horizontal edges follow the path, choose Skew. The resulting horizontal distortion is useful for text that appears to follow waves or go around a cylinder, as on a beverage can label.
- To keep characters' horizontal edges perfectly horizontal regardless of the path shape, while keeping each character's vertical edge perpendicular to the path, choose 3D Ribbon.
- To keep the left edge of each character's baseline on the path without rotating any characters, choose Stair Step.
- To keep the center of each character's baseline on the path while keeping each vertical edge in line with the path's center point, choose Gravity. You can control this option's perspective effect by adjusting the arc of the text's path.

[To the top](#)

Add anchored objects to type on a path

1. Using the Type tool or the Type On A Path tool, click an insertion point in the text where you want the anchor for the object to appear.
2. Add the anchored object. You can add inline or above line anchored objects or frames to the path. (See Anchored objects.)

Note: The options available for above line anchored objects in a text path differ slightly from options for anchored objects in a regular text frame: the Alignment option is relative to the anchored object marker and the Space Before option is not available.

 Twitter™ and Facebook posts are not covered under the terms of Creative Commons.

[Legal Notices](#) | [Online Privacy Policy](#)

Creating documents

[Customize the pasteboard and guides](#)
[Change document setup, margins, and columns](#)

For detailed information and instructions, click the links below.

[To the top](#)

Customize the pasteboard and guides

You can control the colors used to display guides for page margins and columns, as well as the guides for the bleed and slug areas on the pasteboard. To make it easier to distinguish between the Normal and Preview modes, you can change the color of the preview background. InDesign also lets you control how close an object needs to be to snap to a guide, whether guides should be displayed in front of or behind objects, as well as the size of the pasteboard.

1. Choose Edit > Preferences > Guides & Pasteboard (Windows) or InDesign > Preferences > Guides & Pasteboard (Mac OS).
2. Under Color, choose the desired colors from each of the following menus, or choose Custom to specify a custom color using the color picker.

Margins Sets the color of the page margins.

Columns Sets the color of the column guides for the page.

Bleed Sets the color of the bleed area (which is set in the Document Setup dialog box).

Slug Sets the color of the slug area (which is set in the Document Setup dialog box).

Preview Background Sets the color of the pasteboard when in the Preview mode.

3. To set how close an object must be to snap to a guide or grid, specify a value in pixels for Snap To Zone.
4. To display guides behind objects, select Guides In Back.
5. To specify how far the pasteboard extends out from the page or spread (or the bleed or slug area, if specified), enter values for Horizontal Margins and Vertical Margins.
6. Click OK to close the Preferences dialog box.

 You can change the on-screen color of your paper. With no text or objects selected, double-click the Paper color in the Swatches panel (choose Window > Swatches). The Paper color appears on-screen only and does not affect output; it is intended only to simulate designing for nonwhite paper.

[To the top](#)

Change document setup, margins, and columns

After you create a document, you may change your mind about how you want it set up. For example, you may want single pages instead of facing pages, or you may want to change the page size or margin settings.

Change document setup

Changing options in the Document Setup dialog box affects every page in the document. If you change page size or orientation after objects have been added to pages, you can use the Layout Adjustment feature to minimize the amount of time needed for arranging existing objects. See About automatic layout adjustment.

1. Choose File > Document Setup.
2. Specify the document options, and then click OK. (See New Document options.)

Change page margin and column settings

You can change column and margin settings for pages and spreads. When you change the column and margin settings on a master page, you change the setting for all pages to which the master is applied. Changing the columns and margins of regular pages affects only those pages selected in the Pages panel.

Note: *The Margins And Columns dialog box doesn't alter columns inside text frames. Text frame columns exist only within individual text frames, not on the page itself. You can set up columns within individual text frames by using the Text Frame Options dialog box. (See Add columns to a text frame.) Text frame columns can also be affected by the Layout Adjustment feature.*

1. Do one of the following:
 - To change margin and column settings for one spread or page, go to the spread you want to change, or select one spread or page in the Pages panel.
 - To change margin and column settings for multiple pages, select those pages in the Pages panel, or select a master that controls the pages you want to change.
2. Choose Layout > Margins And Columns, specify the following options, and then click OK.

Margins Type values to specify the distance between margin guides and each edge of the page. If Facing Pages is selected in the New Document or Document Setup dialog box, the Left and Right margin option names change to Inside and Outside, so that you can specify additional inside margin space to accommodate binding.

Columns Specify the number of columns.

Select Horizontal or Vertical to specify the column direction. This also sets the writing direction of the document baseline grid.

Create unequal column widths

When you have more than one column on a page, the column guides in the middle appear in pairs. When you drag one column guide, the pair moves. The space between the column guides is the gutter value you specified; the pair moves together to maintain that value.

Note: *You cannot create unequal column widths for columns in a text frame. Instead, create threaded, side-by-side text frames with different column widths.*

1. Go to the master or spread you want to change.

2. If column guides are locked, choose View > Grids & Guides > Lock Column Guides to deselect it.

3. Using the Selection tool , drag a column guide. You can't drag it past an adjacent column guide or beyond the edge of the page.

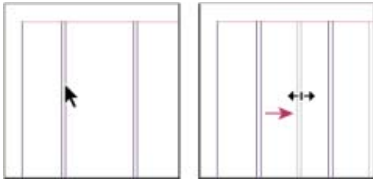

Dragging a column guide to create unequal column widths

 *To create columns with unequal gutters, create evenly spaced ruler guides and then drag individual guides to the desired location. (See [Create ruler guides](#).)*

Adobe also recommends

 Twitter™ and Facebook posts are not covered under the terms of Creative Commons.

[Legal Notices](#) | [Online Privacy Policy](#)

Create new documents (Chinese, Japanese, and Korean only)

Creating new documents

[Create a new document](#)

[Create a new document with a layout grid](#)

[Create a new document with margins and columns](#)

[New Document options](#)

[Document window overview](#)

[Create custom page sizes](#)

[Define document presets](#)

[Create a document using a preset](#)

Page design begins with the basics: starting a new document, setting up pages, and positioning margins and columns or changing grid settings.

When creating a document you can select from two workflows, either Layout Grid or Margins and Columns.

note: *Whichever workflow you select, the file type of the document will be exactly the same. You can view a layout grid created in the document using Margins and Columns, or hide a document layout grid created using the Layout Grid option by switching between views.*

The workflow based on typesetting composition using Layout Grid is only available in Asian language versions. When you select Layout Grid, a grid of squares will be displayed in the document. You can set the number of individual squares (number of rows or characters) from the page size settings. Page margins will also be determined by this. By using a layout grid you can position an object accurately on a page using grid cell units.

The Margins and Columns workflow option is the same as in Western workflows. Western workflows are configured from Margins and Columns, and objects are arranged on pages without layout grids. You can set the writing direction to horizontal or vertical using either the Margins and Columns or Layout Grid workflow.



A document showing a layout grid (left) A document showing margins and columns (right)

[To the top](#)

Create a new document

1. Choose File > New > Document.

The New Document dialog box combines the Document Setup and the Margins And Columns dialog boxes, so that you can set up the page size, margins, and page columns all in one place. You can change these settings at any time.

2. Specify document setup options. (See New Document options.)

To specify the dimensions of the bleed and slug areas, click More Options. The bleed and slug areas extend out from the edges of the defined Page Size. To make the bleed or slug areas extend evenly on all sides, click the Make All Settings The Same icon .

3. Click OK to open a new document with the settings you specified.

Note: *To set default layout settings for all new documents, choose File > Document Setup or Layout > Margins And Columns, and set options when no documents are open.*

Create a new document with a layout grid

1. Choose File > New > Document.
2. Change the number of pages, page size, and other options. To specify the dimensions of the bleed and slug areas, click More Options.
3. Click Layout Grid Dialog, and then specify the layout grid settings. (See [Layout Grid options.](#))
4. Click OK to open a new document with the settings you specified.

The layout grid is for layout purposes only. To add text to your document, add frame grids or text frames.

Create a new document with margins and columns

When creating a document with Western style workflow, use Margins and Columns. If the general layout settings such as margins and number of columns in a document are already known, use the Margins and Columns dialog box as the simplest method.

1. Choose File > New > Document.
2. Specify options using the New Document dialog box. Each option is the same as when creating a document using a layout grid.
3. Click Margins and Columns and select your options using the New Margins and Columns dialog box. The options are the same as in the Margins and Columns dialog box. (See [Change document setup, margins, and columns.](#))
4. Click OK.

Even when a document has been created using Margins and Columns, you can view its layout grid by choosing View > Grids & Guides > Show Layout Grid, and you can modify the layout grid settings by choosing Layout > Layout Grid.

 *To set the default settings for all new documents, choose File > Document Setup, Layout > Margins and Columns, or Layout > Layout Grid Settings, and set options when no documents are open.*

New Document options

Document Preset Choose a preset that you have saved earlier.

Intent If you are creating a document to be output to PDF or SWF for the web, choosing the Web option changes several options in the dialog box, such as turning off Facing Pages, changing the orientation from portrait to landscape, and using a page size based on monitor resolution. You can edit any of these settings, but you cannot change the Intent setting after the document is created.

CS6: Digital publishing intent has been added for publications aimed for the Digital Publishing Suite.

Number of pages Specify the number of pages to create in the new document.

Start Page # Specify which number the document starts on. If you specify an even number (such as 2) with Facing Pages selected, the first spread in the document begins with a two-page spread. See [Start a document with a two-page spread](#).



Facing Pages Select this option to make left and right pages face each other in a double-page *spread*, such as for books and magazines. Deselect this option to let each page stand alone, such as when you're printing flyers or posters or when you want objects to *bleed* in the binding. After you've created a document, you can use the Pages panel to create spreads with more than two pages or force the first two pages to open as a spread. (See [Control spread pagination](#).)

Master Text Frame *CS5.5 and earlier*: Select this option to create a text frame the size of the area within the margin guides, matching the column settings you specified. The master text frame is added to the A-Master. (See [Using text frames on master pages](#).)

The Master Text Frame option is available only when you've chosen File > New > Document.

Primary Text Frame *CS6 only*: select this option to add a primary text frame on the master page. When you apply a new master page, the story in the primary text frame automatically flows into the primary text frame of the new master page.

Page Size Choose a page size from the menu, or type values for Width and Height. Page size represents the final size you want after bleeds or other marks outside the page are trimmed.

Orientation Click Portrait  (tall) or Landscape  (wide). These icons interact dynamically with the dimensions you enter in Page Size. When Height is the larger value, the portrait icon is selected. When Width is the larger value, the landscape icon is selected. Clicking the deselected icon switches the Height and Width values.

Tip: To specify the dimensions of the bleed and slug areas, click *More Options* in the New Document dialog box. To make the bleed or slug areas extend evenly on all sides, click the *Make All Settings The Same* icon .

Bleed The Bleed area allows you to print objects that are arranged at the outer edge of the defined page size. For a page of the required dimensions, if an object is positioned at its edge, some white may appear at the edge of the printed area due to slight misalignment during printing or trimming. For this reason, you should position an object that is at the edge of the page of the required dimensions a little beyond the edge, and trim after printing. Bleed area is shown by a red line on the document. You can set bleed area settings from Bleed in the Print dialog box.

Slug The slug area is discarded when the document is trimmed to its final page size. The slug area holds printing information, customized color bar information, or displays other instructions and descriptions for other information in the document. Objects (including text frames) positioned in the slug area are printed but will disappear when the document is trimmed to its final page size.

Objects outside the bleed or slug area (whichever extends farther) do not print.

Note: You can also click the *Save Document Preset* icon to save document settings for future use.

[To the top](#)

Document window overview

Each page or spread in your document has its own pasteboard and guides, which are visible in Normal View mode. (To switch to Normal View, choose View > Screen Mode > Normal.) The pasteboard is replaced with a gray background when the document is viewed using one of the Preview modes. (See [Preview documents](#).) You can change the color of this preview background and guides in Guides & Pasteboard preferences.

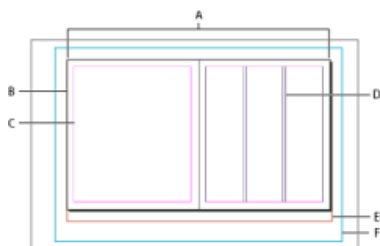

Document and guides in Normal View Mode

A. Spread (black lines) **B.** Page (black lines) **C.** Margin guides (magenta lines) **D.** Column guides (violet lines) **E.** Bleed area (red lines) **F.** Slug area (blue lines)

Document window notes:

- Lines of other colors are ruler guides which, when present, appear in the layer color when selected. See [Layers](#).
- Column guides appear in front of margin guides. When a column guide is exactly in front of a margin guide, it hides the margin guide.

[To the top](#)

Create custom page sizes

You can create custom page sizes that appear in the Page Size menu in the New Document dialog box.

1. Choose File > New > Document.
2. Choose Custom Page Size from the Page Size menu.
3. Type a name for the page size, specify page size settings, and then click Add.

The New Doc Sizes.txt file that lets you create custom page sizes in previous version of InDesign is not available in InDesign CS5 or later.

[To the top](#)

Define document presets

You can save document settings for page size, columns, margins, and bleed and slug areas in a preset to save time and ensure consistency when creating similar documents.

1. Choose File > Document Presets > Define.
2. Click New in the dialog box that appears.
3. Specify a name for the preset and select basic layout options in the New Document Preset dialog box. (See New Document options for a description of each option.)
4. Click OK twice.

 You can save a document preset to a separate file and distribute it to other users. To save and load document preset files, use the Save and Load buttons in the Document Presets dialog box.

[To the top](#)

Create a document using a preset

1. Do one of the following:
 - Choose File > Document Preset > *[name of preset]*. (Hold down Shift while choosing the preset to create a new document based on the preset without opening the New Document dialog box.)
 - Choose File > New > Document, and then choose a preset from the Document Preset menu in the New Document dialog box.

The New Document dialog box displays the preset layout options.

2. Make changes to the options (if desired) and click OK.

 *To skip the New Document dialog box, press the Shift key as you select a preset from the Document Preset menu.*

- [Recommended workflow for InDesign documents](#)
- [Use document templates](#)
- [Add documents to a book file](#)
- [Change document setup, margins, and columns](#)

 Twitter™ and Facebook posts are not covered under the terms of Creative Commons.

[Legal Notices](#) | [Online Privacy Policy](#)

Clipping paths

Clipping paths

[Crop using a graphic's path or alpha channel](#)

[Create a clipping path automatically](#)

[Clipping path options](#)

[Convert a clipping path to a graphics frame](#)

[To the top](#)

Clipping paths

Clipping paths crop part of the artwork so that only a portion of the artwork appears through the shape or shapes you create. You can create clipping paths to hide unwanted parts of an image, creating both a path for the image and a frame for the graphic. By keeping the clipping path and graphics frame separate, you can freely modify the clipping path without affecting the graphics frame by using the Direct Selection tool and other drawing tools in the toolbox.

You can create clipping paths in the following ways:

- Place already-saved graphics with paths or alpha (mask) channels, which InDesign can use automatically. You can add paths and alpha channels to graphics using a program such as Adobe Photoshop.
- Use the Detect Edges option in the Clipping Path command to generate a clipping path for a graphic that was saved without one.
- Use the Pen tool to draw a path in the shape you want, and then use the Paste Into command to paste the graphic into the path.

When you use one of InDesign's automatic methods to generate a clipping path, the clipping path is attached to the image, resulting in an image that is clipped by the path and cropped by the frame.

Note: *The graphics frame displays the color of the layer it appears on, and the clipping path is drawn in the inverse color of the layer. For example, if the layer color is blue, the graphics frame will appear as blue, and the clipping path will appear as orange.*

[To the top](#)

Crop using a graphic's path or alpha channel

InDesign can crop an imported EPS, TIFF, or Photoshop graphic using the clipping path or alpha channel saved with the file. When an imported graphic includes more than one path or alpha channel, you can choose which path or alpha channel to use for the clipping path.

An *alpha channel* is an invisible channel that defines transparent areas of a graphic. It's stored inside a graphic with the RGB or CMYK channels. Alpha channels are commonly used in video-effects applications. InDesign automatically recognizes Photoshop's default transparency (the checkerboard background) as an alpha channel. If the graphic has an opaque background, you must use Photoshop to remove the background, or create and save one or more alpha channels with the graphic. You can create alpha channels using background-removal features in Adobe Photoshop, such as layer masks, the Channels panel, the Background Eraser, or the Magic Eraser.

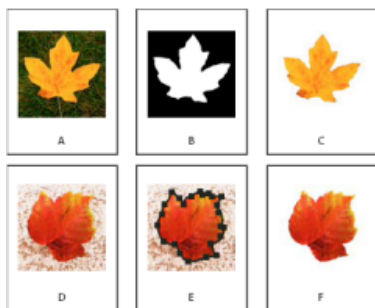

Results of using alpha channels and embedded paths

A. Original graphic B. Alpha channel C. Placed graphic D. Original graphic E. Graphic with embedded path F. Placed graphic

💡 When you place a Photoshop file, the Image Import Options dialog box lets you choose to use the default clipping path or select an alpha channel for clipping.

1. Select an imported graphic, and choose Object > Clipping Path.
2. In the Clipping Path dialog box, choose either Photoshop Path or Alpha Channel from the Type menu.
3. Choose the desired path or alpha channel from either the Path or Alpha menu.

Note: If the Alpha Channel menu command is not available, no alpha channels were saved with the graphic.

4. To inset the clipping path, specify a value for Inset Frame.
5. To switch the visible and hidden areas, select Invert.
6. If you chose an alpha channel, specify any other desired clipping path options, and click OK.

💡 To turn off the clipping path, select the imported graphic, and choose Object > Clipping Path. Choose None in the Type menu, and click OK.

[To the top](#)

Create a clipping path automatically

If you want to remove the background from a graphic that wasn't saved with a clipping path, you can do it automatically using the Detect Edges option in the Clipping Path dialog box. The Detect Edges option hides the lightest or darkest areas of a graphic, so it works best when the subject is set against a solid white or black background.



Good (left) and bad (right) candidates for automatic clipping path

1. Select an imported graphic, and choose Object > Clipping Path.
2. In the Clipping Path dialog box, choose Detect Edges in the Type menu. By default, the lightest tones are excluded; to exclude the darkest tones, also select the Invert option.
3. Specify the clipping path options, and click OK.

[To the top](#)

Clipping path options

Threshold Specifies the darkest pixel value that will define the resulting clipping path. Increasing this value makes more pixels transparent by extending the range of lightness values added to the hidden area, starting from 0 (white). For example, if you want to remove a very light drop shadow when using Detect Edges, try increasing the Threshold until the shadow disappears. If light pixels that should be visible are invisible, the Threshold is too high.



Threshold levels at 25 (left) and 55 (right)

Threshold Specifies how similar a pixel's lightness value can be to the Threshold value before the pixel is hidden by the clipping path. Increasing the Threshold value is useful for removing unwanted bumps caused by stray pixels that are darker than, but close to the lightness value of, the Threshold value. Higher Threshold values usually create a smoother, looser clipping path, by increasing the range of values near the Threshold value within which stray darker pixels are included. Decreasing the Threshold value is like tightening the clipping path around smaller variations in value. Lower Threshold values create a rougher clipping path by adding anchor points, which may make it harder to print the image.

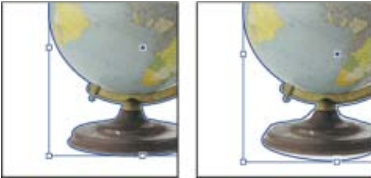

Tolerance levels at 0 (left) and 5 (right)

Inset Frame Shrinks the resulting clipping path relative to the clipping path defined by the Threshold and Tolerance values. Unlike Threshold and Tolerance, the Inset Frame value does not take lightness values into account; instead, it uniformly shrinks the shape of the clipping path. Adjusting the Inset Frame value slightly may help hide stray pixels that could not be eliminated by using the Threshold and Tolerance values. Enter a negative value to make the resulting clipping path larger than the clipping path defined by the Threshold and Tolerance values.

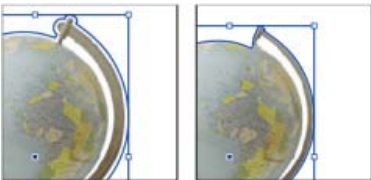

Inset frame at -0p1 (left) and 0p3 (right)

Invert Switches the visible and hidden areas, by starting the clipping path with the darkest tones.

Include Inside Edges Makes areas transparent if they exist inside the original clipping path, and if their lightness values are within the Threshold and Tolerance ranges. By default, the Clipping Path command makes only the outer areas transparent, so use Include Inside Edges to correctly represent "holes" in a graphic. This option works best when the brightness levels of areas you want to make transparent don't match any areas that must be visible. For example, if you choose Include Inside Edges for a graphic of silver eyeglasses, and the lenses become transparent, very light areas of the eyeglass frame may also become transparent. If areas become transparent when that wasn't your intent, try adjusting the Threshold, Tolerance, and Inset Frame values.

Restrict to Frame Creates a clipping path that stops at the visible edge of the graphic. This can result in a simpler path when you use the graphic's frame to crop the graphic.

Use High Resolution Image Calculates transparent areas using the actual file, for maximum precision. Deselect this option to calculate transparency based on the screen display resolution, which is faster but less precise. This option isn't available if you chose Alpha Channel, because InDesign always uses an alpha channel at its actual resolution. (See About transparency.)

[To the top](#)

Convert a clipping path to a graphics frame

- Choose Object > Clipping Path > Convert Clipping Path To Frame.

Adobe also recommends

- Create and edit alpha channel masks

 Twitter™ and Facebook posts are not covered under the terms of Creative Commons.

[Legal Notices](#) | [Online Privacy Policy](#)

Add basic page numbering

Adding page numbering

Add a page number marker to a master page

Change the page numbering style

Common page numbering tasks

You can add a *current page number* marker to your pages to specify where a page number sits on a page and how it will look. Because a page number marker updates automatically, the page number it displays is always correct—even as you add, remove, or rearrange pages in the document. Page number markers can be formatted and styled as text.

[To the top](#)

Add a page number marker to a master page

Page number markers are commonly added to master pages. When master pages are applied to document pages, the page numbering is updated automatically, similar to headers and footers.

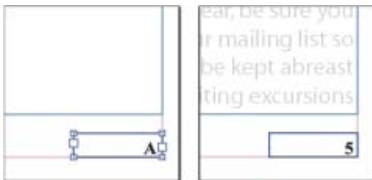

Page number on master A (left) and page 5 based on same master (right)

If the automatic page number is on a master page, it displays the master page prefix. On a document page, the automatic page number displays the page number. On a pasteboard, it displays PB.

1. In the Pages panel, double-click the master page to which you want to add your page number. To create master pages, see [Create masters](#).
2. Create a new text frame large enough to hold the longest page number and any text you want to appear next to it. Position the text frame where you want the page number to appear.

If your document has facing pages, create separate text frames for the left and right master pages.
3. In the page number text frame, add any text that will come before or after the page number (such as “Page “).
4. Position the insertion point where you want the page number to appear, and then choose Type > Insert Special Character > Markers > Current Page Number.
5. Apply the master page to the document pages on which you want the page numbering to appear. To apply master pages, see [Apply master pages](#).

 *To remove the page number from the first page in the document, you have two options. Either apply a different or the None master, or override and delete the master text frame on the document page. Ctrl/Cmd+Shift-click a master text frame to override it.*

[To the top](#)

Change the page numbering style

By default, pages are numbered using Arabic numerals (1, 2, 3...); however, you can number pages using upper or lowercase Roman (i, ii, iii...) or alphanumeric (a, b, c...) numbering. You can also number pages using preceding zeros. Each part of the document that uses a different numbering style is called a *section*. For more information on sections, see [Define section numbering](#).

Page Numbering Gallery



A visual gallery and quick tips on how to add page numbers.... [Read More](#)

<http://goo.gl/KKJvd>



by Bob Bringhurst

[Contribute your expertise to Adobe Community Help](#)

In Japanese, Chinese, or Korean versions, by default, Arabic numerals are used for page numbers. However, if you use the Numbering & Section Options command, you can specify the style of numbering, such as Roman numerals, Arabic numerals, Kanji, and so on. The Style option allows you to select the number of digits in the page number, for example, 001 or 0001. Each part of the document that uses a different numbering style is called a *section*. For more information on sections, see [Define section numbering](#).

Use the Numbering & Section Options dialog box to change the page numbering style to use a different format. You can also use this dialog box to restart page numbering or to start page numbering at a number you specify.

1. In the Pages panel, select the page where you want the new numbering style section to begin.
2. Choose Layout > Numbering & Section Options.
3. Specify options, and then click OK. See [Document numbering options](#).

A section indicator icon ▼ appears above the page icon in the Pages panel, indicating the start of a new section.

Note: If a number or letter appears before the current page number you inserted, it means a section prefix is included. If you don't want this prefix, deselect *Include Prefix When Numbering Pages* in the Numbering & Section Options dialog box.

[To the top](#)

Common page numbering tasks

InDesign offers several different features that help you create page numbering effects.

To do this:	Do this:
Add page numbering to documents in a book.	See Number pages, chapters, and paragraphs in a book .
Add section numbers and chapter numbers.	See Add section and chapter numbering .
Create running headers or running footers that use text variables such as the create date, filename, or the current heading or title.	See Create headers and footers and Text variables .

Create a "Page x of y" effect in which x is the current page and y is the total number of pages.	Insert a Current Page Number marker for x, and insert the Last Page Number text variable for y (choose Type > Text Variables > Insert Variable > Last Page Number).
Create a "Continued on page x" story jump.	See Add automatic page numbers for story jumps .

 Twitter™ and Facebook posts are not covered under the terms of Creative Commons.

[Legal Notices](#) | [Online Privacy Policy](#)

About pages and spreads

Change the page and spread display

Target or select a page or spread

Add new pages to a document

Create color labels for page thumbnails

When you select the Facing Pages option in the File > Document Setup dialog box, document pages are arranged in *spreads*. A spread is a set of pages viewed together, such as the two pages visible whenever you open a book or magazine. Every InDesign spread includes its own *pasteboard*, which is an area outside a page where you can store objects that aren't yet positioned on a page. Each spread's pasteboard provides space to accommodate objects that *bleed*, or extend past the edge of a page.



Pages panel

A. Page icons **B.** Page with master "A" applied **C.** Selected spread

When you set the Binding option to Right To Left in the Document Setup dialog box, numbers are attached to the page icons from right to left in the Pages panel.

 *In a long document, you can move to a page quickly by choosing Layout > Go To Page.*

[To the top](#)

Change the page and spread display

The Pages panel provides information about and control over pages, spreads, and *masters* (pages or spreads that automatically format other pages or spreads). By default, the Pages panel displays thumbnail representations of each page's content.

1. If the Pages panel isn't visible, choose Window > Pages.
2. Choose Panel Options in the Pages panel menu.
3. In the Icons section, specify which icons appear next to the page thumbnails in the Pages panel. These icons indicate whether transparency or page transitions have been added to a spread, and whether the spread view is rotated.
4. In the Pages and Masters sections:
 - Select an icon size for pages and masters.

- Select Show Vertically to display spreads in one vertical column. Deselect this option to allow spreads to be displayed side-by-side.
 - Select Show Thumbnails to display thumbnail representations of the content of each page or master. (This option is not available if certain options are selected for Icon Size.)
5. In the Panel Layout section, select Pages On Top to display the page icon section above the master icon section, or select Masters On Top to display the master icon section above the page icon section.
6. Choose an option in the Resize menu to control how the sections are displayed when you resize the panel:
- To resize both the Pages and Masters sections of the panel, choose Proportional.
 - To maintain the size of the Pages section and resize only the Masters section, choose Pages Fixed.
 - To maintain the size of the Masters section and resize only the Pages section, choose Masters Fixed.

[To the top](#)

Target or select a page or spread

You either *select* or *target* pages or spreads, depending on the task you are performing. Some commands affect the currently selected page or spread, while others affect the target page or spread. For example, you can drag ruler guides only to the target page or spread, but page-related commands, such as Duplicate Spread or Delete Page, affect the page or spread selected in the Pages panel. Targeting makes a page or spread active and is helpful when, for example, several spreads are visible in the document window and you want to paste an object onto a specific spread.

- In the Pages panel:
 - To both target and select a page or spread, double-click its icon or the page numbers under the icon. If the page or spread is not visible in the document window, it shifts into view.

Tip: You can also both target and select a page or spread by clicking a page, any object on the page, or its pasteboard in the document window.

The vertical ruler is dimmed alongside all but the targeted page or spread.
 - To select a page, click its icon. (Don't double-click unless you want to select it *and* move it into view.)
 - To select a spread, click the page numbers under the spread icon.

Note: Some spread options, such as those in the Pages panel menu, are available only when an entire spread is selected.

[To the top](#)

Add new pages to a document

- Do any of the following:
 - To add a page after the active page or spread, click the New Page button in the Pages panel or choose Layout > Pages > Add Page. The new page uses the same master as the existing active page.
 - To add multiple pages to the end of the document, choose File > Document Setup. In the Document Setup dialog box, specify the total number of pages for the document. InDesign adds pages after the last page or spread.
 - To add pages and specify the document master, choose Insert Pages from the Pages panel menu or choose Layout > Pages > Insert Pages. Choose where the pages will be added and select a master to apply.

[To the top](#)

Create color labels for page thumbnails

You can assign colored labels to the page thumbnails in the Pages panel. For example, you can use color labels to indicate the status of the pages, such as a green label for complete spreads, a yellow label for spreads being worked on, and a red label for unstarted spreads.

1. In the Pages panel, select the pages to which you want to apply the color labels.
2. From the Pages panel menu, choose Color Label, and then choose the color to assign.

The color label appears below the thumbnail in the Pages panel.

Applying a color label to master pages affects all pages to which the master is applied. However, when you apply a color label to individual document pages, the color label for the document pages is used. To use a color label for master pages, select the document pages you want to change and choose Color Label > Use Master Color from the Pages panel menu.

 Twitter™ and Facebook posts are not covered under the terms of Creative Commons.

[Legal Notices](#) | [Online Privacy Policy](#)

Text

[Creating conditional text \(video 6:48\), CS4-CS6](#)

David Blatner (Jan. 1, 2011)

video-tutorial

Learn how to use conditional text in InDesign.

[Linking text stories \(PDF, 217 KB\)](#)

article (Jan. 1, 2011)

A short tutorial on the Place and Link Story feature in InDesign CS5.5.

[Paragraphs that span and split columns \(video 2:01\)](#)

Michael Ninness (Jan. 1, 2011)

video-tutorial

See how to build complex layouts in less clicks with paragraphs that span or split columns in InDesign CS5 and later.

[Track text changes \(video 2:01\)](#)

Michael Ninness (Jan. 1, 2011)

video-tutorial

Learn how to collaborate with even greater efficiency using new Track Text Changes in InDesign CS5 and later.

Threading text

Thread text frames

Cut or delete threaded text frames

Flow text manually or automatically

Use Smart Text Reflow

[To the top](#)

Thread text frames

The text in a frame can be independent of other frames, or it can flow between connected frames. To flow text between connected frames (also called text boxes), you must first connect the frames. Connected frames can be on the same page or spread, or on another page in the document. The process of connecting text among frames is called *threading text*. It is also referred to as *linking text frames* or *linking text boxes*.

Each text frame contains an *in port* and an *out port*, which are used to make connections to other text frames. An empty in port or out port indicates the beginning or end of a story, respectively. An arrow in a port indicates that the frame is linked to another frame. A red plus sign (+) in an out port indicates that there is more text in the story to be placed but no more text frames in which to place it. This remaining unseen text is called *overset text*.

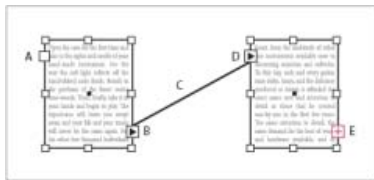

Threaded frames

A. In port at beginning of story **B.** Out port indicating thread to next frame **C.** Text thread **D.** In port indicating thread from previous frame **E.** Out port indicating overset text

Choose View > Extras > Show Text Threads to see visual representatives of threaded frames. You can thread text frames whether or not they contain text.

Add a new frame to the thread

1. Using the Selection tool , select a text frame, and then click the in port or out port to load a text icon.

Clicking the in port lets you add a frame before the selected frame; clicking the out port lets you add a frame after the selected frame.

2. Position the loaded text icon  where you want a new text frame to appear, and then click or drag to create a new text frame.

 When the loaded text icon is active, you can perform many actions, including turning pages, creating new pages, and zooming in and out. If you start to thread two frames and change your mind, you can cancel the thread by clicking any tool in the Toolbox. No text will be lost.

Add an existing frame to the thread

1. Using the Selection tool, select a text frame, and then click the in port or the out port to load a text icon.
2. Position the loaded text icon over the frame you want to connect to. The loaded text icon changes to the thread icon.

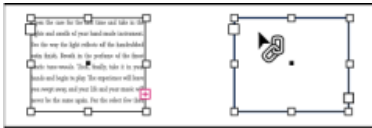

Adding existing frame to thread

3. Click inside the second frame to thread it to the first.

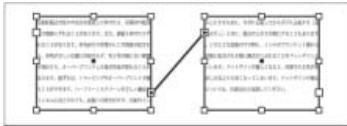

When you thread a frame grid to a plain text frame or to another frame grid with different grid settings, the text frame of the threaded frame is redefined to match the settings of the frame grid threaded from

 You can add automatic “continued on” or “continued from” jump lines that track threaded stories as they jump from frame to frame. (See [Add automatic page numbers for story jumps.](#))

Add a frame inside a sequence of threaded frames

1. Using the Selection tool, click the out port at the point in the story where you want to add a frame. When you release the mouse button, a loaded text icon appears.
2. Drag to create a new frame, or select a different text frame. InDesign threads the frame into the series of linked frames containing the story.

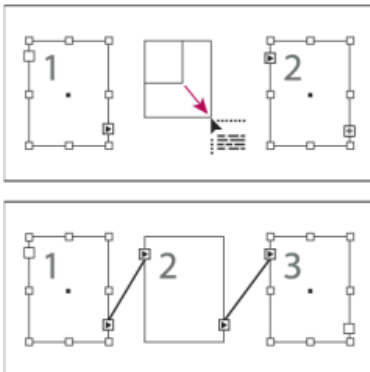

Adding frame inside a thread (top) and result (bottom)

Unthread text frames

When you unthread a text frame, you break the connection between the frame and all subsequent frames in the thread. Any text that previously appeared in the frames becomes overset text (no text is deleted). All subsequent frames are empty.

- Using the Selection tool, do one of the following:
 - Double-click an in port or out port to break the connection between frames.

- Click an in port or an out port that represents a thread to another frame. For example, in a two-framed thread, click either the out port of the first frame or the in port of the second frame. Position the loaded text icon over the previous or next frame to display the unthread icon . Click in the frame you want to remove from the thread.

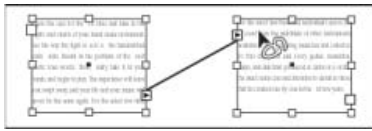

Removing frame from thread

-  To break one story into two stories, cut the text that needs to go in the second story, break the connection between the frames, and then paste the text into the first frame of the second story.

[To the top](#)

Cut or delete threaded text frames

Whenever you cut or delete text frames, no text is deleted; the text remains in the thread.

Cut a frame from a thread

You can cut a frame from a thread and paste the frame elsewhere. The frame is removed with a copy of the text, but no text is removed from the original story. When you cut and paste a series of threaded text frames at once, the pasted frames maintain their connection to each other, but lose connection to any other frames in the original story.

1. Using the Selection tool, select one or more frames (Shift-click to select multiple objects).
2. Choose Edit > Cut. The frame disappears, and any text contained in it flows to the next frame in the story. When you cut the last frame in a story, the text is stored as overset text in the previous frame.
3. If you want to use the disconnected frame elsewhere in your document, go to the page where you want the disconnected text to appear and choose Edit > Paste.

Delete a frame from a thread



When you delete a text frame that is part of a thread, no text is deleted: it is overset or it flows into the next frame in succession. If the text frame isn't connected to any other frame, the frame and text are deleted.

1. To select the text frame, do one of the following:
 - Using a selection tool, click the frame.
 - Using the Type tool, hold down Ctrl (Windows) or Command (Mac OS), and then click the frame.
2. Press Backspace or Delete.





[To the top](#)

Flow text manually or automatically

Your pointer becomes a loaded text icon  after you place text or click an in port or out port. The loaded text icon lets you flow text onto your pages. By holding down a modifier key, you can determine how the text is flowed. The loaded text icon changes appearance, depending on where it is placed.

When you position the loaded text icon over a text frame, parentheses enclose the icon . When you position the loaded text icon next to a guide or grid snapping point, the black pointer becomes white .

You can flow text using four methods:

Method	What it does
Manual text flow 	Adds text one frame at a time. You must reload the text icon to continue flowing text.
Semi-autoflow  by holding down Alt (Windows) or Option (Mac OS) when you click.	Works like manual text flow, except that the pointer becomes a loaded text icon each time the end of a frame is reached, until all text is flowed into your document.
Autoflow  by Shift-clicking.	Adds pages and frames until all text is flowed into your document.
Fixed-page autoflow  by holding down Shift+Alt (Windows) or Shift+Option (Mac OS) when you click.	Flows all text into the document, adding frames as necessary without adding pages. Any remaining text is overset.

To flow text in frames, InDesign detects horizontal or vertical type. When text is flowed with semi-automatic or automatic flow, it is flowed according to the frame type and direction set in the Story panel. The icon gives users visual feedback of which direction the text will flow.

Flow text manually

1. Use the Place command to select a file, or click the out port  of a selected text frame.
2. Do one of the following:
 - Position the loaded text icon anywhere within an existing frame or path, and then click. The text flows into the frame and any other frames linked to it. Note that text always starts filling the frame at the top of the leftmost column, even when you click in a different column.
 - Position the loaded text icon in a column to create a text frame the width of that column. The top of the frame appears where you click.
 - Drag the loaded text icon to create a text frame the width and height of the area you define.
3. If there is more text to be placed, click the out port and repeat steps 1 and 2 until all text has been placed.

Note: When you place text in a frame that is threaded to other frames, text autoflows through the threaded frames, regardless of the text flow method you choose.

Flow text semi-automatically

- With a loaded text icon, Alt-click (Windows) or Option-click (Mac OS) a page or frame.

The text flows one column at a time, as in manual flow, but the loaded text icon automatically reloads after each column is placed.

Flow text automatically

- With the loaded text icon displayed, hold down Shift as you do one of the following:
 - Click the loaded text icon in a column to create a frame the width of that column. InDesign creates new text frames and new document pages until all text is added to the document.
 - Click inside a text frame that is based on a master text frame. The text autflows into the document page frame and generates new pages as needed, using the master frame's attributes. (See [About masters, stacking order, and layers.](#))

Flow text automatically without adding pages

- With a loaded text icon, hold down Shift+Alt (Windows) or Shift+Option (Mac OS).

[To the top](#)

Use Smart Text Reflow

You can use the Smart Text Reflow feature to add or remove pages when you're typing or editing text. This feature is useful when you're using InDesign as a text editor and you want a new page to be added whenever you type more text than can fit on the current page. It's also useful in avoiding overset text or empty pages for situations in which the text flow changes due to editing text, showing or hiding conditional text, or making other changes to the text flow.

By default, Smart Text Reflow is limited to master text frames — text frames that are on a master page. If the document includes facing pages, master text frames must appear on both left and right master pages, and the master text frames must be threaded for Smart Text Reflow to work.

You can change settings to allow pages to be added or removed when working in text frames that aren't based on master pages. However, a text frame must be threaded to at least one other text frame on a different page for Smart Text Reflow to work.

Smart Text Reflow settings appear in Type preferences. These settings apply to the current document. To change default settings for all new documents, close all documents and specify the settings.

1. Choose Edit > Preferences > Type (Windows) or InDesign > Preferences > Type (Mac OS).
2. Select Smart Text Reflow.
3. Select any of the following options and then click OK.

Add Pages To Use this option to determine where the new page is created. For example, suppose you have a three-page document with text frames on the first two pages and a full-page graphic on the third page. If you're typing to the end of page two, you can determine whether the new page is added before or after the full-page graphic on the third page. Choose End Of Story to add a new page after the second page. Choose End Of Document to add a new page after the page with the full-page graphic.

In a document with multiple sections, you can choose End Of Section to add the page at the end of the section.

Limit To Master Text Frames If this option is turned off, you can also add or remove pages when editing text frames that aren't based on master pages. To prevent unwanted text reflow from occurring, Smart Text Reflow takes effect only if the text frame you're editing is threaded to at least one other text frame on a different page.

note: *When using Smart Text Reflow in text frames that aren't based on master pages, pages are added with full-page, single-column text frames, regardless of the attributes of the text frame to which the new frame is threaded.*

Preserve Facing-Page Spreads This option determines whether facing-page spreads are preserved when text is reflowed in the middle of a document. If this option is selected when text reflows in the middle of the document, a new two-page spread is added. If this option is not selected, a single new page is added, and subsequent pages are "shuffled."

If your layout includes design elements specific to the right or left side of the spread, turn on this option. If your left and right pages are interchangeable, you can turn off this option. This option is dimmed if the document does not have facing pages.

Delete Empty Pages Select this option to delete pages when you edit text or hide conditions. Pages are deleted only if the emptied text frame is the only object on the page.

 *To see how Smart Text Reflow can let you use InDesign as a text editor, create a document with Facing Pages turned off and Master Text Frame selected. In Type preferences, make sure that Smart Text Reflow and Delete Empty Pages are selected. On the first page, hold down Ctrl+Shift (Windows) or Command+Shift (Mac OS), and click the master text frame to override it. When you type enough text to fill this text frame, a new page and text frame is added automatically. If you delete enough text, a page is removed.*

 Twitter™ and Facebook posts are not covered under the terms of Creative Commons.

[Legal Notices](#) | [Online Privacy Policy](#)

Wrapping text around objects

- [Wrap text around objects](#)
- [Change the shape of a text wrap](#)
- [Apply text wrap on master page items](#)
- [Wrapping text around anchored objects](#)
- [Suppress text wrap on hidden layers](#)
- [Justify text next to wrap objects](#)
- [Ignore text wrap in a text frame](#)

[To the top](#)



Wrap text around objects

You can wrap text around any object, including text frames, imported images, and objects you draw in InDesign. When you apply a text wrap to an object, InDesign creates a boundary around the object that repels text. The object that text wraps around is called the *wrap object*. Text wrap is also referred to as *runaround text*.

Keep in mind that text wrap options apply to the object being wrapped, not the text itself. Any change to the wrap boundary will remain if you move the wrap object near a different text frame.

InDesign Magazine provides an article about text wrap at [Take Control of Text Wrap](#).

Wrap text around simple objects

1. To display the Text Wrap panel, choose Window > Text Wrap.
2. Using the Selection tool  or Direct Selection tool , select the object you want to wrap text around.
3. In the Text Wrap panel, click the desired wrap shape:

Wrap Around Bounding Box

Creates a rectangular wrap whose width and height are determined by the bounding box of the selected object, including any offset distances you specify.

Wrap Around Object Shape

Also known as *contour wrapping*, creates a text wrap boundary that is the same shape as the frame you've selected (plus or minus any offset distances you specify).



Wrap Around Bounding Box setting (left) compared to Wrap Around Object Shape setting (right)

Jump Object

Keeps text from appearing in any available space to the right or left of the frame.

Jump To Next Column

Forces the surrounding paragraph to the top of the next column or text frame.

4. From the Wrap To menu, specify whether the wrap is applied to a specific side (such as the right side or largest area) or towards or away from the spine. (If you don't see the Wrap To menu, choose Show Options from the Text Wrap panel menu.)

This option is available only if you selected Wrap Around Bounding Box or Wrap Around Object Shape.

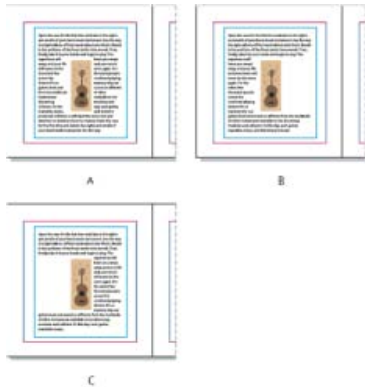

Wrap To options

A. Both right and left sides **B.** Side towards spine **C.** Side away from spine

5. Specify offset values. Positive values move the wrap away from the frame; negative values move the wrap within the frame.

If you can't get the text to wrap around an image, make sure that Ignore Text Wrap isn't selected for the text frame that doesn't wrap. Also, if Text Wrap Only Affects Text Beneath is selected in Composition preferences, make sure that the text frame is beneath the wrap object.

Text frames inside a group aren't affected by a text wrap you apply to the group.

 *To set default text wrap options for all new objects, deselect all objects and then specify text wrap settings.*

Wrap text around imported images

To wrap text around an imported image, save the clipping path in the application where you created the image, if possible. When you place the image in InDesign, select the Apply Photoshop Clipping Path option in the Image Import Options dialog box.

1. To display the Text Wrap panel, choose Window > Text Wrap.
2. Select an imported image, and in the Text Wrap panel, click Wrap Around Object Shape .
3. Specify offset values. Positive values move the wrap away from the frame; negative values move the wrap within the frame.
4. Choose Show Options from the Text Wrap panel menu to display additional options.
5. From the Type menu, choose a contour option:

Bounding Box

Wraps text to the rectangle formed by the image's height and width.

Detect Edges

Generates the boundary using automatic edge detection. (To adjust edge detection, select the object and choose Object > Clipping Path > Options.)

Alpha Channel

Generates the boundary from an alpha channel saved with the image. If this option isn't available, no alpha channels were saved with the image. InDesign recognizes the default transparency in Adobe Photoshop (the checkerboard pattern) as an alpha channel; you must otherwise use Photoshop to delete the background or create and save one or more alpha channels with the image.

Photoshop Path

Generates the boundary from a path saved with the image. Choose Photoshop Path, and then choose a path from the Path menu. If the Photoshop Path option isn't available, no named paths were saved with the image.

Graphic Frame

Generates the boundary from the container frame.

Same As Clipping

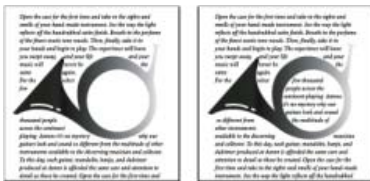

Generates the boundary from the imported image's clipping path.

6. To let text appear inside "holes" of an image, such as the inside of a tire image, select Include Inside Edges.



Include Inside Edges off (left) and on (right)

Create an inverted text wrap

1. Using the Selection tool  or Direct Selection tool , select an object, such as a compound path, that will allow text to wrap inside it.
2. To display the Text Wrap panel, choose Window > Text Wrap.
3. Apply a text wrap to an object, and select the Invert option. Invert is commonly used with the Object Shape text wrap.

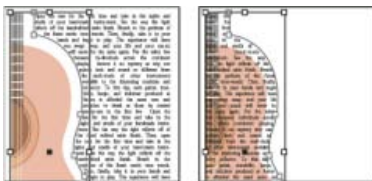

Object Shape text wrap (left) and with Invert option selected (right)

[To the top](#)

Change the shape of a text wrap

1. Using the Direct Selection tool , select an object that has a text wrap applied to it. If the text wrap boundary is the same shape as the object, the boundary is superimposed on the object.
2. Do any of the following:

- To uniformly change the distance between the text and wrap object, specify offset values in the Text Wrap panel.
- To edit the text wrap boundary, use the Pen tool  and Direct Selection tool.

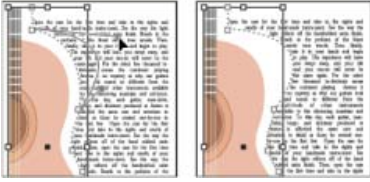

Editing text wrap boundary

If you manually change the shape of a text wrap path, User-Modified Path is selected in the Type menu and remains dimmed in the menu. This indicates that the path of the shape has changed.

 *If you want to use the original clipping path rather than the edited text wrap boundary, choose Same As Clipping from the Type menu in the Text Wrap panel.*

[To the top](#)

Apply text wrap on master page items

If the Apply To Master Page Only option is selected, you must override a master page item on a document page to wrap text around it. If this option is deselected, text on both master pages and document pages can wrap around the master page items without the master page items being overridden.

1. Select the object on the master page.
2. From the Text Wrap panel menu, select or deselect Apply To Master Page Only.

This option is available only when an object on a master page is selected and has a wrap applied to it.

[To the top](#)

Wrapping text around anchored objects

If you apply text wrap to an anchored object, the wrap affects the lines of text in the story that follow the anchor marker. However, the wrap doesn't affect the line of text that includes the anchor marker or any lines before it.

When you paste an object as an inline object, its text wrap boundaries are preserved.

[To the top](#)

Suppress text wrap on hidden layers

When you hide a layer that contains a wrap object, the text frames on other layers wrap around the object, unless you select the Suppress Text Wrap When Layer Is Hidden option in the Layer Options dialog box. If this option is selected, hiding a layer can cause text on other layers to be recomposed.

1. In the Layers panel, double-click the layer that contains the wrap object.
2. Select Suppress Text Wrap When Layer Is Hidden.

Justify text next to wrap objects

When you specify how text is justified next to wrap objects, the change applies to the entire document.

1. Choose Edit > Preferences > Composition (Windows) or InDesign > Preferences > Composition (Mac OS).
2. Select one of the following options, and click OK:

Justify Text Next To An Object

Justifies text next to wrap objects that separate a column of text. This setting takes effect only when the text wrap completely interrupts lines of text so that each line is divided into two or more parts.

Note: Text adjacent to an object is aligned to the left or top of the object when set to *Align Left*, to the right or bottom of the object when set to *Align Right*, or evenly aligned to both edges when set to *Full Justify*.

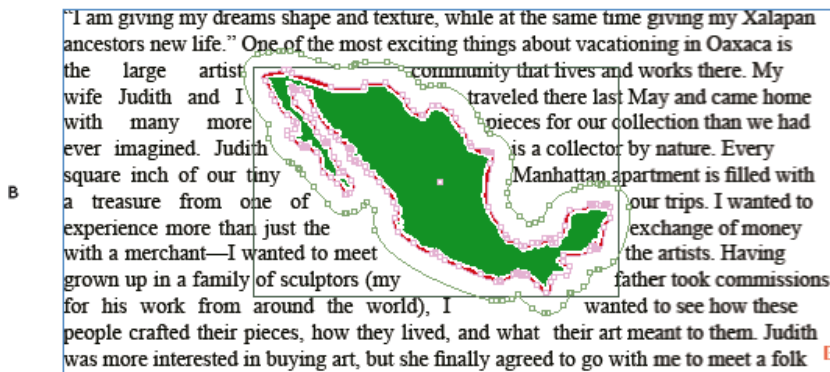
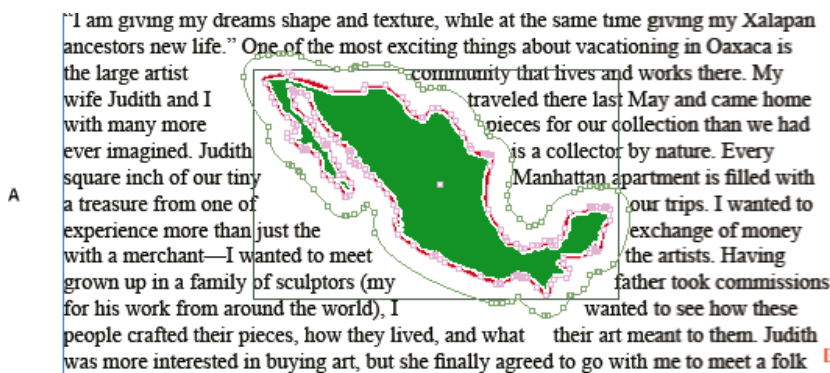

Justify Text Next To An Object

Skip By Leading

Moves wrapped text to the next available leading increment below a text-wrapped object. If this option isn't selected, lines of text may jump below an object in a way that prevents text from lining up with text in neighboring columns or text frames. Selecting this option is especially useful when you want to make sure that the text aligns to the baseline grid.

Text Wrap Only Affects Text Beneath

Text stacked above the wrapped object isn't affected by the text wrap. Stacking order is determined by layer position in the Layers panel and by the stacking order of objects on a layer.

Ignore text wrap in a text frame

In some cases, you'll want to turn off text wrap in a text frame. For example, you may want one text frame to wrap around an image, but you may want a different text frame to appear within the image.

1. Select the text frame, and choose Object > Text Frame Options.

2. Select Ignore Text Wrap, and click OK.

- [Compound paths and shapes](#)
- [About masks and alpha channels](#)
- [Master pages](#)

 Twitter™ and Facebook posts are not covered under the terms of Creative Commons.

[Legal Notices](#) | [Online Privacy Policy](#)

Arabic and Hebrew features | CC, CS6

[Adobe World-Ready Composers](#)

[Text direction](#)

[Story direction](#)

[Automatic Kashida insertion](#)

[Ligatures](#)

[Diacritical marks](#)

[Copy-paste from Microsoft Word](#)

[Default fonts](#)

[Legacy font support](#)

[Digit Types](#)

[Hyphenation](#)

[Find and replace](#)

[Glyphs](#)

[Justification Alternates](#)

[Special Middle East characters insertion](#)

[Table direction](#)

[Binding directions](#)

[Right to Left writing preferences](#)

[Page and chapter numbering](#)

[Writing direction in Gallery view and Story Editor](#)

[Diacritical coloring](#)

New and improved features for working in Arabic and Hebrew are available in the Middle East and North African edition of this software.

[To the top](#)

Adobe World-Ready Composers

Adobe World-Ready composers enable you to create content in middle-eastern languages. You can type in, and mix between, Arabic, Hebrew, English, French, German, Russian, and other Latin languages.

You can choose between available composers from the Paragraph panel menu (Windows > Paragraph > panel menu). For example, in InDesign, you can use the Adobe World-Ready Paragraph Composer. Or, in Illustrator, you can use the Middle Eastern Single-line Composer.

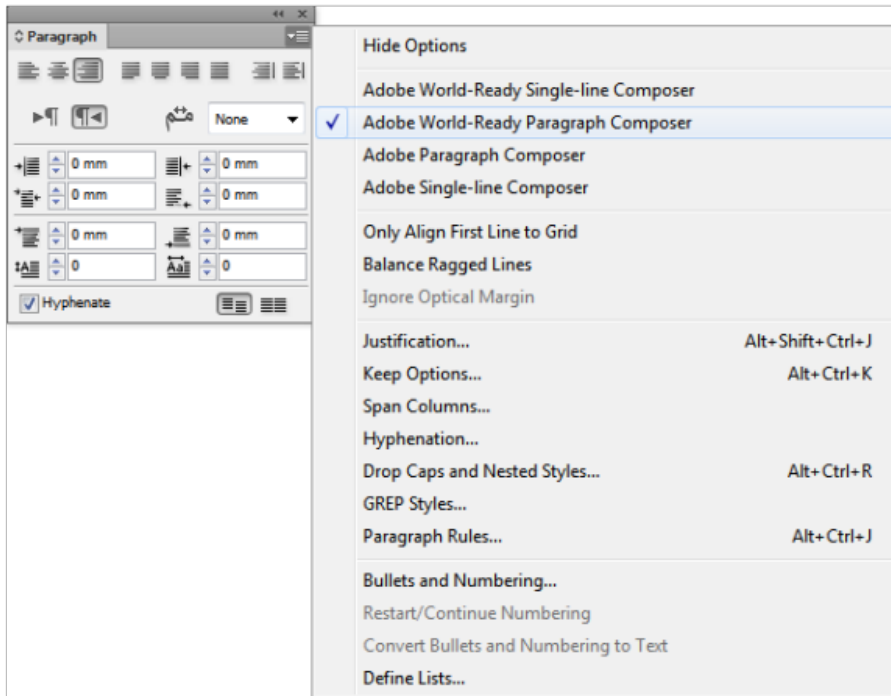

Adobe World-Ready Composers

You can also save your files with Arabic and Hebrew names.

[To the top](#)

Text direction

To create content in Arabic and Hebrew, you can make the right-to-left (RTL) direction the default text direction. However, for documents that include left-to-right (LTR) text, you can now seamlessly switch between the two directions.

Select the paragraph direction from the Paragraph panel.

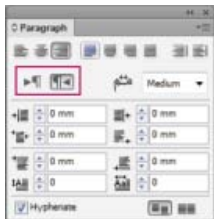

Paragraph direction selection

If you have a mix of languages in the same paragraph, you can specify the direction of text at a character level. Also, to insert dates or numbers, specify the direction of text at the character level.

From the Character panel menu, choose Character Direction and then select a direction.

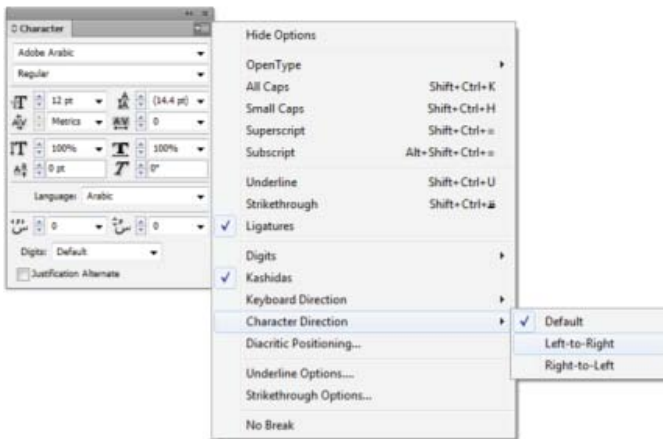

Character direction

[To the top](#)

Story direction

When you're working with Arabic and Hebrew languages, the story generally flows from the right to the left. The first column must be on right side of the frame, and subsequent columns are added to the left. If your layout contains mixed content, then different stories need a different direction.

From the Story panel (Window > Type & Tables > Story), click a story direction.



Story direction

[To the top](#)

Automatic Kashida insertion

In Arabic, text is justified by adding Kashidas. Kashidas are added to arabic characters to lengthen them. Whitespace is not modified. Use automatic Kashida insertion to justify paragraphs of arabic text.

Select the paragraph and from the Paragraph panel (Window > Type & Tables > Paragraph), choose a setting from the Insert Kashida drop-down list. The options available are: None, Short, Medium, Long, or Stylistic. Kashidas are only inserted if the paragraph is justified. This setting is not applicable for paragraphs that have alignment settings.

To apply Kashidas to a group of characters, select the characters and choose Kashidas from the Character panel menu.

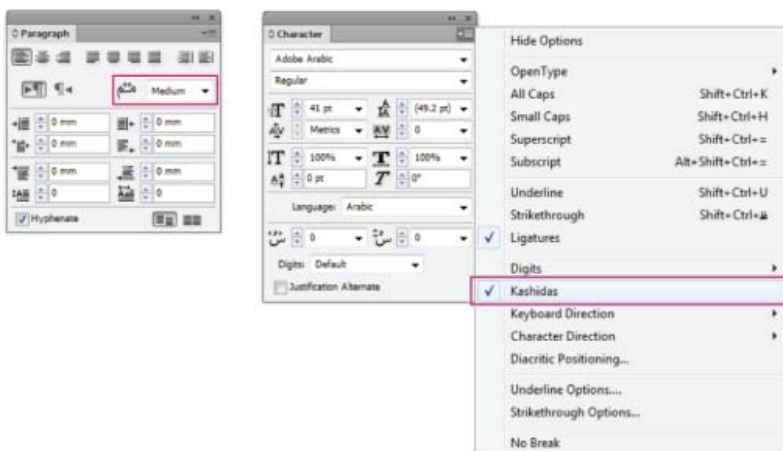

Ligatures

You can automatically apply ligatures to character pairs in Arabic and Hebrew. Ligatures are typographic replacement characters for certain letter pairs if they are available in a given Open Type font.

When you choose Ligatures from the Character panel menu or Control panel menu, a standard ligature defined in the font is produced.

1. Select text.
2. Choose Ligatures from the Character panel menu or the Control panel menu.

However, some Open Type fonts include more ornate, optional ligatures, which can be produced when you choose Discretionary Ligatures. These ligatures are found at Character panel > OpenType > Discretionary Ligatures.

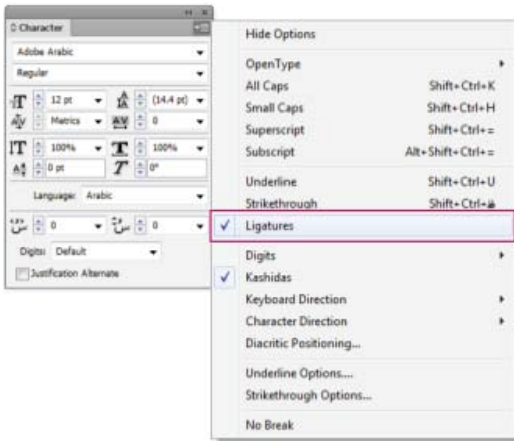

Enable automatic ligatures

Diacritical marks

In the Arabic script, a diacritic or a diacritical mark is a glyph used to indicate consonant length or short vowels. A diacritical mark is placed above or below the script. For better styling of text, or improved readability of certain fonts, you can control the vertical or horizontal position of diacritical marks:

1. Select text that has diacritical marks
2. In the Character panel, modify the position of the diacritic marks relative to the script. Values you can change are, Adjust Horizontal Diacritic Position, and the Adjust Vertical Diacritic Position.

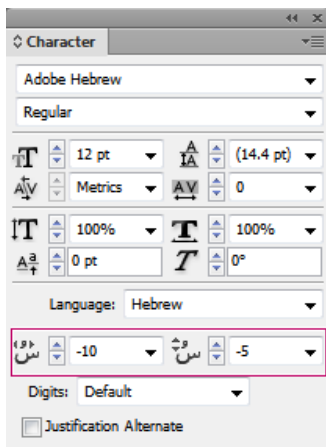

Change the position of diacritical marks

[To the top](#)

Copy-paste from Microsoft Word

You can copy text from Microsoft Word, and paste it directly into a document. The pasted text's alignment and direction is automatically set to that of the arabic or hebrew text.

[To the top](#)

Default fonts

When you install a Middle Eastern or North African version, the default typing font is set to the installation-specific language, by default. For example, if you have installed the English/Arabic-enabled version, the default typing font is set to Adobe Arabic. Similarly, if you have installed the English/Hebrew-enabled version, the default typing font is set to Adobe Hebrew (or Myriad Hebrew in Photoshop).

[To the top](#)

Legacy font support

Fonts that have been traditionally used (for example, AXT fonts) can continue to be used in this release of the software. However, it is recommended that newer Open Type fonts be used for text-based elements.

Missing Glyph Protection (Edit > Preferences > Advanced Type) is enabled by default. Text is handled automatically, where glyphs are not available in the font you are using.

[To the top](#)

Digit Types

When you are working in Arabic or Hebrew, you can select the type of digits you want to use. You can choose between Arabic, Hindi, and Farsi. By default, in Arabic, the Hindi version is auto-selected, and in case of Hebrew, the Arabic type digits are selected. However, you can switch to Arabic digits, if necessary:

1. Select the digits in the text typed.
2. In the Character panel (Ctrl + T), use the Digits list to select the font that the digits must appear in.

You can ensure that Arabic digits are used by enabling the Use Native Digits when typing in Arabic Scripts option. To use this option, choose Edit > Preferences > Advanced Type.

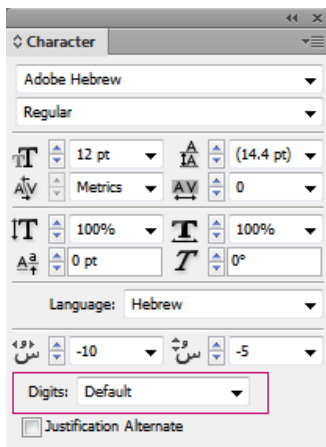

Digit type selection

[To the top](#)

Hyphenation

Sentences that have more words that can fit into one line of text automatically wrap into the next line. The type of text justification when wrapping occurs sometimes causes unnecessary spaces to appear in the line that are not aesthetically pleasing or linguistically correct. Hyphenation enables you to split the word at the end of a line, using a hyphen. This fragmentation causes the sentence to wrap into the next line in a better way.

Mixed text: The Kashida insertion feature affects how hyphenation occurs in mixed text. When enabled, Kashidas are inserted where applicable, and non-Arabic text is not hyphenated. When the Kashida feature is disabled, only non-Arabic text is considered for hyphenation.

Hebrew text: Hyphenation is allowed. To enable hyphenation and customize settings, choose Paragraph panel > Panel menu > Hyphenation Settings.

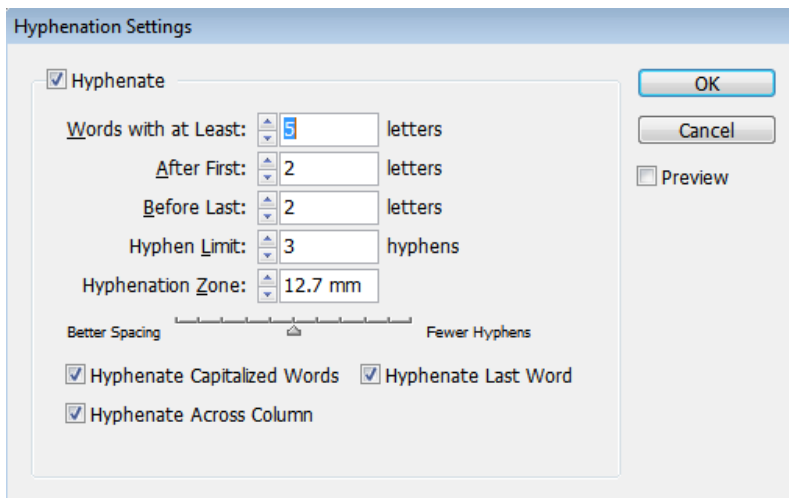

Hyphenation options

[To the top](#)

Find and replace

Arabic and Hebrew users can perform full text search and replace. In addition to searching and replacing simple text, you can also search and replace text with specific characteristics. These characteristics can include diacritical marks, Kashidas, special characters (for example, Alef), digits in different languages (for example, digits in Hindi), and more.

To perform text find-and-replace:

- **InDesign:** Edit > Find/Change

In InDesign, you can use the Transliterate tab (Edit > Find/Change) to find and replace digits between Arabic, Hindi, and Farsi. For example, you can find digits typed in Hindi and convert them to Arabic.

[To the top](#)

Glyphs

Arabic and Hebrew users can apply glyphs from the default character set. However, to browse, select, and apply a glyph from the default character set or a different language set, use the Glyphs panel:

- **InDesign:** Window > Type & Tables > Glyphs
- **Illustrator:** Window > Type > Glyphs

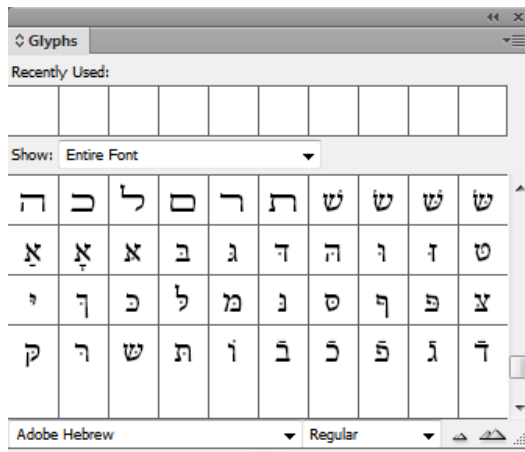

Browse, select, and apply glyphs

[To the top](#)

Justification Alternates

A font can have alternative shapes of certain letters of the alphabet. These variations of the font face for some letters are generally available for stylistic or calligraphy purposes. In rare cases, justification alternates are used to justify and align paragraphs for specific needs.

Justification alternates can be turned on at a paragraph level, where alternates are used wherever possible. You can also turn on or off this feature at a character level. Justification alternates are available only in those fonts that have this feature integrated. Therefore, the option to turn them on or off is available only for supported fonts.

Arabic fonts that contain justification alternates: Adobe Arabic, Myriad Arabic, and Adobe Naskh. Hebrew fonts that contain justification alternates: Adobe Hebrew and Myriad Hebrew.

- **InDesign**

Paragraph-level: Window > Paragraph panel > panel menu > Justification, and then choose an option from the Justification list.

Character-level: Window > Character panel > panel menu > Justification Alternate option.

- **Photoshop**

Character-level: Window > Character panel > Justification Alternates checkbox.

[To the top](#)

Special Middle East characters insertion

Some characters in Arabic and Hebrew are difficult to insert in text. Also, Arabic and Hebrew keyboard layouts make it difficult to type or include these characters. To insert characters like a Hebrew apostrophe (Geresh) or Maqaf, select a character from Character panel > panel menu >

Insert Special ME Character.

Insert Special Character	▶	
Insert Special ME Character	▶	Geresh
Insert White Space	▶	Gershayim
Insert Break Character	▶	Maqaf
Fill with Placeholder Text		Sof Pasuk
Tag Text	▶	Kashida
Autotag	Alt+Shift+Ctrl+F7	Dotted Circle
Interactive	▶	Left to Right Dash
Edit in Story Editor	Ctrl+Y	Right to Left Dash
InCopy	▶	Unicode Markers ▶

Insert a special ME character

[To the top](#)

Table direction

Arabic and Hebrew users can set the direction of a table inserted in a document. Accordingly the order of cells and columns, default language, and the alignment of text is set. For an Arabic user, the rightmost column is the first column, and any additional columns are added beyond the leftmost column of the table. Table direction is also supported in the Story Editor (Ctrl + Y).

To set the direction of a new table:

1. Click Table > Insert Table
2. In the Insert Table dialog box, choose from the Direction list to select the table direction.

To change the direction of an existing table:

1. Place the cursor inside a table
2. Open the Table panel (Shift + F9), and click the Left-to-Right Table or Right-to-Left Table icons to set the direction of the table.

For Right-to-Left tables, the Arabic and North African versions default to Arabic language. The Hebrew version is set to Hebrew language. For Left-to-Right tables, the Arabic and Hebrew versions default to English language. The North African version defaults to French.

[To the top](#)

Binding directions

Binding direction determines the edge along which a book is bound. Books written in a left-to-right language are left-bound. Documents written in right-to-left language are bound along the rightmost edge of the book.

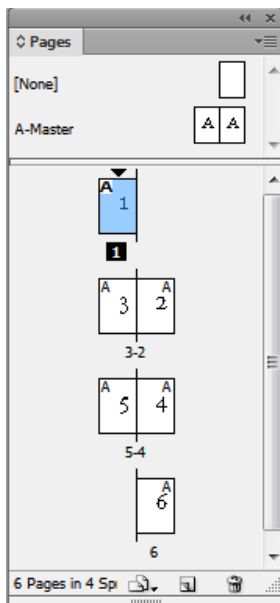

Page layout of a right-bound book

[To the top](#)

Right to Left writing preferences

Neutral characters

The direction of some characters in Arabic and Hebrew can appear ambiguous. Lack of clarity about the direction of characters can cause confusion in the direction and order of strings. To ensure that the direction of such characters is clear and unambiguous:

1. Click Edit > Preferences > Right to Left
2. Select the Force Neutral Character Direction According to the Keyboard Input box.

Cursor Control

Arabic and Hebrew users can control the direction that the cursor moves, when they use the arrow keys on the keyboard. This Cursor Movement list (Edit > Preferences > Right to Left) has two options that you can choose from:

- **Visual:** The cursor moves in the direction of the arrow key. When the right arrow is pressed, the cursor on the screen moves to the right.
- **Logical:** The cursor moves according to the direction of the language typed. In Arabic and Hebrew, when the right arrow is pressed, the cursor moves left (to the next character in a right to left language).

[To the top](#)

Page and chapter numbering

Arabic and Hebrew users use the most commonly preferred numbering systems in the region. The most popular numbering systems are:

- **Arabic:** Arabic Abjad and Alef-Ba-Tah
- **French:** Hebrew Biblical Standard and Hebrew Non-Standard Decimal

To select or change the numbering system, go to Layout > Numbering & Section Options, and then select from the Style list.

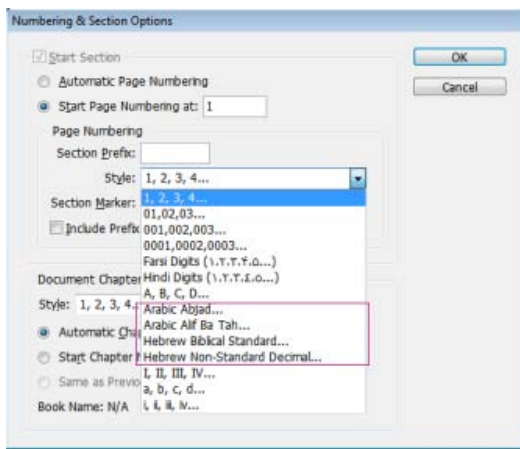

Numbering pages, sections, and chapters

[To the top](#)

Writing direction in Gallery view and Story Editor

While in Arabic or Hebrew, you can indicate the direction in which you are writing. Go to Edit > Preferences > Story Editor Display, and select the Indicate Writing Direction box, to enable this feature. When this feature is enabled, the cursor has an arrow that indicates the direction of writing.

[To the top](#)

Diacritical coloring

In Arabic text, diacritical marks can be colored differently for stylistic or other purposes. For example, diacritical marks can be lay emphasis on a particular aspect of a word or sentence. You can find and change the color of diacritical marks using the Change Arabic Diacritic Color query.

1. Click Edit > Find/Change
2. From the Query list, select Change Arabic Diacritic Color
3. Use the Change, Change All, or Change/Find buttons to replace older diacritical marks with the new colored diacritical marks.

You can modify and save the query as per your requirements.

 Twitter™ and Facebook posts are not covered under the terms of Creative Commons.

[Legal Notices](#) | [Online Privacy Policy](#)

Text Frame fitting options | CC, CS6

Flexible width columns
Persistent text frame fitting options

[To the top](#)

Flexible width columns

You can use the Flexible width option to adjust the number and width of columns as the text frame is resized. Columns are automatically added or deleted when the maximum column width is reached as the text frame is resized.



A. Original text frame B. Text frame width increases C. Column added to the Text Frame

Choose **Flexible Width** from the Columns drop down list in the **Text Frame Options** dialog box (**Object > Text Frame Options**)

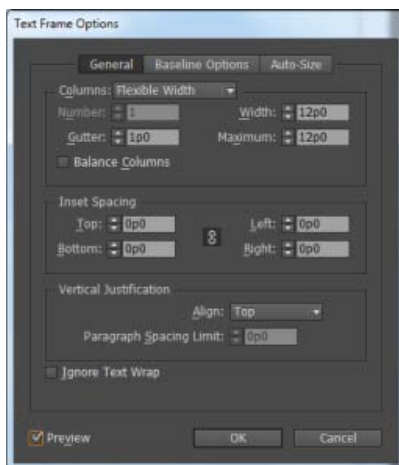

Flexible width columns

[To the top](#)

Persistent text frame fitting options

Auto-size text frame options make it possible to set up a text frame so that it is automatically resized when you add, delete, or edit text. To access the Auto-size options, do the following:

1. Select a text frame and choose **Object > Text Frame Options**
2. Click **Auto-size**.

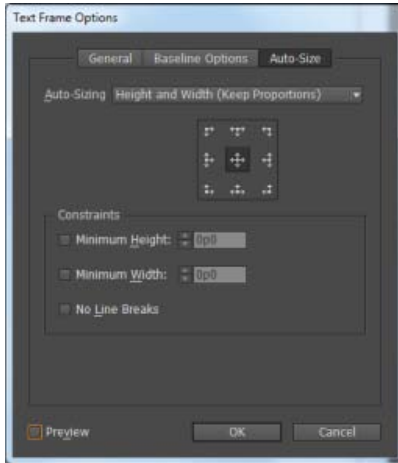

Auto Size options

3. Select an auto size option to apply when text is added or deleted:
 - Off
 - Height only
 - Width only
 - Height and Width
 - Height and Width (Keep proportions)
4. From the anchor proxy, click a reference location to resize from. The anchor proxy also indicates how the text frame resizes.
5. Specify the constraints for minimum height and weight, and line breaks.

 Twitter™ and Facebook posts are not covered under the terms of Creative Commons.

[Legal Notices](#) | [Online Privacy Policy](#)

Spell-checking and language dictionaries

[Check spelling](#)
[Hyphenation and spelling dictionaries](#)

[To the top](#)

Check spelling

You can spell-check a selected range of text, in all of the text in a story, in all stories in a document, or in all stories in all open documents. Misspelled or unknown words, words typed twice in a row (such as “the the”), and words with possible capitalization errors are highlighted. In addition to checking the spelling in a document, you can also enable dynamic spelling so that potentially misspelled words are underlined while you type.

When you check spelling, the dictionary for the languages you assigned to the text is used. You can quickly add words to the dictionary.

Set spelling preferences

1. Choose Edit > Preferences > Spelling (Windows) or InDesign > Preferences > Spelling (Mac OS).
2. Do any of the following:
 - Select Misspelled Words to find words that do not appear in the language dictionary.
 - Select Repeated Words to find duplicate words such as “the the.”
 - Select Uncapitalized Words to find words (such as “germany”) that appear in the dictionary only as capitalized words (“Germany”).
 - Select Uncapitalized Sentences to find uncapitalized words following periods, exclamation points, and question marks.
3. Select Enable Dynamic Spelling to underline potentially misspelled words while you type.
4. Specify the underline color of misspelled words (words not found in the user dictionaries), repeated words (such as “the the”), uncapitalized words (such as “nigeria” instead of “Nigeria”), and uncapitalized sentences (sentences that don’t begin with a capital letter).

Check spelling

1. If your document includes foreign-language text, select the text and use the Language menu on the Character panel to specify the language for that text.
2. Choose Edit > Spelling > Check Spelling.

Spell-checking begins.

3. If you want to change the range of your spell-checking, do any of the following, and then click Start to begin checking the spelling:
 - Select Document to check the entire document. Select All Documents to check all open documents.
 - Select Story to check all text in the currently selected frame, including text in other threaded text frames and overset text. Select Stories

to check stories in all selected frames.

- Select To End Of Story to check from the insertion point.
- Select Selection to check only selected text. This option is available only if text is selected.

4. When unfamiliar or misspelled words or other possible errors are displayed, choose an option:

- Click Skip to continue spell-checking without changing the highlighted word. Click Ignore All to ignore all occurrences of the highlighted word, until InDesign is restarted.
- Select a word from the Suggested Corrections list or type the correct word in the Change To box, and then click Change to change only that occurrence of the misspelled word. You can also click Change All to change all occurrences of the misspelled word in your document.
- To add a word to a dictionary, select the dictionary from the Add To menu, and click Add.
- Click Dictionary to display the Dictionary dialog box, where you can specify the target dictionary and language, and specify hyphenation breaks in the added word. If you want to add the word to all languages, choose All Languages from the Language menu. Click Add.

Correct spelling errors as you type

By turning on Autocorrect, you can allow capitalization errors and common typing mistakes to be replaced while you type. Before Autocorrect will work, you must create a list of commonly misspelled words and associate them with the correct spelling.

1. Choose Edit > Preferences > Autocorrect (Windows) or InDesign > Preferences > Autocorrect (Mac OS).
2. Choose Enable Autocorrect. (You can also choose Edit > Spelling > Autocorrect to turn this feature on or off quickly.)
3. From the Language menu, choose which language the autocorrections are applied to.
4. To correct capitalization errors (such as typing “germany” instead of “Germany”), select Autocorrect Capitalization Errors. You don’t need to add the capitalized words to the list of autocorrections.
5. To add a word that you commonly misspell, click Add, type the misspelled word (such as “teh”), type the correction (such as “the”), and then click OK.
6. Continue to add words that you commonly misspell, and then click OK.

When you type any misspelled word you added to the list, the word is automatically replaced by the word you entered as the correction.

To remove autocorrect words you’ve added, select the word in the list and choose Remove. To edit autocorrect words, select the word, click Edit, retype the correction, and click OK.

Use dynamic spelling

When dynamic spelling is enabled, you can correct spelling errors by using the context menu. Potentially misspelled words are underlined (based on the dictionary associated with the language of the text). If you type text in different languages, select the text and assign the correct language.

1. To enable dynamic spelling, choose Edit > Spelling > Dynamic Spelling.

Potentially misspelled words are underlined in your document.

2. Right-click (Windows) or Control-click (Mac OS) the underlined word, and do one of the following:

- Select a suggested correction. If a word is repeated or needs to be capitalized, you can choose Delete Repeated Word *[word]* or Capitalize *[word]*.
- Select Add *[word]* To User Dictionary. This automatically adds the word to the current dictionary without opening the Dictionary dialog box. The word remains unchanged in the text.
- Select Dictionary. This opens the Dictionary dialog box where you can select the Target dictionary, change hyphenation breaks, and specify a language. If you want to add the word to all languages, choose All Languages from the Language menu, and then click Add. The word is added to the selected dictionary and remains unchanged in the text.
- Select Ignore All to ignore occurrences of this word in all documents. When InDesign is restarted, the word is flagged again as a misspelling.

Note: If you select Ignore All and then decide that you don't want to ignore that word after all, Choose Ignored Words from the Dictionary List menu in the Dictionary dialog box and remove the word from the list.

[To the top](#)

Hyphenation and spelling dictionaries

InDesign uses Proximity dictionaries for most languages to verify spelling and to hyphenate words. You can add words to each dictionary to customize it. You can assign different languages to text, and InDesign uses the appropriate dictionary to handle spelling and hyphenation. You can create additional user dictionaries, and you can import or export word lists saved in a plain text file.

When you customize the words in a dictionary, you actually create lists of *added words* (words that aren't already in the dictionary) and *removed words* (existing dictionary words that you want to be flagged as a potential misspelling). The Dictionary dialog box lets you display and edit added words, removed words, and *ignored words* (words that are ignored for the current session because you clicked Ignore All). You can add words that apply to all languages, which is especially useful for last names, street names, and other items that aren't specific to a language.

 If you want to use the language dictionaries from a previous version of InDesign or InCopy, use your system Find command to locate the user dictionary files (.udc), and then add them to your list of dictionaries in Dictionary preferences.

Where dictionary words are stored

By default, hyphenation and spelling exceptions are located in user dictionary files stored outside the document on the computer where InDesign is installed (dictionary file names end with a .clam or .not extension). However, you can also store exception lists inside any InDesign document. In addition, you can store word lists in an external user dictionary, in the document, or in both. The location of existing dictionaries appears in the Dictionary preferences.

Storing hyphenation and spelling exceptions inside a document makes it easier to treat text consistently when you move that document to other computers. For this reason, you can merge the user dictionary into the document in Dictionary preferences. You can also control the location of exceptions from the Create Package Folder dialog box (see Package files). In contrast, storing an exception list outside the document makes it easier to use the same list of exceptions for multiple documents.

Note: If the user dictionary is merged into the exceptions list, the entire user dictionary is added to the document, even if the words are not used, thereby increasing the document's file size.

Applying languages to text



You can use the Language menu in the Character panel to apply a language to selected text. You can also specify a default language for an entire document, or for all new documents. InDesign also includes a language locking feature that prevents the language setting in Asian text from being changed when it is part of a selection and a non-Asian language is chosen from the Language menu. (See Assign a language to text.)

Exception word lists

You can exclude words from being considered. For example, if you want to use an alternate spelling for a common word such as "bicycle," which you may need to spell in a different way for your company name or for a specific document, add the word to the list of excluded words so that it will be flagged during a spell check. InDesign can maintain a separate set of added and removed words for each installed language.

Create or add user dictionaries

You can create a user dictionary, or you can add user dictionaries from previous InDesign or InCopy versions, from files that others have sent you, or from a server where your workgroup's user dictionary is stored. The dictionary you add is used for all your InDesign documents.

1. Choose Edit > Preferences > Dictionary (Windows) or InDesign > Preferences > Dictionary (Mac OS).
2. From the Language menu, choose the language with which you want to associate the dictionary.
3. Do one of the following:
 - To create a new dictionary, click the New User Dictionary icon  below the Language menu. Specify the name and location of the user dictionary (which includes a .udc extension), and then click Save.
 - To add an existing dictionary, click the Add User Dictionary icon , select the user dictionary file, which includes a .udc or .not extension, and then click Open.

Note: If you can't find the dictionary file, you might want to use your system Find command to locate the .udc files (try using *.udc), note the location, and then try again.

The dictionary is added to the list under the Language menu. You can add words to the dictionary when checking spelling or by using the Dictionary dialog box.

Set the default language dictionary for the current document

You can change the default language dictionary for a document or for all new documents you create. Changing the default dictionary in an existing document doesn't affect text that has already been created or text that you type into an existing text frame.



 Use the Character Style or Paragraph Style panel to set a specific dictionary for a specific style. The Language menu appears in the Advanced Character Formats section.

1. Open the document.
2. Select the Selection tool from the toolbar and make sure no items are selected in the document.
3. Choose Type > Character.
4. Choose the desired dictionary from the Language menu on the Character panel. If you cannot see the language option in the Character panel, select Show Options and then select your language from the list.

Set the default language dictionary for all new documents

1. Start InDesign, but do not open a document.
2. Choose Type > Character.
3. Choose the desired dictionary from the Language pop-up menu on the Character panel. If you cannot see the language option in the Character panel, select Show Options and then select your language from the list.

Remove, relink, and reorder user dictionaries

1. Choose Edit > Preferences > Dictionary (Windows) or InDesign > Preferences > Dictionary (Mac OS).
2. From the Language menu, choose the language to which the dictionary belongs.
3. Do any of the following:
 - To remove a dictionary from the list, select it and click the Remove User Dictionary icon . You must have at least one dictionary per language.
 - If the language dictionary includes a question mark icon next to it, select the dictionary, click the Relink User Dictionary icon , and then locate and open the user dictionary.
 - To change the order of the user dictionaries, drag and drop them. The order of the dictionaries in the list is the order in which the dictionaries are checked.

Add words to dictionaries

If, during a spell check, InDesign displays an unfamiliar word in the Check Spelling dialog box, select the dictionary from the Add To menu, and then click Add. You can also use the Dictionary dialog box to let you specify the target dictionary and language, and to indicate how words are added to an exception word list.

1. Choose Edit > Spelling > User Dictionary.
2. In the Language menu, choose a language. Each language contains at least one dictionary. If you want the word to be added to all languages, choose All Languages.
3. In the Target menu, choose the dictionary where you want to store the word. The Target menu lets you store the changes in an external user dictionary or in any open document.
4. In the Dictionary List menu, choose Added Words.
5. In the Word box, type or edit the word to be added to the word list.
6. Click Hyphenate to see the word's default hyphenation. Tildes (~) indicate possible hyphenation points.
7. If you don't like the hyphenation points, follow these guidelines to indicate your preferred hyphenation of the word:
 - Type one tilde (~) to indicate the best possible hyphenation points, or the only acceptable hyphenation point, in the word.
 - Type two tildes (~~) to indicate your second choice.
 - Type three tildes (~~~) to indicate a poor but acceptable hyphenation point.
 - If you want the word never to be hyphenated, type a tilde before its first letter.

 If you need to include an actual tilde in a word, type a backslash before the tilde (\~).

8. Click Add, and then click Done. The word is added to the currently selected Dictionary List.

Note: Remember that hyphenation points interact with the hyphenation settings in your documents. As a result, the word might not break where you expect it to. Control these settings by choosing Hyphenation in the Paragraph panel menu. (See Hyphenate text.)

Remove or edit words in dictionaries

1. Choose Edit > Spelling > User Dictionary.
2. In the Language menu, choose a language.
3. In the Target menu, choose the dictionary from which you want to remove the word. The Target menu lets you choose an external user dictionary or any open document.
4. In the Dictionary List menu, do one of the following:
 - To modify the list of additions to the selected Target word list, choose Added Words.
 - To modify the list of words that are flagged as misspelled, choose Removed Words.
 - To modify the list of words that are being ignored during the current InDesign session, choose Ignored Words. This list includes all the words for which you've chosen Ignore All.
5. In the word list, edit the word, or select the word and click Remove.
6. Click Done.

Export a word list

You can export word lists to a text file (.txt) and then import that list of words into a user dictionary in InDesign. The words in the text file must be separated by a space, tab, or paragraph return. You can export added words and removed words, but you cannot export ignored words, which are used only in the current session.

1. Choose Edit > Spelling > User Dictionary.
2. Choose the language from the Language menu and the dictionary from the Target menu that contains the list of words you want to export.
3. Click Export, specify the file name and location, and then click Save.

The list of words is saved in a text file. You can edit this list of words in any text editor, and then import the word list. You can also send the word list to others, who can import it into their user dictionaries.

Import a word list

1. Choose Edit > Spelling > User Dictionary.
2. Choose the language from the Language menu and the dictionary from the Target menu.
3. Click Import, locate the text file containing your list of spelling exceptions, and then click Open.

Change dictionary preferences

Use Dictionary preferences to specify how InDesign handles hyphenation and spelling dictionaries. Most languages in InDesign use Proximity dictionaries to verify spelling and to hyphenate words. If you have installed hyphenation or spelling components from a different company, you can select a different vendor for each installed language.

Note: *The Dictionary Preferences dialog box does not enable you to specify the language dictionary used for spell checking or hyphenating text. This dialog box is used to specify which hyphenation and spelling plug-ins InDesign uses for the language specified in the Language field. If you*

use only the default hyphenation and spelling plug-in, you don't need to change any settings in the Dictionary Preferences dialog box. If you install a different spelling or hyphenation plug-in provided by a third-party developer, it appears as an option in the Hyphenation Vendor and Spelling Vendor menus in this dialog box. This would let you select one vendor's hyphenation or spelling engine for some languages and another vendor's hyphenation or spelling engine for other languages.

1. Choose Edit > Preferences > Dictionary (Windows) or InDesign > Preferences > Dictionary (Mac OS).
2. For Language, specify the language for which you want to edit settings or change the hyphenation or spelling vendor.
3. Create, add, or remove user dictionaries. (See [Create or add user dictionaries.](#))
4. If you have installed a hyphenation component from a company other than Adobe, select it in the Hyphenation menu.
5. If you have installed a spelling dictionary component from a company other than Adobe, select it in the Spelling menu.
6. In the Compose Using menu in the Hyphenation Exceptions menu, do one of the following:
 - To compose text using the hyphenation exceptions list stored in the external user dictionary, choose User Dictionary.
 - To compose text using the hyphenation exceptions list stored inside the document, choose Document.
 - To compose text using both lists, choose User Dictionary And Document. This is the default setting.
7. To add the exceptions list stored in the external user dictionary to the exceptions list stored within the document, select Merge User Dictionary Into Document.

Note: If you work with many different partners or clients, you might want to deselect the Merge User Dictionary Into Document option. For example, if you're a service provider, you probably don't want your user dictionary merged with every customer's file.
8. To recompose all stories when certain settings are changed, select Recompose All Stories When Modified. Selecting this option recomposes stories when you change the Compose Using settings (see step 6) or when you use the Dictionary command to add or remove words. Recomposing all stories can take some time, depending on the amount of text in the document.
9. Click OK.

Using dictionaries in a workgroup

Make sure that each station in your workgroup has the same customized user dictionaries installed and added, so that a document uses the same spelling and hyphenation rules regardless of who is working on it. You can either make sure that everyone adds the same dictionaries to their computer, or you can share a user dictionary over the network server.

A lock icon  indicates that a dictionary is locked and can be used, but not edited. When a user dictionary is stored on a server, the first user to load the dictionary locks the file; all subsequent users see that the dictionary is locked. Files can also be locked through the operating system, when the file is made read-only. If you share a user dictionary over the network server, you may want to lock the file so that it's read-only for all users, allowing only the administrator to add words.

Make sure that everyone in the workgroup uses the customized user dictionary installed on the common network workstation, and not the dictionary stored with a document. However, before you take a document to a service provider, you might want to merge the user dictionary into the document.

If you don't share a customized user dictionary on a common network workstation, locate user dictionary files and copy them from one workstation to another. The location of user dictionaries appear in the Dictionary preferences.

 After you update a shared workstation's user dictionary, the changes don't appear in individual workstations until a user restarts InDesign or presses **Ctrl+Alt+R** (Windows) or **Command+Option+R** (Mac OS) to recompose all text.

Adobe also recommends

 Twitter™ and Facebook posts are not covered under the terms of Creative Commons.

[Legal Notices](#) | [Online Privacy Policy](#)

Editing text

Select text

View hidden (nonprinting) characters

Add column, frame, and page breaks

Use the Story Editor

Use conditional text

[To the top](#)

Select text

- Using the Type tool, do one of the following:
 - Drag the I-bar cursor over a character, word, or an entire text block to select it.
 - Double-click a word to select it. Spaces next to the word are not selected.
 - Triple-click anywhere in a line to select a line. If the Triple Click To Select A Line preferences option is deselected, triple-clicking selects the entire paragraph.
 - If the Triple Click To Select A Line option is selected, quadruple-click anywhere in a paragraph to select the entire paragraph.
 - Quintuple-click to select the entire story, or click anywhere in a story and choose Edit > Select All.

Note: If you select text that contains a note anchor, using any of the above procedures, the note and its contents are also selected.

If you cannot select text in a frame, the text frame could be on a locked layer or on a master page. Try unlocking the layer or going to the master page. The text frame may also be beneath another text frame or transparent object. See [Select text in a frame that is covered](#).

Change what triple-clicking does

1. Choose Edit > Preferences > Type (Windows) or InDesign > Preferences > Type (Mac OS).
2. Select Triple Click To Select A Line to enable triple-clicking to select a line (this is the default). Deselect this option if you want triple-clicking to select a paragraph.

Select text in a frame that is covered

1. Using the Selection tool , hold down Ctrl (Windows) or Command (Mac OS) and click to select the text frame.
2. Select the Type tool, and then click inside the text frame or select text.

[To the top](#)

View hidden (nonprinting) characters

1. Choose Type > Show Hidden Characters.
2. If hidden characters still do not appear, turn off preview mode. Choose View > Screen Mode > Normal and choose View > Overprint Preview

to deselect it.

Nonprinting characters such as those for spaces, tabs, ends of paragraphs, index markers, and ends of stories appear. These special characters are visible only in a document window and a story editor window; they don't print or output to formats such as PDF and XML. The hidden characters appear in the same color as the layer color.

Growth in production of custom hand-made guitars by year:

1996	1997	1998
12	36	89

Growth in production of custom hand-made guitars by year:¶



























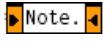

» 1996	» 1997	» 1998 ¶
» 12	» 36	» 89#

Nonprinting characters hidden (top) and visible (bottom)

Anne Marie Concepcion provides a comprehensive list of special characters at [Free Guide to InDesign Special Characters](#).

List of hidden characters

Hidden character	What it represents
¶	End of Paragraph
↵	Soft return (line break)
·	Space
#	End of Story
-	Discretionary Hyphen
—	Nonbreaking Hyphen
»	Tab
↵	Right Indent Tab
†	Indent to Here
\	End Nested Style Here
~	Non-Joiner
⋯	Ideographic Space
␣	Em Space
␣	En Space

	Nonbreaking Space
	Nonbreaking Space (Fixed Width)
	Hair Space
	Sixth Space
	Thin Space
	Quarter Space
	Third Space
	Punctuation Space
	Figure Space
	Flush Space
	Column Break
	Frame Break
	Page Break
	Odd Page Break
	Even Page Break
	Forced Line Break
	InCopy Note
	InCopy Note (in Story Editor)
	Position marker (InCopy only)
	Index marker
	Index marker (in Story Editor)
	Hidden conditional text
	Hidden conditional text (in Story Editor)
	Bookmark or hyperlink destination marker (often a text anchor)
	Bookmark or hyperlink destination marker (in Story Editor)
	Hyperlink destination (in Story Editor)
	Cross-referenced paragraph
	Cross-reference hyperlink (in Story Editor)
	Anchored object
	Anchored object (in Story Editor)

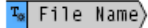
	XML tag
	XML tag (in Story Editor)
	Footnote (in Story Editor)
	Table (in Story Editor)
	Variable (in Story Editor)
	Index marker (in Story Editor)

[To the top](#)

Add column, frame, and page breaks

Control column, frame, and page breaks by inserting special break characters in the text.

1. Using the Type tool, click to place the insertion point where you want the break to occur.
2. Choose Type > Insert Break Character, and then choose a break option from the submenu.

 You can also create breaks by using the Enter key on the numeric keypad. For a column break, press Enter; for a frame break, press Shift+Enter; and for a page break, press Ctrl+Enter (Windows) or Command+Return (Mac OS).

To remove a break character, choose Type > Show Hidden Characters so that you can see nonprinting characters, and then select and delete the break character.

Note: If you create a break by changing paragraph settings (as in the Keep Options dialog box), the break precedes the paragraph that contains the setting. If you create a break using a special character, the break occurs immediately after the special character.

Break options

The following options appear on the Type > Insert Break Character menu:

Column break

Flows text to the next column in the current text frame. If the frame has only one column, the text goes to the next threaded frame.

Frame break

Flows text to the next threaded text frame, regardless of the current text frame's column setup.

Page break

Flows text to the next page with a text frame threaded to the current text frame.

Odd page break

Flows text to the next odd-numbered page with a text frame threaded to the current text frame.

Even page break

Flows text to the next even-numbered page with a text frame threaded to the current text frame.

Paragraph Return

Inserts a paragraph return (the same as pressing Enter or Return).

Forced Line Break –

Forces a line to break where the character is inserted, starting a new line without starting a new paragraph (the same as pressing Shift+Enter or Shift+Return). A forced line break is also called a soft return.

Discretionary Line Break ¶

Indicates where a line of text should break if the line needs to break. A discretionary line break is similar to a discretionary hyphen, only no hyphen is added where the line breaks.

Related break options are available in the Keep Options dialog box and in the Paragraph Style Options dialog box.

[To the top](#)

Use the Story Editor

You can edit text in InDesign either on the layout page or in the story editor window. Writing and editing in a story editor window allows the entire story to appear in the typeface, size, and spacing that you specify in Preferences, without layout or formatting distractions. The Story Editor is also where you can view track changes to text.

Each story appears in a different story editor window. All the text in the story appears in the story editor, including overset text. You can open several story editor windows simultaneously, including multiple instances of the same story. A vertical depth ruler indicates how much text is filling the frame, and a line indicates where text is overset.

When you edit a story, changes are reflected in the layout window. Open stories are listed in the Window menu. You cannot create a new story in a story editor window.

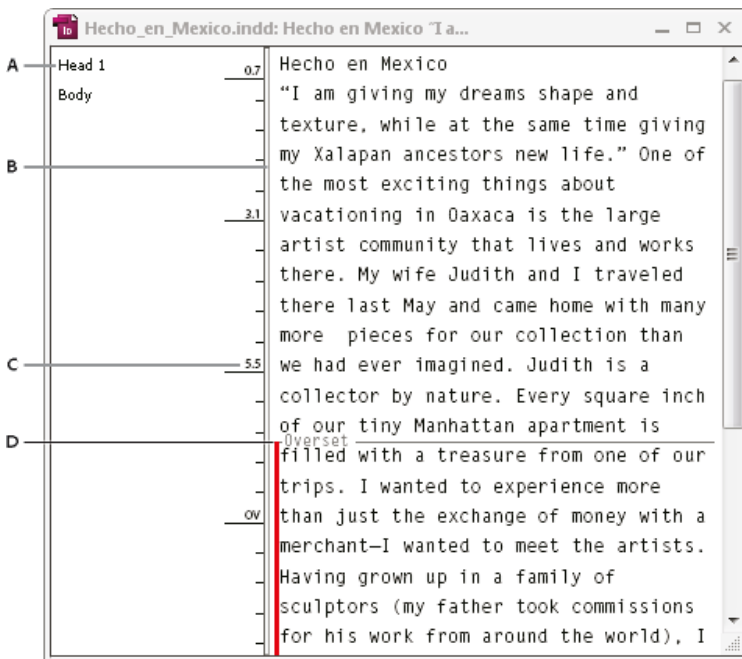

Story Editor window

A. Paragraph styles **B.** Drag divider to adjust column width **C.** Vertical depth ruler **D.** Overset text indicator

You can view and edit tables in Story Editor, where text is displayed in sequential columns and rows for easy editing. Quickly expand or collapse tables, and decide whether to view them by row or column.

The Story Editor also displays text that has been added, removed, or edited if you turn on Track Changes. See Tracking and reviewing changes.

Open the Story Editor

1. Select the text frame, click an insertion point in the text frame, or select multiple frames from different stories.

2. Choose Edit > Edit In Story Editor.

 To open another instance of the same story editor window, make the story editor active, and choose Window > Arrange > New Window.

Return to the layout window

- In Story Editor, do one of the following:
 - Choose Edit > Edit In Layout. When you use this method, the layout view displays the same text selection or insertion-point location as last appeared in the story editor, and the story window remains open but moves behind the layout window.
 - Click in the layout window. The story window remains open but moves behind the layout window.
 - Close the story editor window.
 - Choose the document name from the bottom of the Window menu.







Show or hide Story Editor items

You can show or hide the style name column and the depth ruler, expand or collapse footnotes, and show or hide paragraph break marks to indicate the start of new paragraphs. These settings affect all open story editor windows, as well as all subsequently opened windows.

- With the story editor active, choose View > Story Editor > Show Style Name Column or Hide Style Name Column. You can also adjust the width of the style name column by dragging the vertical bar. Subsequent story editor windows have the same column width.
- With the Story Editor active, choose View > Story Editor > Show Depth Ruler or Hide Depth Ruler.
- With the Story Editor active, choose View > Story Editor > Expand All Footnotes or Collapse AllFootnotes.
- With the Story Editor active, choose View > Story Editor > Show Paragraph Break Marks or Hide Paragraph Break Marks.

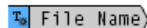
Story Editor preferences

Use Story Editor Display preferences to change the appearance of the Story Editor. Although the Story Editor suppresses all but the most basic text styling attributes, some objects and attributes are represented, including the following:

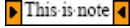
Attribute	Icon
Table	
Inline objects	
XML tags	
Variables	
Hyperlink sources	
Hyperlink anchors	
Cross-reference	
Hidden conditional text	
Note	

Footnotes	
Index markers	
Deleted text	text
Added text	text
Moved text	text

Text Display Options Choose a display font, size, line spacing, text color, and background. You can also specify a different theme, such as selecting Classic System to view yellow text on a black background. These settings affect the display of text in the story editor window, not how they appear in layout view.

Enable Anti-Aliasing Smooth the jagged edges of type, and choose the Type of anti-aliasing: LCD Optimized, Soft, or the Default setting, which uses shades of gray to smooth text. LCD Optimized uses colors, rather than shades of gray, to smooth text, and works best on light-colored backgrounds with black text. Soft uses shades of gray, but produces a lighter, fuzzier appearance than Default.

Cursor Options Change the appearance of the text cursor. For example, select Blink if you want the cursor to blink.

Text from inline frames does not appear in the parent story editor window, but it can appear in its own story editor window.

[To the top](#)

Use conditional text

Conditional text is a way to create different versions of the same document. After you create conditions, you apply them to ranges of text. You can then create different versions of documents by showing and hiding conditions. For example, if you're creating a computer manual, you can create separate conditions for Mac OS and Windows. Before you print the Mac OS version of the user guide, you can show all text to which the "Mac" condition is applied and hide all text to which the "Windows" condition is applied. You can then reverse the condition states for printing the user guide for Windows.

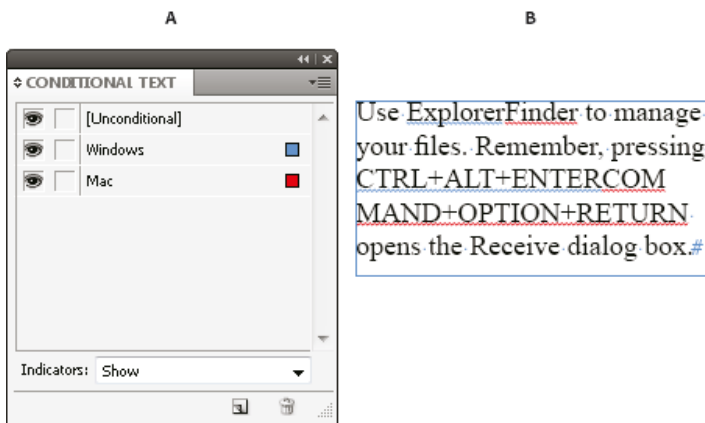

Conditional text shown

A. All conditions shown **B.** Conditional indicators

A

B

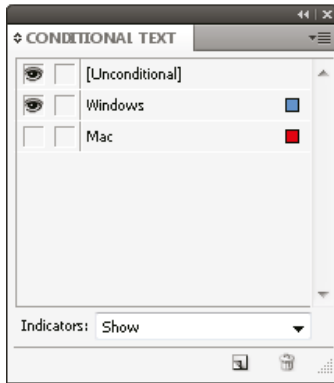

Use Explorer to manage your files. Remember, pressing CTRL+ALT+ENTER opens the Receive dialog box.#

Conditional text hidden

A. "Mac" condition hidden B. Hidden condition symbols

Conditions can be applied only to text. You can make anchored objects conditional, but only by selecting the anchored object marker. You can apply conditions to text within table cells, but you cannot apply conditions to table cells, columns, or rows. You cannot apply conditions to text in locked InCopy stories.

Planning conditional documents

When planning a project with conditional text, examine the nature of the material and look at how several people can take turns working with it if the document is handed off. Plan to treat conditional text consistently to make the document easier to use and maintain. Use the following guidelines.

Number of versions Define how many versions your finished project will contain. For example, if you're creating a manual that describes a program that runs on both Windows and Mac OS platforms, you might want to produce at least two versions: a Windows version and a Mac OS version. If you want to produce these versions with editorial comments sprinkled in the text during the review process, you'll want even more versions: Mac OS with comments, Mac OS without comments, Windows with comments, and Windows without comments.

For documents with many conditions, you can define condition sets that can be applied to the document for quick versioning.

Number of condition tags required Decide how many condition tags you need to produce the desired versions. A version of a document is defined by a unique set of condition tags. For example, a version of a finished Windows manual might be defined by having a Windows condition tag showing, a Mac OS condition tag hidden, and a Comments condition tag hidden. In this example, you would need to decide whether to use one condition tag for Windows comments and another for Mac OS comments, or whether to use a single condition tag for both Windows and Mac OS comments.

Organization of content Evaluate the extent to which the document can be conditional and how you can organize the material to simplify development and maintenance. For example, you might be able to organize a book so that conditional text is limited to a few documents. Or you might choose to keep versions of a particular chapter in separate files rather than in conditional text, and then use a different book file for each version of the book.

In some instances, such as when working with multiple languages, you may want to create separate layers that you can show or hide rather than using conditions, with each layer including text from a different language.

Tagging strategy Determine the smallest unit of conditional text. For example, if a document will be translated to another language, a whole sentence should be the smallest amount of text you make conditional. Because word order often changes during translation, using conditional text for part of a sentence could complicate translation.

Inconsistency in applying conditions to spaces and punctuation can result in extra spacing or misspelled words. Decide whether to make spaces and punctuation conditional. If conditional text begins or ends with punctuation, make the punctuation conditional too. This makes the text easier to read when you're viewing more than one version.

To avoid word spacing problems, such as having an unconditional space followed by a conditional space, set standards for handling spaces following conditional text (either always conditional or always unconditional).

To avoid confusion, decide the order in which conditional text will appear and use this order throughout the document.

Indexes and cross-references When indexing a document, pay attention to whether index markers are placed inside or outside conditional text. Keep in mind that index markers in hidden conditional text are not included in the generated index.

If you create a cross-reference to conditional text, make sure that the source text has the same condition. For example, if you add a cross-reference in a “Windows” paragraph and the text anchor appears in a “Mac” condition, the cross-reference is unresolved when the “Mac” condition is hidden. “HT” appears next to the cross-reference in the Hyperlinks panel.

If you create a cross-reference to a paragraph in which some text is conditional and then change the visibility settings of that condition, update the cross-reference.

Create conditions

Conditions you create are saved in the current document. If no documents are open when you create a condition, that condition appears in all new documents you create.

You can make conditional text easy to identify by specifying condition *indicators*, such as wavy red underlines.

1. Choose Window > Type & Tables > Conditional Text to display the Conditional Text panel.
2. Choose New Condition from the Conditional Text panel menu, and type a name for the condition.
3. In the Indicator group, specify the appearance of the indicator to which the condition is applied.

By default, indicators (such as wavy red lines) are set to appear in the document but not be printed or output. You can choose an option from the Indicators menu in the Conditional Text panel to hide indicators or to print and output them, which can be useful for review purposes.

4. Click OK.

Apply conditions to text

You can apply multiple conditions to the same text. By default, condition indicators identify conditional text. However, if indicators are hidden, you can use the Conditional Text panel to determine which conditions have been applied to the current text. A solid check mark indicates the condition is applied to the current text. A dim check mark indicates that the condition is applied only to part of the selection.

1. Select the text to which you want to apply the condition.
2. In the Conditional Text panel (Windows > Type & Tables > Conditional Text), do any of the following:
 - To apply a condition, click the condition, or click the box next to the condition name.
 - To apply a condition and remove other conditions applied to the text, Alt-click (Windows) or Option-click (Mac OS) a condition.
 - To remove a condition, click the box next to the condition name to remove the check mark. Or, click [Unconditional] to remove all conditions from the selected text.

Note: You cannot apply keyboard shortcuts to specific conditions. However, you can apply conditions using Quick Apply.

Show or hide conditions

When you hide a condition, all text to which that condition is applied is hidden. Hiding conditions often causes the page numbering to change in a document or book. You can use the Smart Text Reflow feature to add and remove pages automatically as you hide and show conditions.

Hidden conditional text is generally ignored in the document. For example, hidden text is not printed or exported, index markers in hidden conditional text are not included in a generated index, and hidden conditional text is not included when searching or spell-checking text.

When you hide a condition, the hidden text is stored in a hidden condition symbol . If you select text that contains a hidden condition symbol and

try to delete it, InDesign prompts you to confirm that you want to delete the hidden conditional text. You cannot apply other conditions, styles, or formatting to hidden conditional text.

If text has several conditions applied to it and at least one of those conditions is shown while another is hidden, the text is not hidden.

- To show or hide individual conditions, click the visibility box next to a condition name. The eye icon indicates the condition is shown.
- To show or hide all conditions, choose Show All or Hide All from the Conditional Text panel menu.

Use condition sets

A condition set captures the visibility settings for all conditions so that you can quickly apply different document renditions. For example, suppose you have a complex document with platform conditions for Mac OS, Windows XP, Vista, UNIX, language conditions for English, French, German, and Spanish, and editorial conditions such as Editorial Review and Internal Comments. For reviewing the Vista version in French, you can create a set that shows only the Vista, French, and Editorial Review conditions, and hides all the rest.

While sets aren't necessary to do this, they help you quickly and reliably change different condition visibility settings.

1. Apply conditions to text as necessary.
2. If the Set menu doesn't appear in the Conditional Text panel, choose Show Options from the Conditional Text panel menu.
3. In the Conditional Text panel, make the conditions visible or hidden as needed.
4. Choose Create New Set from the Set menu, specify a name for the set, and click OK.

The new set becomes the active set.

5. Do any of the following:
 - To apply the condition set to a document, choose the condition set name from the Set menu.
 - To override a condition set, select the set to make it active, and change the visibility setting of any condition. A plus sign (+) appears next to the condition set. Choose the condition set again to remove overrides. Choose Redefine "[Condition Set]" to update the condition set with the new visibility settings.
 - To delete a condition set, select the condition set, and then choose Delete "[Condition Set]." Deleting a condition set does not delete the set's conditions, nor does it remove the conditions from wherever they are applied.

Manage conditions

- Do any of the following:

Delete a condition Select a condition and click the Delete Condition icon at the bottom of the Conditional Text panel. Specify a condition to replace the deleted condition and click OK. The condition you specify is applied to all text to which the deleted condition was applied.

To delete multiple conditions, Shift-click to select contiguous conditions, or Ctrl-click (Windows) or Command-click (Mac OS) to select non-contiguous conditions, and then click the Delete Condition icon.

Remove a condition from text Removing a condition tag from text is different from deleting a tag from a document. When you remove a tag from text, the tag remains in the document so it can be applied again later.

To remove a condition from text, select the text and click the box next to the condition to remove the check mark, or click [Unconditional] to remove all conditions from the selected text.

Load (import) conditions Choose Load Conditions (to load only conditions) or Load Conditions And Sets from the Conditional Text panel menu. Select the InDesign document from which you want to import the conditions, and click Open. Loaded conditions and sets replace any condition or set that has an identical name.

You cannot load conditions from an InCopy file in InDesign, but you can load conditions from an InDesign file in both InDesign and InCopy. Loaded sets ignore the visibility settings of the conditions currently in the Conditional Text panel.

Synchronize conditions in a book To make sure you're using the same conditions in all documents in a book, create the conditions you want in the style source document, select Conditional Text Settings in the Synchronize Options dialog box, and then synchronize the book.

Show or hide condition indicators Choose Show or Hide from the Indicators menu in the Conditional Text panel to show or hide condition indicators. If you're showing one version and want to see which areas are conditional, show the condition indicators. If you find the condition indicators distracting while viewing the layout, hide the condition indicators. Choose Show And Print if you want the condition indicators to be printed and output.

Change a condition name In the Conditional Text panel, click a condition, pause, and then click the condition name to select it. Type a different name.

Edit condition indicators In the Conditional Text panel, double-click a condition, or select a condition and choose Condition Options from the panel menu. Specify indicator settings, and click OK.

Find and change conditional text

Use the Find/Change dialog box to find text to which one or more conditions have been applied and replace it with one or more other conditions.

1. Show any conditional text you want included in the search.

Hidden text is excluded from the search.

2. Choose Edit > Find/Change.
3. If the Find Format and Change Format boxes don't appear at the bottom of the dialog box, click More Options.
4. Click the Find Format box to display the Find Format Settings dialog box. Under Conditions, select [Any Condition] to search for text in which any condition is applied, [Unconditional] to search for text in which no condition is applied, or select the specific condition or conditions you want to search for. Click OK.

This feature finds text that perfectly matches the selected conditions. For example, if you select both Condition 1 and Condition 2, text to which only one of the conditions are applied isn't found, nor is text found to which these two conditions and another is applied.

5. Click the Change Format box to display the Change Format Settings dialog box. Specify the different formatting option, such as a condition or a character style, and then click OK.

If you select the Conditions section in the Change Format Settings dialog box, the [Any Condition] makes no changes to the found conditional text. This option is useful if you want to apply different formatting, such as a character style. Select [Unconditional] to remove all conditions from the found text. If you select a specific condition, specify whether you want it to replace any condition applied to the found text or be added to it.

6. Click Find, and then use the Change, Change/Find, or Change All buttons to replace the condition.

Adobe also recommends



Twitter™ and Facebook posts are not covered under the terms of Creative Commons.

[Legal Notices](#) | [Online Privacy Policy](#)

Captions

[Generate a caption from an image](#)

[Specify caption setup options](#)

[Create captions using variables](#)

[Define caption variables](#)

A *caption* is descriptive text that appears below an image. InDesign provides several methods for creating captions that display the image metadata you specify. InDesign provides a special caption variable that displays the specified metadata of an image. If a text frame containing the variable is next to or grouped with the image, the variable displays the metadata of that image. You can generate a caption from an existing image or while placing it, and you can create a text frame that contains a caption variable.

For video tutorials on generating captions from metadata, see <http://tv.adobe.com/go/4958/>.



Caption generated from image metadata

[To the top](#)

Generate a caption from an image

When you generate a caption from an existing image, you can generate either a *static caption*, which can be modified only manually, or a *live caption*, which is updated if the image or the image metadata changes. For example, if you move a live caption next to a different image, the caption displays metadata from the different image.

When you choose Generate Live Caption, a new variable is generated automatically based on the current caption settings. For example, if the Description metadata type is selected in the Caption Setup dialog box, a variable called “Live Metadata Caption: Description” is created.

1. To determine the content and appearance of the caption you generate, choose Object > Captions > Caption Settings, and specify settings. See [Specify caption setup options](#).
2. Choose Object > Captions > Generate Live Caption or Generate Static Caption.

Note: When you generate a live caption that displays a long string of text, such as a Description, the caption does not break across lines because it is a variable. If a caption is compressed into a single line, consider converting a live caption to a static caption. To convert a live caption to a static caption, select the live caption and choose Object > Captions > Convert To Static Caption.

You can also generate a static caption while placing an image. In the Place dialog box, select Create Static Captions, and then place the caption text frame after placing the image.

[To the top](#)

Specify caption setup options

Use the Captions Settings dialog box to determine the content and formatting of captions you generate. These captions affect only future captions you generate, not existing captions.

1. Choose Object > Captions > Caption Settings.
2. Choose the metadata you want to include, and specify the text that appears before and after the metadata.
3. To include multiple rows of metadata, click the plus sign icon.
4. Specify the following options, and click OK.

Text Before / Text After The text that appears before or after the specified metadata.

Metadata Choose the metadata option, such as Description or City, from the list.

Alignment Specify where to place the caption in relation to the image.

Offset Specify how far apart the caption text is from the edge of the text frame next to the image.

Paragraph Style Specify a paragraph style to apply to the caption text. If you want the caption to include automatic numbering, such as “Figure 1,” “Figure 2,” and so on, include the numbering in the paragraph style. See Create running captions for figures and tables.

Layer Specify to which layer the caption belongs.

Group Caption With Image Indicate whether the image frame and caption text frame are grouped.

[To the top](#)

Create captions using variables

When a text frame containing a caption variable is adjacent to or grouped with an image, the caption variable displays the metadata of that image.



Caption variables

A. Text frame with caption variable not next to image **B.** Text frame moved next to image

1. If necessary, define the caption variable you want to use. See [Define caption variables](#).
2. Create the text frame to be used for the caption.
3. With the insertion point in the text frame, choose Type > Text Variables > Insert Variable, and then choose the caption variable you want to include. Insert as many caption variables as needed.

4. Move the caption text frame next to an image frame, or group the caption text frame with the image frame.

If the caption variable is blank, edit the image metadata, and then use the Links panel to update the image. To edit image metadata, see Edit metadata in image files.

[To the top](#)

Define caption variables

Caption variables are updated automatically when a text frame containing a caption variable is moved next to an image. By default, the Name metadata is used for the variable type when you choose Type > Text Variables > Insert Variable > Image Name. You can edit the Image Name variable, or you can create new variables that specify image metadata.

1. Choose Type > Text Variables > Define.
2. Choose New to create a variable or Edit to edit an existing variable.
3. For Type, select Metadata Caption.
4. Choose an option from the Metadata menu.
5. Specify text that appears before or after the metadata, and then choose OK.

 Twitter™ and Facebook posts are not covered under the terms of Creative Commons.

[Legal Notices](#) | [Online Privacy Policy](#)

Adding text to frames

- [Add text to a document](#)
- [Paste text](#)
- [Drag and drop text](#)
- [Place \(import\) text](#)
- [Import Buzzword documents](#)
- [Link or embed imported text files](#)

[To the top](#)

Add text to a document

Add text to a document by typing or by pasting or placing text from a word-processing application. If your word-processing application supports drag-and-drop, you can also drag text into InDesign frames. For large blocks of text, the Place command is an efficient, versatile way to add text to your document. InDesign supports a variety of word-processing, spreadsheet, and text file formats.

When you place or paste text, you do not need to create a text frame first; InDesign will create one for you automatically.

When you place text, you can select Show Import Options to determine whether the imported text maintains its styles and formatting. Before you paste text, you can select All Information or Text Only under Clipboard Handling Preferences to determine whether the pasted text includes additional information such as swatches and styles.

 *If the text you import into your document includes pink, green, or another color of highlighting, you likely have one or more composition preference options turned on. Open the Composition section of the Preferences dialog box, and notice which options are turned on under Highlight. For example, if the pasted text is formatted with fonts not available, the text is highlighted in pink.*

Type text in a document

1. To place the insertion point inside the text frame, do one of the following:

- Using the Type tool , drag to create a new text frame, or click in an existing text frame.
- Using a selection tool, double-click inside an existing text frame. The Type tool is selected automatically.

2. Begin typing.

If you created a text frame on a master page, hold down Ctrl+Shift (Windows) or Command+Shift (Mac OS) as you click in the frame on your document page. This makes a copy of the master page frame on the document page. You can then use the Type tool to add text to the selected frame.

Type Asian text using inline input

1. Choose Edit > Preferences > Advanced Type (Windows) or InDesign > Preferences > Advanced Type (Mac OS).
2. Select Use Inline Input For Non-Latin Text, and then click OK.

You can use a system input method, if available, for adding 2-byte and 4-byte characters. This method is especially useful for entering Asian characters.

Insert placeholder text

InDesign can add placeholder text that you can easily replace with real text later. Adding placeholder text can give you a more complete sense of your document's design.

1. Use the Selection tool to select one or more text frames, or use the Type tool to click in a text frame.
2. Choose Type > Fill With Placeholder Text.

If you add placeholder text to a frame that's threaded to other frames, the placeholder text is added at the start of the first text frame (if all frames are empty) or at the end of the existing text (if some text is already in the threaded frames), through to the end of the last threaded frame.

To remove or replace placeholder text, double-click in any frame in the thread, choose Edit > Select All, and then delete the text.

 *To change the text that is used as placeholder text, create a text file with the text you wish to use, name it Placeholder.txt, and save it in the application folder.*

[To the top](#)

Paste text

If the insertion point is not inside a text frame when you paste text into InDesign, a new plain text frame will be created. If the insertion point is inside a text frame, the text will be pasted inside that frame. If you have text selected when you paste, the pasted text will overwrite the selected text.

Paste text from another application

1. To preserve formatting and information such as styles and index markers, open the Clipboard Handling section of the Preferences dialog box, and select All Information under Paste. To remove these items and other formatting when pasting, select Text Only.
2. Cut or copy text in another application or in an InDesign document.
3. If you like, select text or click in a text frame. Otherwise, the text will be pasted into its own new frame.
4. Do one of the following:
 - Choose Edit > Paste. If the pasted text doesn't include all the formatting, you may need to change settings in the Import Options dialog box for RTF documents.
 - Choose Edit > Paste Without Formatting. (Paste Without Formatting is dimmed if you paste text from another application when Text Only is selected in Clipboard Handling Preferences.)

 *You can also drag text from another application and drop it into an InDesign document, or you can insert a text file or word-processing file into an InDesign document directly from Windows Explorer or Mac OS Finder. The text will be added to a new frame. Shift-dragging removes the formatting. The option you select in the Clipboard Handling section of the Preferences dialog box determines whether information such as index markers and swatches is preserved.*

Adjust spacing automatically when pasting text

When you paste text, spaces can be automatically added or removed, depending on the context. For example, if you cut a word and then paste it between two words, a space appears before and after the word. If you paste that word at the end of a sentence, before the period, a space is not added.

Note: *This feature is used primarily for working with Roman text. Also, this feature is available only when the Roman text to be pasted is set to a*

Roman language in the Character panel.

1. Choose Edit > Preferences > Type (Windows) or InDesign > Preferences > Type (Mac OS).
2. Select Adjust Spacing Automatically When Cutting And Pasting Words, and then click OK.

[To the top](#)

Drag and drop text

You can use the mouse to drag and drop text in the Story Editor or in the Layout View. You can even drag text from the Story Editor to the layout window (or vice versa), or into some dialog boxes such as Find/Change. Dragging the text from a locked or checked-in story copies the text rather than moves it. You can also copy text or create a new frame when dragging and dropping text.

Jeff Witchel provides a video tutorial about drag and drop at [Using InDesign Drag and Drop Text](#).

1. To enable drag and drop, choose Edit > Preferences > Type (Windows) or InDesign > Preferences > Type (Mac OS), select Enable In Layout View, Enable In Story Editor (InDesign), or Enable In Galley/Story View (InCopy), and then click OK.
2. Select the text that you want to move or copy.
3. Hold the pointer over the selected text until the drag and drop icon  appears, and then drag the text.

As you drag, the selected text remains in place, but a vertical bar indicates where the text will appear when you release the mouse button. The vertical bar appears in any text frame that you drag the mouse over.

4. Do any of the following:

- To drop the text in a new location, position the vertical bar where you would like the text to appear and release the mouse button.
- To drop the text in a new frame, hold down Ctrl (Windows) or Command (Mac OS) after you start dragging, and then release the mouse button before releasing the key.
- To drop the text without formatting, hold down Shift after you start dragging, and then release the mouse button before releasing the key.
- To copy the text, hold down Alt (Windows) or Option (Mac OS) after you start dragging, and then release the mouse button before releasing the key.

 You can also use a combination of these modifier keys. For example, to copy unformatted text to a new frame, hold down Alt+Shift+Ctrl (Windows) or Option+Shift+Command (Mac OS) after you start dragging.

If the text you drop doesn't have the proper spacing, select the Adjust Spacing Automatically option in Type Preferences.

[To the top](#)

Place (import) text

When you place a text or spreadsheet file, you can specify options to determine how the imported text is formatted.

1. (Optional) To create links to the files being placed, click File Handling in the Preferences dialog box and select Create Links When Placing Text And Spreadsheet Files.

Selecting this option creates a link to the placed file. You can use the Links panel to update, relink, or remove links to text files. However, if you format linked text in InDesign, the formatting may not be preserved when you update the link. If this option isn't selected, imported text

and spreadsheet files are embedded (not linked).

2. Do one of the following:

- To create a new frame for the placed text, make sure that no insertion point is present and that no text or frames are selected.
- To add text to a frame, use the Type tool  to select text or place the insertion point.
- To replace the contents of an existing frame, use a selection tool to select the frame. If the frame is threaded, a loaded text cursor appears.

 *If you accidentally replace a text file or graphic using this method, choose **Edit > Undo Replace**, and then click or drag to create a text frame.*

3. Choose **File > Place**.

4. Select **Replace Selected Item** if you want the imported file to replace the contents of a selected frame, to replace selected text, or to be added to the text frame at the insertion point. Deselect this option to flow the imported file into a new frame.

5. Select **Show Import Options**, and then double-click the file you want to import.

6. Set import options, and then click **OK**.

If you haven't already designated an existing frame to receive text, the pointer becomes a loaded text icon, ready to flow text wherever you click or drag.

 *The placed text frame can be converted into either a plain text frame or a frame grid, depending on the settings in the **Story** panel. You can choose **Type > Writing Direction > Horizontal** or **Vertical** to determine the frame's writing direction. When text is placed in a frame grid, the document defaults set in the **Grid** tool apply to the frame grid. Apply grid formatting as necessary.*

If you receive an alert that the requested filter wasn't found, you may be trying to place a file from a different word-processing application or from an earlier version of Microsoft® Word, such as Word 6. Open the file in its original application and save it as RTF, which preserves most formatting.

If the imported Microsoft Excel document displays red dots in cells, adjust cell size or text attributes so that overset content becomes visible. You can also place the file as unformatted tabbed text, and then convert the tabbed text to a table.

About import filters

InDesign imports most character and paragraph formatting attributes from text files but ignores most page-layout information, such as margin and column settings (which you can set in InDesign). Note the following:

- InDesign generally imports all formatting information specified in the word-processing application, except information for word-processing features not available in InDesign.
- InDesign can add imported styles to its list of styles for the document. A disk icon  appears next to imported styles. (See **Convert Word styles to InDesign styles**.)
- The import options appear when you select **Show Import Options** in the **Place** dialog box, or when you import an Excel file. If **Show Import Options** is deselected, InDesign uses the import options last used for a similar document type. The options you set remain in effect until you change them.
- If InDesign cannot find a filter that recognizes a file by either its file type or file extension, an alert message appears. For best results in Windows, use the standard extension (such as .doc, .docx, .txt, .rtf, .xls, or .xlsx) for the type of file you're importing. You may need to open the file in its original application and save it in a different format, such as RTF or text-only.

For more information on import filters, see the **Filters ReadMe PDF** file at www.adobe.com/go/lr_indesignfilters_cs5_en.

Microsoft Word and RTF import options

If you select Show Import Options when placing a Word file or an RTF file, you can choose from these options:

Table Of Contents Text Imports the table of contents as part of the text in the story. These entries are imported as text only.

Index Text Imports the index as part of the text in the story. These entries are imported as text only.

Footnotes Imports Word footnotes. Footnotes and references are preserved, but renumbered based on the document's footnote settings. If the Word footnotes are not imported properly, try saving the Word document in RTF format and importing the RTF file.

Endnotes Imports endnotes as part of the text at the end of the story.

Use Typographer's Quotes Ensures that imported text includes left and right quotation marks (" ") and apostrophes (') instead of straight quotation marks (" ") and apostrophes (').

Remove Styles And Formatting From Text And Tables Removes formatting, such as typeface, type color, and type style, from the imported text, including text in tables. Paragraph styles and inline graphics aren't imported if this option is selected.

Preserve Local Overrides When you choose to remove styles and formatting from text and tables, you can select Preserve Local Overrides to maintain character formatting, such as bold and italics, that is applied to part of a paragraph. Deselect this option to remove all formatting.

Convert Tables To When you choose to remove styles and formatting from text and tables, you can convert tables to either basic, unformatted tables or unformatted, tab-delimited text.

If you want to import unformatted text and formatted tables, import the text without formatting, and then paste the tables from Word into InDesign.

Preserve Styles And Formatting From Text And Tables Preserves the Word document's formatting in the InDesign or InCopy document. You can use the other options in the Formatting section to determine how styles and formatting are preserved.

Manual Page Breaks Determines how page breaks from the Word file are formatted in InDesign or InCopy. Select Preserve Page Breaks to use the same page breaks used in Word, or select Convert To Column Breaks or No Breaks.

Import Inline Graphics Preserves inline graphics from the Word document in InDesign.

Import Unused Styles Imports all styles from the Word document, even if the styles aren't applied to text.

Convert Bullets & Numbers To Text Imports bullets and numbers as actual characters, preserving the look of the paragraph. However, in numbered lists, the numbers are not automatically updated when the list items are changed.

Track Changes Selecting this option causes Track Changes markups from the Word document to appear in the InDesign document. In InDesign, view track changes in Story Editor.

Import Styles Automatically Imports styles from the Word document into the InDesign or InCopy document. If a yellow warning triangle appears next to Style Name Conflicts, then one or more paragraph or character styles from the Word document have the same name as an InDesign style. To determine how these style name conflicts are resolved, select an option from the Paragraph Style Conflicts and Character Style Conflicts menu. Choosing Use InDesign Style Definition causes the imported style text to be formatted based on the InDesign style. Choosing Redefine InDesign Style causes the imported style text to be formatted based on the Word style, and changes existing InDesign text formatted with the Word style. Choosing Auto Rename causes the imported Word styles to be renamed. For example, if InDesign and Word have a Subheading style, the imported Word style is renamed Subheading_wrd_1 when Auto Rename is selected.

Note: *InDesign converts paragraph and character styles but not bulleted and numbered list styles.*

Customize Style Import Lets you use the Style Mapping dialog box to select which InDesign style should be used for each Word style in the

imported document.

Save Preset Stores the current Word Import Options for later reuse. Specify the import options, click Save Preset, type the name of the preset, and click OK. The next time you import a Word style, you can select the preset you created from the Preset menu. Click Set As Default if you want the selected preset to be used as the default for future imports of Word documents.

Text-file import options

If you select Show Import Options when placing a text file, you can choose from these options:

Character Set Specifies the computer language character set, such as ANSI, Unicode UTF8, or Windows CE, that was used to create the text file. The default selection is the character set that corresponds to the default language and platform of InDesign or InCopy.

Specifies the computer language character set, such as ANSI, Unicode UTF8, Shift JIS, or Chinese Big 5, that was used to create the text file. The default selection is the character set that corresponds to the default language and platform of InDesign or InCopy.

Platform Specifies whether the file was created in Windows or Mac OS.

Set Dictionary To Specifies the dictionary to be used by the imported text.

Extra Carriage Returns Specifies how extra paragraph returns are imported. Choose Remove At End Of Every Line or Remove Between Paragraphs.

Replace Replaces the specified number of spaces with a tab.

Use Typographer's Quotes Ensures that imported text includes left and right quotation marks (" ") and apostrophes (') instead of straight quotation marks (" ") and apostrophes (').

Microsoft Excel import options

You can choose from these options when importing an Excel file:

Sheet Specifies the worksheet you want to import.

View Specifies whether to import any stored custom or personal views, or to ignore the views.

Cell Range Specifies the range of cells, using a colon (:) to designate the range (such as A1:G15). If there are named ranges within the worksheet, these names appear in the Cell Range menu.

Import Hidden Cells Not Saved In View Includes any cells formatted as hidden cells in the Excel spreadsheet.

Table Specifies how the spreadsheet information appears in the document.

Formatted Table InDesign tries to preserve the same formatting used in Excel, although the formatting of text within each cell may not be preserved. If the spreadsheet is linked rather than embedded, updating the link will override any formatting applied to the table in InDesign.

Unformatted Table The table is imported without any formatting from the spreadsheet. When this option is selected, you can apply a table style to the imported table. If you format text using paragraph and characters styles, the formatting is preserved even if you update the link to the spreadsheet.

Unformatted Tabbed Text The table is imported as tab-delimited text, which you can then convert to a table in InDesign or InCopy.

Formatted Only Once InDesign preserves the same formatting used in Excel during the initial import. If the spreadsheet is linked rather than embedded, formatting changes made to the spreadsheet are ignored in the linked table when you update the link. This option isn't available in InCopy.

Table Style Applies the table style you specify to the imported document. This option is available only if Unformatted Table is selected.

Cell Alignment Specifies the cell alignment for the imported document.

Include Inline Graphics Preserves inline graphics from the Excel document in InDesign.

Number Of Decimal Places To Include Specifies the number of decimal places of spreadsheet figures.

Use Typographer's Quotes Ensures that imported text includes left and right quotation marks (" ") and apostrophes (') instead of straight quotation marks (" ") and apostrophes (').

Tagged-text import options

You can import (or export) a text file capable of taking advantage of InDesign formatting capabilities by using the *tagged text* format. Tagged-text files are text files containing information describing the formatting you want InDesign to apply. Properly tagged text can describe almost anything that can appear in an InDesign story, including all paragraph-level attributes, character-level attributes, and special characters.

For information on specifying tags, view the Tagged Text PDF at www.adobe.com/go/learn_id_taggedtext_cs5_en (PDF).

The following options are available when you import a tagged-text file and select Show Import Options in the Place dialog box.

Use Typographer's Quotes Ensures that imported text includes left and right quotation marks (" ") and apostrophes (') instead of straight quotation marks (" ") and apostrophes (').

Remove Text Formatting Removes formatting, such as typeface, type color, and type style, from the imported text.

Resolve Text Style Conflicts Using Specifies which character or paragraph style to apply when there is a conflict between the style in the tagged-text file and the style in the InDesign document. Select Publication Definition to use the definition that already exists for that style in the InDesign document. Select Tagged File Definition to use the style as defined in the tagged text.

Show List Of Problem Tags Before Place Displays a list of unrecognized tags. If a list appears, you can choose to cancel or continue the import. If you continue, the file may not look as expected.

Save Word or RTF import options as presets

1. When placing a Word or RTF file, make sure that Show Import Options is selected, and choose Open.
2. In the Import Options dialog box, specify the desired settings.
3. Click Save Preset, type a preset name, and click OK.
4. (Optional) Click Set As Default to use the preset each time you import a file of that file type.

You can then select custom presets from the Preset menu in the Import Options dialog box whenever you open a Word or RTF file.

[To the top](#)

Import Buzzword documents

Buzzword is a web-based text editor that lets users create and store text files on a web server. In InDesign CS5, you can import and export text from Buzzword documents.

When you import a Buzzword document, a URL-based link is created to the Buzzword document on the server. When the Buzzword document is updated outside InDesign, you can use the Links panel to update the imported version in InDesign. However, doing so removes any changes to the Buzzword text you've made in InDesign.

Note: *The Acrobat.com Buzzword application is available only in English, French, and German.*

1. Choose File > Place From Buzzword.
2. If you haven't already signed in to CS Live, click Sign In, specify your e-mail address and password, and then click Sign In. Once you sign in, the Place Buzzword Documents dialog box displays a list of the Buzzword documents you can import.
3. Select one or more documents you want to import, or paste the URL of the Buzzword document into the Paste URL field.
4. Select any of the following options, and then click OK.

Show Import Options If you select this option, the Buzzword Import Options dialog box appears before you place the file.

Replace Selected Item Select this option to replace the object currently selected in the document.

Link To Document Select this option to create a link between the Buzzword document and the placed text. If you establish a link and update the Buzzword document, the Links panel indicates that the file has been modified. If you update the link, the text in InDesign is updated. However, formatting changes you've made to this text in InDesign are lost.

5. If you selected Show Import Options, specify settings in the Buzzword Import Options dialog box. This dialog box includes most of the same options found in the RTF Import Options dialog box. See [Microsoft Word and RTF import options](#). Buzzword currently does not have a styles feature, so none of the style options are valid at this time.
6. With the loaded text cursor, click or drag to create a text frame.

[To the top](#)

Link or embed imported text files

By default, text you place in InDesign is not linked to the original text file. However, if you select the Create Links When Placing Text And Spreadsheet Files option in File Handling preferences before you place a file, the name of the text file appears in the Links panel. You can use the Links panel to update and manage the file. When you update a linked text file, any editing or formatting changes applied within InDesign are lost. Because of this risk, linked text files are not automatically updated when the original file is edited. However, you can easily use the Links panel to update content or to unlink (embed) the file.

1. Do one of the following:
 - To apply this change to a document, open the document.
 - To apply this change to any new document you create, close all documents.
2. Choose Edit > Preferences > File Handling (Windows) or InDesign > Preferences > File Handling (Mac OS).

3. To create links in placed files, select Create Links When Placing Text And Spreadsheet Files. If this option is turned on, use the Links panel to update, relink, or remove links. If this option is turned off, text files are embedded (not linked).

 To unlink (embed) a linked text file, select the file in the Links panel, and then choose Unlink from the Links panel menu.

More Help

 Twitter™ and Facebook posts are not covered under the terms of Creative Commons.

[Legal Notices](#) | [Online Privacy Policy](#)

Creating text and text frames

[Create text frames](#)

[Move and resize text frames](#)

[Using text frames on master pages](#)

[Change text frame properties](#)

[Determine word and character counts](#)

[Working with additional languages](#)







[To the top](#)

Create text frames

Text in InDesign resides inside containers called *text frames*. (A text frame is similar to a text box in QuarkXPress and a text block in Adobe PageMaker.)

There are two types of text frames: frame grids and plain text frames. *Frame grids* are the kind of text frames specific to Asian-language composition in which character embboxes and spacing are displayed as grids. Empty text frames in which no grid is displayed are *plain text frames*.

Like graphics frames, text frames can be moved, resized, and changed. The tool with which you select a text frame determines the kind of changes you can make:

- Use the Type tool  to enter or edit text in a frame.
- Use the Selection tool  for general layout tasks such as positioning and sizing a frame.
- Use the Direct Selection tool  to alter a frame's shape.
- Use the Horizontal Grid tool  or the Vertical Grid tool  to create a frame grid. See [Create frame grids](#).
- Use the Type tool  to create a plain text frame for horizontal text, and the Vertical Type tool  to create a plain text frame for vertical text. Use the same tools to edit existing text in a frame.

Text frames can also be connected to other text frames so that the text in one frame can flow into another frame. Frames that are connected in this way are *threaded*. Text that flows through one or more threaded frames is called a *story*. When you place (import) a word-processing file, it comes into your document as a single story, regardless of the number of frames it may occupy.

Text frames can have multiple columns. Text frames can be based on, yet independent of, page columns. In other words, a two-column text frame can sit on a four-column page. Text frames can also be placed on master pages and still receive text on document pages.

 *If you use the same type of text frame repeatedly, you can create an object style that includes text frame formatting such as stroke and fill colors, text frame options, and text wrap and transparency effects.*

When you place or paste text, you don't need to create a text frame; InDesign automatically adds frames based on the page's column settings.

When text is pasted, a plain text frame is automatically created. You can also create an empty plain text frame manually and input text.

- Do any of the following:
 - Select the Type tool , and then drag to define the width and height of a new text frame. Hold down Shift as you drag to constrain the frame to a square. When you release the mouse button, a text insertion point appears in the frame.

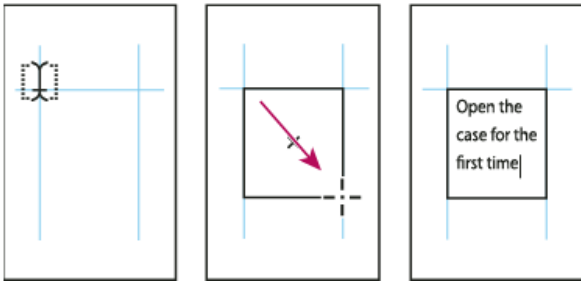

Dragging to create new text frame

- Using the Selection tool, click the in port or out port of another text frame, and then click or drag to create another frame.
- Use the Place command to place a text file.
- Using the Type tool **T**, click inside any empty frame. If the Type Tool Converts Frames To Text Frames option is selected in Type preferences, the empty frame is converted to a text frame.

[To the top](#)

Move and resize text frames

Use the Selection tool to move or resize text frames.

 If you want to move or resize a text frame without switching from the Type tool to a selection tool, hold down **Ctrl** (Windows) or **Command** (Mac OS), and then drag the frame.

Move a text frame

- Using the Selection tool, drag the frame.
- Using the Type tool, hold down **Ctrl** (Windows) or **Command** (Mac OS) and drag the frame. When you release the key, the Type tool is still selected.

Resize a text frame

- Do any of the following:
 - To resize using the Type tool **T**, hold down **Ctrl** (Windows) or **Command** (Mac OS), and drag any frame handle. If you hold down the mouse button for one second before you begin dragging, the text will recompose while you resize the frame.

Note: If you click the text frame instead of dragging it, you'll lose your text selection or insertion point location.
 - To resize using the Selection tool , drag any of the frame handles on the frame's border. Hold down **Ctrl** (Windows) or **Command** (Mac OS) to scale the text within the frame. (See *Scale type*.)
 - To quickly fit the frame to its content, use the Selection tool to select the text frame, and double-click any handle. For example, if you double-click the center bottom handle, the bottom of the frame snaps to the bottom of the text. If you double-click the center right handle, the height is preserved while the width narrows to fill the frame.

Tip: You can also double-click a handle on an overset text frame to expand the height or width to fit all text in the frame. If a text frame includes more overset text than can reasonably fit on the page, the text frame isn't resized.

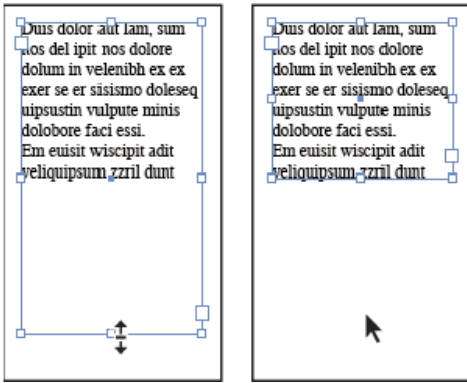

Double-click handle to resize text frame

- To fit the text frame to the content, select the frame using the Selection tool, and choose Object > Fitting > Fit Frame to Content. The bottom of the text frame fits the contents of the text. If a text frame includes more overset text than can reasonably fit on the page, the text frame isn't resized.
- To resize using the Scale tool , drag to resize the frame. (See Scale type.)

[To the top](#)

Using text frames on master pages

When you start a new document, you can select the Master Text Frame option so that an empty text frame is placed on the document's default master page. This frame has the column and margin attributes specified in the New Document dialog box.

Follow these guidelines for using text frames on master pages:

- Set master text frames when you want each page in your document to contain a page-sized text frame into which you can flow or type your text. If your document requires more variation, such as pages with different numbers of frames or frames of different lengths, leave the Master Text Frame option deselected, and use the Type tool to create text frames on masters.
- Whether or not you select the Master Text Frame option, you can add text frames to a master page to act as placeholders. You can thread these empty placeholder frames together to establish a flow.
- Flow text into master text frames using the same procedures you would use with frames created on document pages.
- If you need to type text in a master text frame on a document page, hold down Ctrl+Shift (Windows) or Command+Shift (Mac OS) as you click the text frame on the document page. Then click in the frame using the Type tool and begin typing.
- You can use Smart Text Reflow to add or remove pages automatically as you type and edit text. By default, when you type text at the end of a threaded text frame based on a master page, a new page is added, allowing you to continue typing in the new text frame. You can edit Smart Text Reflow settings.
- If you change the page margins, text frames adjust to the new margins only if the Enable Layout Adjustment option is selected.
- Selecting the Master Text Frame option does not affect whether new pages are added when you autoflow text.

[To the top](#)

Change text frame properties

Use Text Frame Options to change settings such as the number of columns in the frame, the vertical alignment of text within the frame, or the *inset spacing*, which is the distance of the margins between the text and the frame.

Open the case for the first time and take in the sights and smells of your hand-made instrument. See the way the light reflects off the handrubbed satin finish. Breathe in the perfume of the finest exotic tone woods. Then, finally, take it in your hands and begin to play. The experience will leave you swept away, and your life and your music will never be the same again.

For the select few thousand people across the continent playing Antares it's no mystery why our guitars look and sound so different from the multitude of other instruments available to the discerning musician and collector. To this day, each guitar, mandolin, banjo, and dulcimer produced at Antares is afforded the same care and attention to detail as those he created. Open the case for the first time and take in the sights and smells of your hand-made instrument. See the way the light reflects off the handrubbed satin finish. Breathe in the perfume of the finest exotic tone woods. Then, finally, take it in your hands and begin to play. The experience will leave you swept away, and your life and your music will never be the same again.

For the select few thousand people across the continent playing Antares it's no mystery why our guitars look and sound so different from the multitude of other instruments available to the

Open the case for the first time and take in the sights and smells of your hand-made instrument. See the way the light reflects off the handrubbed satin finish. Breathe in the perfume of the finest exotic tone woods. Then, finally, take it in your hands and begin to play. The experience will leave you swept away, and your life and your music will never be the same again.	discerning musician and collector. To this day, each guitar, mandolin, banjo, and dulcimer produced at Antares is afforded the same care and attention to detail as those he created. Open the case for the first time and take in the sights and smells of your hand-made instrument. See the way the light reflects off the handrubbed satin finish. Breathe in the perfume of the finest exotic tone woods. Then, finally, take it in your hands and begin to play. The experience will leave you swept away, and your life and your music will never be the same again.
For the select few thousand people across the continent playing Antares it's no mystery why our guitars look and sound so different from the multitude of other instruments available to the	

Before (left) and after (right) setting inset and creating two columns in a text frame

 If you need to use the same text frame properties for multiple text frames, create an object style that you can apply to your text frames.

1. Using the Selection tool , select a frame, or using the Type tool **T**, click inside the text frame or select text.
2. Choose Object > Text Frame Options, or hold down Alt (Windows) or Option (Mac OS) and then double-click the text frame using a selection tool.
3. Change text frame options, and then click OK.

These text frame options are available when you're defining an object style for text boxes. See Object styles.

Add columns to a text frame

You can create columns within a text frame by using the Text Frame Options dialog box.

 You cannot create columns of unequal width in a text frame. To create columns of unequal width or height, add threaded text frames side-by-side on either a document page or a master page.

1. Using the Selection tool, select a frame, or using the Type tool, click inside the text frame or select text.
2. Choose Object > Text Frame Options.
3. Specify the number of columns, the width of each column, and the spacing between each column (gutter) for the text frame.
4. (Optional) Select Fixed Column Width to maintain column width when you resize the frame. If this option is selected, resizing the frame can change the number of columns, but not their width.

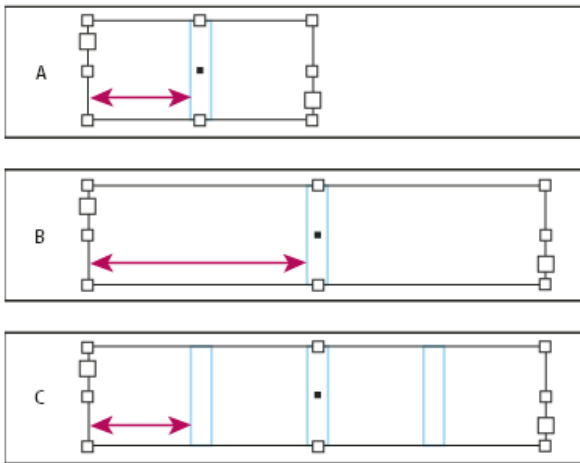

Fixed column width

A. Original 2-column text frame **B.** Resized with Fixed Column Width deselected (still 2 columns) **C.** Resized with Fixed Column Width selected (4 columns)

5. (Optional) Select Balanced Columns to make text even at the bottom of a multi-column text frame.

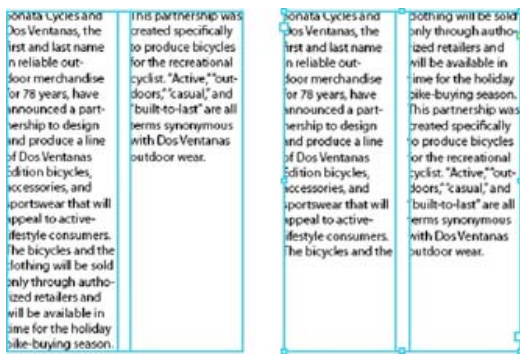

Before and after balancing columns

Change text frame inset spacing (margins)

1. Using the Selection tool, select a frame, or using the Type tool, click inside the text frame or select text.
2. Choose Object > Text Frame Options.
3. In the Inset Spacing section on the General tab, type the offset distances you want for Top, Left, Bottom, and Right. (Click the Make All Settings The Same icon  to use the same spacing on all sides.)

If the frame you've selected has a non-rectangular shape, the Top, Left, Bottom, and Right options are dimmed, and an Inset option is available instead.

First baseline offset options

To change the first baseline options of a selected text frame, choose Object > Text Frame Options, and click the Baseline Options tab. The following options appear in the Offset menu under First Baseline:

Ascent The height of the “d” character in the font falls below the top inset of the text frame.

Cap Height The top of uppercase letters touch the top inset of the text frame.

Leading Use the text’s leading value as the distance between the baseline of the first line of text and the top inset of the frame.

X Height The height of the “x” character in the font falls below the top inset of the frame.

Fixed Specify the distance between the baseline of the first line of text and the top inset of the frame.

Min Select a minimum value for the baseline offset. For example, if Leading is selected and you specify a minimum value of 1p, InDesign uses the leading value only when it’s greater than 1 pica.

 *If you want to snap the top of the text frame to a grid, choose either Leading or Fixed so that you can control the location of the first baseline of text in text frames.*

Set baseline grids for a text frame

In some cases, you might want to use a baseline grid for a frame rather than for the entire document. Use the Text Frame Options dialog box to apply a baseline grid to a text frame. When you set up a baseline grid for a text frame, note the following:

- The document baseline grid doesn’t appear behind or in front of text frames that use their own baseline grids.
- If Grids In Back is selected in Grids Preferences, then frame-based baseline grids take precedence over document-based baseline grids. If Grids In Back is not selected, then document-based baseline grids take precedence over frame-based baseline grids.

1. Choose View > Grids & Guides > Show Baseline Grid to display all baseline grids, including those in a text frame.

2. Select the text frame or place the insertion in a text frame, and then choose Object > Text Frame Options.

If you want the baseline grid to apply to all frames in a thread (even if one or more threaded frames do not include text), place the insertion point in text, choose Edit > Select All, and then apply the baseline grid settings in the Text Frame Options dialog box.

3. Click the Baseline Options tab.

4. Under Baseline Grid, select Use Custom Baseline Grid, and do any of the following:

Start Type a value to offset the grid from the top of the page, the top margin of the page, the top of the frame, or the top inset of the frame, depending on what you choose from the Relative To menu.

Relative To Specify whether you want the baseline grid to begin relative to the top of the page, the top margin of the page, the top of the text frame, or the top of the text frame inset.

Increment Every Type a value for the spacing between grid lines. In most cases, type a value that equals your body text leading, so that lines of text align perfectly to the grid.

Color Select a color for the grid lines, or choose (Layer Color) to use the same color as the layer on which the text frame appears.

 *If you can’t see the baseline grid in a text frame, choose View > Grids & Guides > Show Baseline Grid to make sure that baseline grids aren’t hidden. If the baseline grid still doesn’t appear, check the threshold for viewing baseline grids in the Grids section of the Preferences dialog box. To see the grid, you might need to zoom in on the frame or reduce the threshold level.*

Determine word and character counts

1. Place the insertion point in a text frame to view counts for the entire thread of frames (the story), or select text to view counts only for the selected text.
2. Choose Window > Info to display the Info panel.

The Info panel displays the number of characters, words, lines, and paragraphs in a text frame. The position of the insertion point within the text frame also appears.

Working with additional languages

You can assign languages to different text. Assigning the appropriate language to text is especially useful for spell-checking and hyphenating. (See [Assign a language to text](#).)

If you need to work with Asian text, special versions of InDesign are available for Japanese, Simplified Chinese, Traditional Chinese, and Korean. These versions let you create layout grids and frame grids for composing multibyte characters, and they include a number of features for formatting multibyte text, along with additional fonts.

Similarly, a special version of InDesign is available for formatting Middle Eastern languages, such as Hebrew, Arabic, Farsi, and Urdu, that use right-to-left text formatting. This version is called InDesign ME.

For more information on purchasing InDesign ME or an Asian-language version of InDesign, see the [Adobe website](#).

Adobe also recommends

 Twitter™ and Facebook posts are not covered under the terms of Creative Commons.

[Legal Notices](#) | [Online Privacy Policy](#)

Footnotes

[Create footnotes](#)

[Change footnote numbering and layout](#)

[Delete footnotes](#)

[Work with footnote text](#)

[To the top](#)

Create footnotes

A *footnote* consists of two linked parts: the footnote reference number that appears in text, and the footnote text that appears at the bottom of the column. You can create footnotes or import them from Word or RTF documents. Footnotes are automatically numbered as they are added to a document. Numbering restarts in each story. You can control the numbering style, appearance, and layout of footnotes. You cannot add footnotes to tables or to footnote text.

The width of the footnote text is based on the width of the column containing the footnote reference marker. Footnotes cannot space columns in a text frame.

You cannot create endnotes in InDesign. However, Bob Bringhurst provides a workaround for creating endnotes at [Endnotes in InDesign](#). Endnotes in converted Microsoft Word documents are formatted as text, not footnotes.

1. Place the insertion point where you want the footnote reference number to appear.
2. Choose Type > Insert Footnote.
3. Type the footnote text.

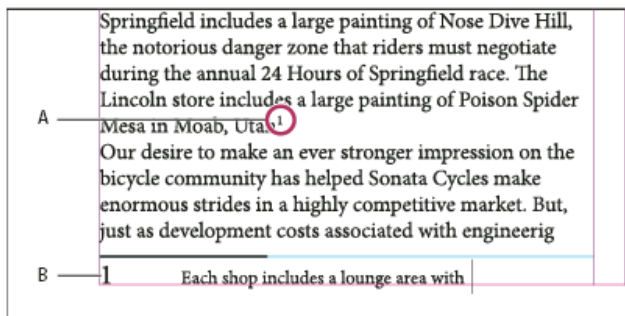

Footnote added to document

A. Reference number **B.** Footnote text

As you type, the footnote area expands while the text frame remains the same size. The footnote area continues to expand upward until it reaches the line with the footnote reference. At that point, the footnote is split to the next text frame column or threaded frame, if possible. If the footnote cannot be split and if more text is added than can fit in the footnote area, the line containing the footnote reference is moved to the next column, or an overset icon appears. In such a case, you should resize the frame or change the text formatting.

 When the insertion point is in a footnote, you can choose Type > Go To Footnote Reference to return to where you were typing. If you use this option frequently, consider creating a keyboard shortcut.

[To the top](#)

Change footnote numbering and layout

Changes you make to footnote numbering and layout affect existing footnotes and all new ones.

1. Choose Type > Document Footnote Options.
2. In the Numbering And Formatting tab, select options that determine the numbering scheme and formatting appearance of the reference number and footnote text.
3. Click the Layout tab, and select options that control the look of the footnote section on the page.
4. Click OK.

Footnote numbering and formatting options

The following options appear in the Numbering And Formatting section of the Footnote Options dialog box:

Numbering Style Choose the numbering style for footnote reference numbers.

Start At Specify the number used for the first footnote in the story. Each story in a document begins with the same Start At number. If you have multiple documents in a book with continued page numbering, you may want to start the footnote numbering in each chapter to continue where the last chapter left off.

The Start At option is especially useful for documents in a book. Footnote numbering is not continued across documents in a book.

Restart Numbering Every If you want numbering to restart within the document, select this option and choose Page, Spread, or Section to determine when footnote numbering is restarted. Some numbering styles, such as asterisks (*), work best when reset every page.

Show Prefix/Suffix In Select this option to show prefixes or suffixes in the footnote reference, the footnote text, or both. Prefixes appear before the number (such as [1]) and suffixes appear after the number (such as 1]). This option is especially useful for placing footnotes within characters, such as [1]. Type a character or characters or select an option for Prefix, Suffix, or both. To select special characters, click the icons next to the Prefix and Suffix controls to display a menu.

 *If you think the footnote reference number is too close to the preceding text, adding one of the space characters as a prefix might improve the appearance. You can also apply a character style to the reference number.*

Position This option determines the appearance of the footnote reference number, which is superscript by default. If you prefer to format the number using a character style (such as a character style that includes OpenType superscript settings), choose Apply Normal, and specify the character style.

Character Style You may want to choose a character style to format the footnote reference number. For example, instead of using superscript, you might want to use a character style at a normal position with an elevated baseline. The menu displays the character styles available in the Character Styles panel.

Paragraph Style You may want to choose a paragraph style that formats the footnote text for all footnotes in the document. The menu displays the paragraph styles available in the Paragraph Styles panel. By default, the [Basic Paragraph] style is used. Note that the [Basic Paragraph] style may not have the same appearance as the default font settings for the document.

Separator The separator determines the white space that appears between the footnote number and the start of the footnote text. To change the separator, first select or delete the existing separator, and then choose a new separator. You can include multiple characters. To insert white space characters, use the appropriate metacharacter, such as ^m for em space.

Footnote layout options

The following options appear in the Layout section of the Footnote Options dialog box:

Minimum Space Before First Footnote This option determines the minimum amount of space between the bottom of the column and the first footnote line. You cannot use a negative value. Any Space Before setting in the footnote paragraph is ignored.

Space Between Footnotes This option determines the distance between the last paragraph of one footnote and the first paragraph of the next footnote in a column. You cannot use a negative value. The Space Before/Space After values in a footnote's paragraph apply only if the footnote includes multiple paragraphs.

First Baseline Offset This option determines the distance between the start of the footnote area (where the footnote divider appears by default) and the first line of footnote text.

For information on the First Baseline options, see Change text frame properties.

Place End Of Story Footnotes At Bottom Of Text Select this option if you want the last column's footnotes to appear just below the text in the last frame of the story. If this option is not selected, any footnote in the last frame of the story appears at the bottom of the column.

Allow Split Footnotes Select this option if you want footnotes to break across a column when the footnote exceeds the amount of space available for it in that column. If splitting is not allowed, the line containing the footnote reference number moves to the next column, or the text becomes overset.

 *If Allow Split Footnotes is turned on, you can still prevent an individual footnote from splitting by placing the insertion point in the footnote text, choosing Keep Options from the Paragraph panel menu, and selecting the Keep Lines Together and All Lines In Paragraph options. If the footnote contains multiple paragraphs, use the Keep With Next X Lines option in the first paragraph of the footnote text. You can choose Type > Insert Break Character> Column Break to control where the footnote is split.*

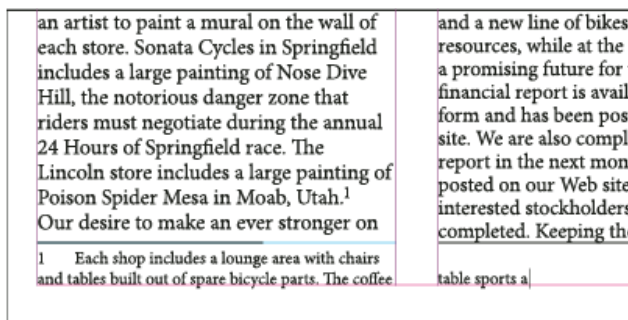

Footnote split across column.

Rule Above Specify the location and appearance of the footnote divider line that appears above the footnote text. A divider line (also called a "separator line") also appears above any footnote text continued in a separate frame. The options you select apply to either the First Footnote In Column or Continued Footnotes, whichever is selected in the menu. These options are similar to those that appear when you specify a paragraph rule. If you want to remove the footnote divider line, deselect Rule On.

[To the top](#)

Delete footnotes

- To delete a footnote, select the footnote reference number that appears in text, and then press Backspace or Delete. If you delete only the footnote text, the footnote reference number and footnote structure remain.

[To the top](#)

Work with footnote text

As you edit footnote text, note the following:

- When the insertion point is in footnote text, choosing Edit > Select All selects all the footnote text for that footnote, but no other footnote or text.

- Use the arrow keys to navigate among footnotes.
- Footnote numbering is not continued across documents in a book. If you don't want numbering to restart in each document with the book, you need to change the Start At value manually in each document after the editing is final.
- In Story Editor, you can click the footnote icon to expand or collapse a footnote. You can expand or collapse all footnotes by choosing View > Story Editor > Expand All Footnotes or Collapse AllFootnotes.
- You can select and apply character and paragraph formatting to footnote text. You can also select and change the appearance of the footnote reference number, but the recommended method is using the Document Footnote Options dialog box.
- When you cut or copy text that includes the footnote reference number, the footnote text is also added to the clipboard. If you copy the text to a different document, the footnotes in that text use the characteristics of the new document's numbering and layout appearance.
- If you accidentally delete the footnote number at the start of the footnote text, you can add it back by placing the insertion point at the beginning of the footnote text, right-clicking (Windows) or Control-clicking (Mac OS), and choosing Insert Special Character > Markers > Footnote Number.
- Text wrap has no effect on footnote text.
- If you clear overrides and character styles on a paragraph that includes a footnote reference marker, the footnote reference numbers lose the attributes you applied in the Document Footnote Options dialog box.

Adobe also recommends

 Twitter™ and Facebook posts are not covered under the terms of Creative Commons.

[Legal Notices](#) | [Online Privacy Policy](#)

Find/Change

- [Find/Change overview](#)
- [Find and change text](#)
- [Search using GREP expressions](#)
- [Metacharacters for searching](#)
- [Find and change objects](#)
- [Find and change glyphs](#)
- [Find and change fonts](#)
- [Find/change items using queries](#)

[To the top](#)

Find/Change overview

The Find/Change dialog box contains tabs that let you specify what you want to find and change.

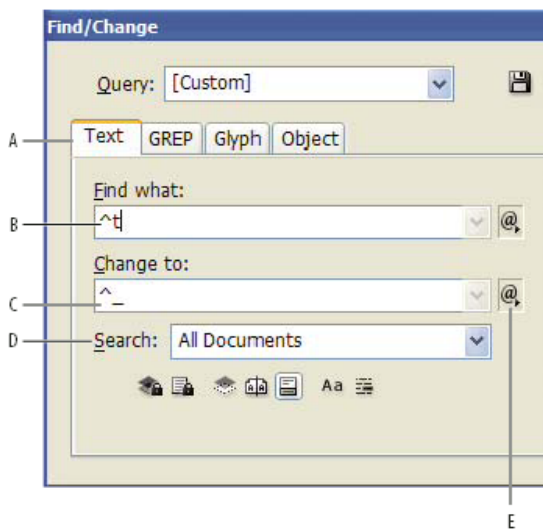

Find/Change dialog box

A. Find/Change tabs **B.** Find a tab character **C.** Replace with an em dash **D.** Search options **E.** Metacharacters menu

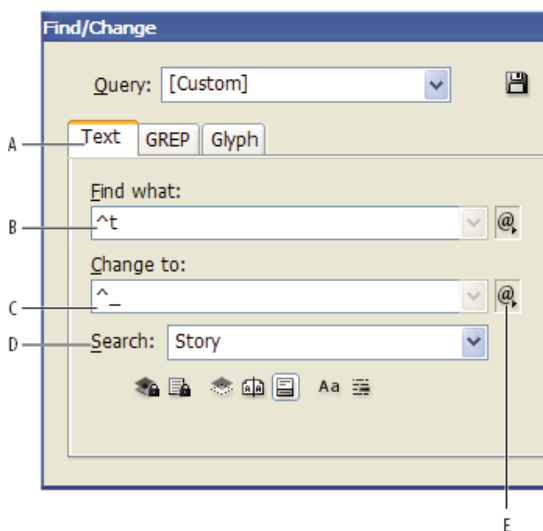

Find/Change dialog box

A. Find/Change tabs **B.** Find a tab character **C.** Replace with an em dash **D.** Search options **E.** Metacharacters menu

Text Search for and change specific occurrences of characters, words, groups of words, or text formatted a certain way. You can also search for and replace special characters such as symbols, markers, and white space characters. Wildcard options help to broaden your search.

GREP Use advanced, pattern-based search techniques to search for and replace text and formatting.

Glyph Search for and replace glyphs using Unicode or GID/CID values, especially useful to search for and replace glyphs in Asian languages.

Object Search for and replace formatting effects and attributes in objects and frames. For example, you can find objects with a 4-pt stroke and replace the stroke with a drop shadow.

[To the top](#)

Find and change text

If you want to list, find, and replace fonts in your document, you might want to use the Find Font command instead of the Find/Change command.

Find and change text

1. To search a range of text or a story, select the text or place the insertion point in the story. To search more than one document, open the documents.
2. Choose Edit > Find/Change, and then click the Text tab.
3. Specify the range of your search from the Search menu, and click icons to include locked layers, master pages, footnotes, and other items in the search.
4. In the Find What box, describe what you want to search for:
 - Type or paste the text you want to find.
 - To search for or replace tabs, spaces, or other special characters, select a representative character (*metacharacter*) from the pop-up menu to the right of the Find What box. You can also choose wildcard options such as Any Digit or Any Character.

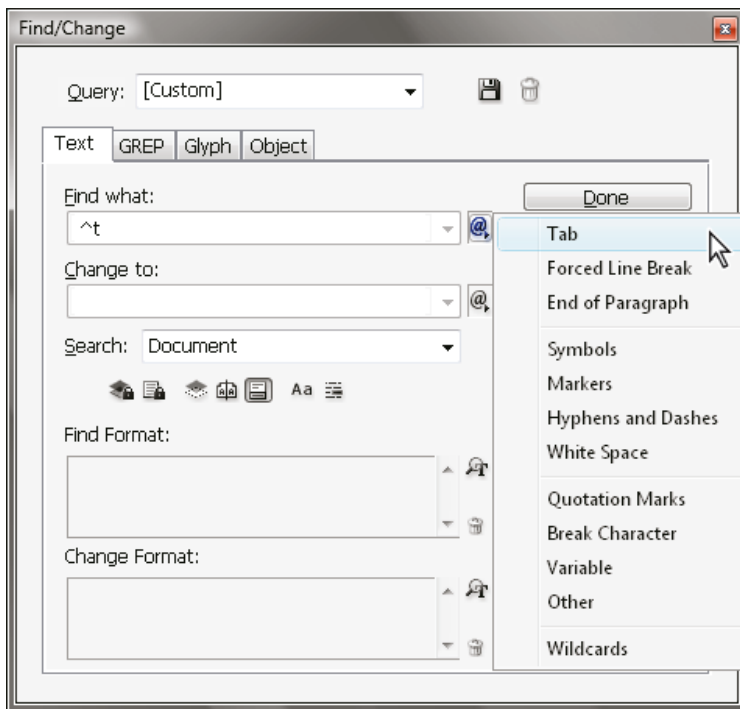

Use metacharacters to search for special characters, such as a tab.

- Use a predefined query to find and replace text. (See [Find/change items using queries.](#))
5. In the Change To box, type or paste the replacement text. You can also select a representative character from the pop-up menu to the right of the Change To box.
 6. Click Find.
 7. To continue searching, click Find Next, Change (to change the current occurrence), Change All (a message indicates the total number of changes), or Change/Find (to change the current occurrence and search for the next one).
 8. Click Done.

If you don't get the search results you expected, make sure that you clear any formatting you may have included in a previous search. You may also need to expand your search. For example, you may be searching only a selection or a story instead of the document. Or, you may be searching for text that appears on an item, such as a locked layer, footnote, or hidden conditional text, that is currently excluded from the search.

If you change your mind about replacing text, choose Edit > Undo Replace Text (or Undo Replace All Text).

To find the next occurrence of a previously searched-for phrase without having to open the Find/Change dialog box, choose Edit > Find Next. In addition, previous search strings are stored in the Find/Change dialog box. You can select a search string from the menu to the right of the option.

Find and change formatted text

1. Choose Edit > Find/Change.
2. If the Find Format and Change Format options don't appear, click More Options.
3. Click the Find Format box, or click the Specify Attributes To Find icon  to the right of the Find Format Settings section.
4. On the left side of the Find Format Settings dialog box, select a type of formatting, specify the format attributes, and then click OK.

Some OpenType formatting options appear in both the OpenType Options and Basic Character Formats (Position menu) sections. For information on OpenType and other formatting attributes, search for the related topic in InDesign Help.

Note: To search for (or replace with) formatting only, leave the Find What or Change To box blank.

5. If you want to apply formatting to the text found, click the Change Format box, or click the Specify Attributes To Change icon  in the Change Format Settings section. Then select a type of formatting, specify the format attributes, and click OK.
6. Use the Find and Change buttons to format the text.

If you specify formatting for your search criteria, info icons appear above the Find What or Change To boxes. These icons indicate that formatting attributes have been set and that the find or change operation will be restricted accordingly.

 To quickly remove all formatting attributes in the Find Format Settings or Change Format Settings sections, click the Clear button.

Common Find/Change techniques

Wildcard searches Specify wildcards, such as Any Digit or Any White Space, to broaden your search. For example, typing “s^?ng” in the Find What box searches for words beginning with an “s” and ending with “ng,” such as “sing,” “sang,” “song,” and “sung.” You can either type wildcard characters or choose an option from the Wildcards submenu in the pop-up menu next to the Find What text field.

Clipboard for metacharacter searches To search for metacharacters such as em dashes or bullet characters, you may want to select the text first and paste it into the Find What box to spare the trouble of entering metacharacters. InDesign automatically converts pasted special characters to their metacharacter equivalent.

Replace with clipboard contents You can replace search items with either formatted or unformatted content copied to the clipboard. You can even replace text with a graphic you copied. Simply copy the item, and then, in the Find/Change dialog box, choose an option from the Other submenu from the pop-up menu to the right of the Change To box.

Find and remove unwanted text To remove unwanted text, define the text you want to remove in the Find What box and leave the Change To box empty (make sure that no formatting is set in this box).

XML tagging You can apply XML tags to text you search for.

Search options for finding and changing text

Search menu Contains options that determine the range of the search.

Documents

Search the entire document or All Documents to search all open documents.

Story

Search all text in the currently selected frame, including text in other threaded text frames and overset text. Select Stories to search stories in all selected frames. This option appears only if a text frame is selected or an insertion point is placed.

To End Of Story

Search from the insertion point. This option appears only if an insertion point is placed.

Selection

Search only selected text. This option appears only if text is selected.

Include Locked Layers

Searches for text on layers that have been locked using the Layer Options dialog box. You cannot replace text on locked layers.

Include Locked Stories

Searches for text in stories that have been checked out as part of an InCopy workflow. You cannot replace text in locked stories.

Include Hidden Layers

Searches for text on layers that have been hidden using the Layer Options dialog box. When text on a hidden layer is found, you can see highlighting where the text appears, but you cannot see the text. You can replace text on hidden layers.

Text in a hidden condition is always omitted from searching.

Include Master Pages

Searches for text on master pages.

Include Footnotes

Searches footnote text.

Case Sensitive

Searches for only the word or words that exactly match the capitalization of the text in the Find What box. For example, a search for *PrePress* won't find *Prepress*, *prepress*, or *PREPRESS*.

Whole Word

Disregards search characters if they are part of another word. For example, if you search for *any* as a whole word, InDesign disregards *many*.

[To the top](#)

Search using GREGP expressions

On the GREGP tab of the Find/Change dialog box, you can construct GREGP expressions to find alphanumeric strings and patterns in long documents or many open documents. You can enter the GREGP metacharacters manually or choose them from the Special Characters For Search list. GREGP searches are case-sensitive by default.

InDesign Secrets provides a list of GREGP resources at [InDesign GREGP](#).

1. Choose Edit > Find/Change, and click the GREGP tab.
2. At the bottom of the dialog box, specify the range of your search from the Search menu, and click icons to include locked layers, master pages, footnotes, and other items in the search.
3. In the Find What box, do any of the following to construct a GREGP expression:
 - Enter the search expression manually. (See [Metacharacters for searching](#).)
 - Click the Special Characters For Search icon to the right of the Find What option and choose options from the Locations, Repeat, Match, Modifiers, and Posix submenus to help construct the search expression.
4. In the Change To box, type or paste the replacement text.
5. Click Find.
6. To continue searching, click Find Next, Change (to change the current occurrence), Change All (a message indicates the total number of changes), or Change/Find (to change the current occurrence and search for the next one).

 You can also use GREGP Styles to apply a character style to text that conforms to a GREGP expression. In fact, the GREGP Styles dialog box is a good way to test your GREGP expression. Add the examples you want to find to a paragraph, and then specify a character style and GREGP expression in the GREGP Styles dialog box. When you turn on Preview, you can edit the expression until it affects all your examples properly.

Tips for constructing GREP searches

Here are some tips for constructing GREP expressions.

- Many searches under the GREP tab are similar to those under the Text tab, but be aware that you need to insert different codes depending on which tab you're using. In general, the Text tab metacharacters begin with a ^ (such as ^t for a tab) and GREP tab metacharacters begin with a \ (such as \t for a tab). However, not all metacharacters follow this rule. For example, a paragraph return is ^p in the Text tab and \r in the GREP tab. For a list of the metacharacters used for the Text and GREP tabs, see [Metacharacters for searching](#).
- To search for a character that has symbolic meaning in GREP, enter a backslash (\) before the character to indicate that the character that follows is literal. For example, a period (.) searches for any character in a GREP search; to search for an actual period, enter "\."
- Save the GREP search as a query if you intend to run it often or share it with someone else. (See [Find/change items using queries](#).)
- Use parentheses to divide your search into subexpressions. For example, if you want to search for "cat" or "cot," you can use the c(a|o)t string. Parentheses are especially useful to identify groupings. For example, searching for "the (cat) and the (dog)" identifies "cat" as Found Text 1 and "dog" as Found Text 2. You can use the Found Text expressions (such as \$1 for Found Text 1) to change only part of the found text.

GREP search examples

Follow these examples to learn how to take advantage of GREP expressions.

Example 1: Finding text within quotation marks

Suppose you want to search for any word enclosed in quotation marks (such as "Spain"), and you want to remove the quotation marks and apply a style to the word (so that it becomes *Spain* instead of "Spain"). The expression (") (\w+) (") includes three groupings, as indicated by parentheses (). The first and third groupings search for any quotation mark, and the second grouping searches for one or more word characters.

You can use the Found Text expressions to refer to these groupings. For example, \$0 refers to all found text, and \$2 refers to only the second grouping. By inserting \$2 in the Change To field and specifying a character style in the Change Format field, you can search for a word within quotation marks, and then replace the word with a character style. Because only \$2 is specified, the \$1 and \$3 groupings are removed. (Specifying \$0 or \$1\$2\$3 in the Change To field would apply the character style to the quotation marks as well.)

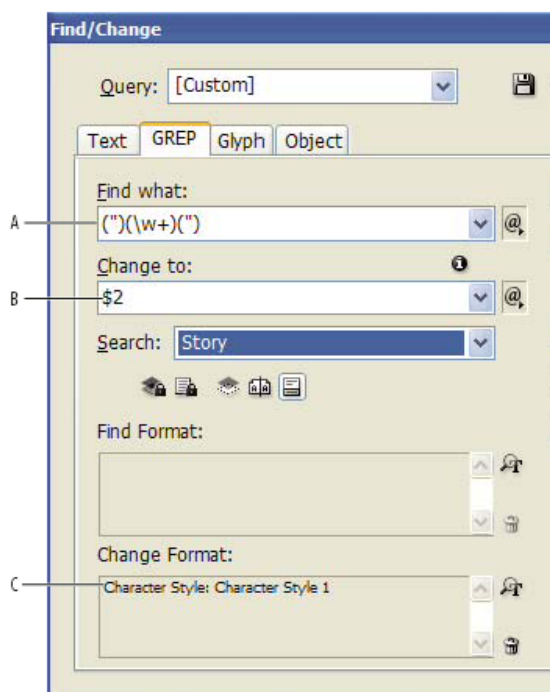

GREP example

A. Finds all word characters enclosed in quotation marks **B.** The character style is applied to the second grouping (the word) while the first and

third groupings (open and close quotes) are removed **C**. Character style specified

This example searches only for single words enclosed in quotation marks. If you want to search for phrases enclosed in parentheses, add wildcard expressions, such as $(\s*.\w*\d*)$, which looks for spaces, characters, word characters, and digits.

Example 2: Phone numbers

InDesign includes a number of search presets that you can choose from the Queries menu. For example, you can choose the Phone Number Conversion query, which looks like this:

$\backslash(?(\d\d\d))?\[-.]?(d\d\d)[-.]?(d\d\d\d)$

Phone numbers in the United States can appear in a variety of formats, such as 206-555-3982, (206) 555-3982, 206.555.3982, and 206 555 3982. This string looks for any of these variations. The first three digits ($\d\d\d$) of the phone number may or may not be enclosed in parentheses, so a question mark appears after the parentheses: $\backslash(? and \)?)$. Note that the backslash \backslash indicates that the actual parenthesis is being searched for and that it's not part of a subexpression. The brackets $[]$ locate any character within them, so in this case, $[-.]$ finds either a hyphen, a period, or a space. The question mark after the brackets indicate that the items within it are optional in the search. Finally, the digits are enclosed in parentheses, which signify groupings that can be referred to in the Change To field.

You can edit the grouping references in the Change To field to suit your needs. For example, you could use these expressions:

206.555.3982 = \$1.\$2.\$3

206-555-3982 = \$1-\$2-\$3

(206) 555-3982 = (\$1) \$2-\$3

206 555 3982 = \$1 \$2 \$3

Additional GREP examples

Experiment with the examples in this table to learn more about GREP searches.

Expression	Search string	Sample text	Matches (in bold)
Class of characters []	[abc] Finds the letter a, b, or c.	Maria cuenta bien.	Mariacuentabien.
Beginning of paragraph ^	^~_+. This searches the beginning of the paragraph (^) for an em dash (~) followed by any character (.) one or more times (+).	“We saw—or at least we think we saw—a purple cow.” —Konrad Yoes	“We saw—or at least we think we saw—a purple cow.” —Konrad Yoes
Negative lookahead (?! <i>pattern</i>)	InDesign (?!CS.*?) The negative lookahead matches the search string only if it is not followed by the specified pattern.	InDesign, InDesign 2.0, InDesign CS, and InDesign CS2	InDesign, InDesign 2.0, InDesign CS, and InDesign CS2
Positive lookahead (?= <i>pattern</i>)	InDesign (?!CS.*?) The positive lookahead matches the search string only if it is followed by the specified pattern. Use similar patterns for negative lookbehinds (?<! <i>pattern</i>) and positive lookbehinds (?<= <i>pattern</i>).	InDesign, InDesign 2.0, InDesign CS, and InDesign CS2	InDesign, InDesign 2.0, InDesign CS, and InDesign CS2

Groupings ()	(quick) (brown) (fox)	The quick brown fox jumps up and down.	The quick brown fox jumps up and down. All found text = quick brown fox; Found Text 1= quick; Found Text 2 = brown; Found Text 3= fox
Non-marking parentheses (?:expression)	(quick) (\$:brown) (fox)	The quick brown fox jumps up and down.	The quick brown fox jumps up and down. All found text = quick brown fox; Found Text 1= quick; Found Text 2 = fox
Case-insensitive on (?i)	(?i)apple You can also use (?i:apple)	Apple apple APPLE	AppleappleAPPLE
Case-insensitive off (?-i)	(?-i)apple	Apple apple APPLE	Apple apple APPLE
Multiline on (?m)	(?m)^\w+ In this example, the expression looks for one or more (+) word characters (w) at the beginning of a line (^). The (?m) expression allows all lines within the found text to be treated as separate lines. (?m)^\w matches the beginning of each paragraph. (?-m)^\w matches only the beginning of the story.	One Two Three Four Five Six Seven Eight	One Two Three Four Five Six Seven Eight
Multiline off (?-m)	(?-m)^\w+	One Two Three Four Five Six Seven Eight	One Two Three Four Five Six Seven Eight
Single-line on (?s)	(?s)c.a The searches for any character (.) between the letters c and a. The (?s) expression matches any character, even if it falls on the next line. (.) matches anything other than a paragraph return. (?s)(.) matches anything, including paragraph returns.	abc abc abc abc	abc abcabc abc
Single-line off	(?-s)c.a	abc abc abc abc	abc abc abc abc
Repeat number of times { }	b{3} matches exactly 3 times b(3,) matches at least 3 times b{3,}? matches at least 3 times (shortest match) b{2,3} matches at least 2	abbc abbbc abbbbc abbbbbc	abbc abbbc abbbbc abbbbbc abbc abbbc abbbbc abbbbbc abbc abbbc abbbbc abbbbbc abbc abbbc abbbbc abbbbbc

times and not more than 3
`b{2,3}?` matches at least 2
times and not more than 3
(shortest match)

`abbbbbc`
`abc abbbc abbbbc`
`abbbbc`

[To the top](#)

Metacharacters for searching

Metacharacters represent a character or symbol in InDesign. Metacharacters in the Text section of the Find/Change dialog box begin with a caret (^); metacharacters in the GREP section begin with a tilde (~) or backslash (\). You can type metacharacters in the Text tab or GREP tab of the Find/Change dialog box.

 *Save time fixing punctuation errors by saving search strings as queries.*

Character:	Text tab metacharacter:	GREP tab metacharacter:
Tab Character	<code>^t</code>	<code>\t</code>
End of Paragraph	<code>^p</code>	<code>\r</code>
Forced Line Break	<code>^n</code>	<code>\n</code>
Any Page Number	<code>^#</code>	<code>~#</code>
Current Page Number	<code>^N</code>	<code>~N</code>
Next Page Number	<code>^X</code>	<code>~X</code>
Previous Page Number	<code>^V</code>	<code>~V</code>
* Any Variable	<code>^v</code>	<code>~v</code>
Section Marker	<code>^x</code>	<code>~x</code>
* Anchored Object Marker	<code>^a</code>	<code>~a</code>
* Footnote Reference Marker	<code>^F</code>	<code>~F</code>
* Index Marker	<code>^I</code>	<code>~I</code>
Bullet Character	<code>^8</code>	<code>~8</code>
Japanese Bullet	<code>^5</code>	<code>~5</code>
Caret Character	<code>^^</code>	<code>\^</code>
Backslash Character	<code>\</code>	<code>\\</code>
Copyright Symbol	<code>^2</code>	<code>~2</code>
Ellipsis	<code>^e</code>	<code>~e</code>
Tilde	<code>~</code>	<code>\~</code>
Paragraph Symbol	<code>^7</code>	<code>~7</code>
Registered Trademark Symbol	<code>^r</code>	<code>~r</code>
Section Symbol	<code>^6</code>	<code>~6</code>

Trademark Symbol	^d	~d
Open Parenthesis Character	(\(
Close Parenthesis Character)	\)
Open Brace Character	{	\{
Close Brace Character	}	\}
Open Bracket Character	[\[
Close Bracket Character]	\]
Em Dash	^_	~_
En Dash	^=	~=
Discretionary Hyphen	^-	~-
Nonbreaking Hyphen	^~	~~
Ideographic Space	^(~(
Em Space	^m	~m
En Space	^>	~>
Third Space	^3	~3
Quarter Space	^4	~4
Sixth Space	^%	~%
Flush Space	^f	~f
Hair Space	^	~
Nonbreaking Space	^s	~s
Nonbreaking Space (fixed width)	^S	~S
Thin Space	^<	~<
Figure Space	^/	~/
Punctuation Space	^.	~.
^ Clipboard Contents, Formatted	^c	~c
^ Clipboard Contents, Unformatted	^C	~C
Any Double Quotation Mark	"	"
Any Single Quotation Mark	'	'
Straight Double Quotation Mark	^"	~"
Double Left Quotation Mark	^{	~{
Double Right Quotation Mark	^}	~}
Straight Single Quotation Mark	^'	~'
Single Left Quotation Mark	^[~[

Single Right Quotation Mark	^J	~J
Standard carriage return	^b	~b
Column Break	^M	~M
Frame Break	^R	~R
Page Break	^P	~P
Odd Page Break	^L	~L
Even Page Break	^E	~E
Discretionary Line Break	^k	~k
Right Indent Tab	^y	~y
Indent to Here	^i	~i
End Nested Style Here	^h	~h
Nonjoiner	^j	~j
* Running header (paragraph style) variable	^Y	~Y
* Running header (character style) variable	^Z	~Z
* Custom text variable	^u	~u
* Last page number variable	^T	~T
* Chapter number variable	^H	~H
* Creation date variable	^S	~S
* Modification date variable	^o	~o
* Output date variable	^D	~D
* File name variable	^l (lowercase L)	~l (lowercase L)
* Any Digit	^9	\d
* Any character that is not a digit		\D
* Any Letter	^\$	[\Lu]
* Any Character	^?	. (inserts period in Change To)
* White Space (any space or tab)	^w	\s (Inserts space in Change To)
* Any character that is not a white space		\S
* Any word character		\w
* Any character that is not a word character		\W
* Any uppercase letter		\u
* Any character that is not an		\U

uppercase letter		
* Any lowercase letter		\l
* Any character that is not a lowercase letter		\L
^ All Found Text		\$0
Found Text 1-9		\$1 (specifies the number of the grouping found, such as \$3 for the third grouping; groupings are enclosed in parentheses)
* Kanji	^K	~K
* Beginning of Word		\<
* End of Word		\>
* Word Boundary		\b
* Opposite of Word Boundary		\B
* Beginning of Paragraph		^
* End of Paragraph [location]		\$
* Zero or One Time		?
* Zero or More Times		*
* One or More Times		+
* Zero or One Time (Shortest Match)		??
* Zero or More Times (Shortest Match)		*?
* One or More Times (Shortest Match)		+?
* Marking Subexpression		()
* Non-marking Subexpression		(?:)
* Character Set		[]
* Or		
* Positive Lookbehind		(?<=)
* Negative Lookbehind		(?<!)
* Positive Lookahead		(?=)
* Negative Lookahead		(?!)
* Case-insensitive On		(?i)
* Case-insensitive Off		(?-i)
* Multiline On		(?m)
* Multiline Off		(?-m)
* Single-line On		(?s)

* Single-line Off		(?-s)
* Any alphanumeric character		[[:alnum:]]
* Any alphabetic character		[[:alpha:]]
* Any blank character, either space or tab		[[:blank:]]
* Any control character		[[:control:]]
* Any graphical character		[[:graph:]]
* Any printable character		[[:print:]]
* Any punctuation character		[[:punct:]]
* Any character whose code is greater than 255 (applies only to the wide character traits classes)		[[:unicode:]]
* Any hexadecimal digit character 0-9, a-f, and A-F		[[:xdigit:]]
* Any character of a certain glyph set, such as a, à, á, â, ã, ä, å, Æ, Å, Ä, Æ, Æ and Å		[[=a=]]

* Can be entered in the Find What box only, not the Change To box.

^ Can be entered in the Change To box, not the Find What box.

[To the top](#)

Find and change objects

You can use the Find/Change command to find and replace the attributes and effects applied to objects, graphics frames, and text frames. For example, to give drop shadows a uniform color, transparency, and offset distance, you can use the Find/Change command to search for and replace drop shadows throughout a document.

1. Choose Edit > Find/Change.
2. Click the Object tab.
3. Click the Find Object Format box, or click the Specify Attributes To Find icon .
4. On the left side of the Find Object Format Options dialog box, select a type of formatting, specify the format attributes, and then click OK.

Make sure that the categories you want to search for are in the appropriate state. You can use one of three states for each Effects category: turned on, turned off, or ignored. For example, setting Drop Shadow to On includes drop shadow formatting in the search; setting Drop Shadow to Off searches for objects in which drop shadow formatting is turned off; setting Drop Shadow to Ignore leaves drop shadows out of the search.

5. If you want to apply formatting to the object found, click the Change Object Format box, or click the Specify Attributes To Change icon  in the Change Format Settings section. Then select a type of formatting, specify the format attributes, and click OK.
6. Click the Find and Change buttons to format the objects.

Find and change glyphs

The Glyph section of the Find/Change dialog box is especially useful for replacing glyphs that share the same unicode value with other similar glyphs, such as alternate glyphs.

InDesign Secrets provides a clear example about finding and changing glyphs at [Finding and Changing Glyphs](#).

1. Choose Edit > Find/Change.
2. At the bottom of the dialog box, specify a range from the Search menu, and click icons to determine whether items such as locked layers, master pages, and footnotes are included in the search.
3. Under Find Glyph, select the Font Family and Font Style in which the glyph is located.

The Font Family menu displays only those fonts that are applied to text in the current document. Fonts in unused styles do not appear.





4. Do one of the following to enter the glyph you want to find in the Glyph box:
 - Click the button beside the Glyph box, and then double-click a glyph on the panel. This panel works like the Glyphs panel.
 - Choose Unicode or GID/CID, and enter the code for the glyph.

 *You can use other methods to enter the glyph you want to find in the Glyph box. Select a glyph in the document window and choose Load Selected Glyph In Find from the context menu, or select a glyph in the Glyphs panel and choose Load Glyph In Find from the context menu.*

5. Under Change Glyph, enter the replacement glyph by using the same techniques you use to enter the glyph you're searching for.
6. Click Find.
7. To continue searching, click Find Next, Change (to change the most recently found glyph), Change All (a message indicates the total number of changes), or Change/Find (to change the current occurrence and search for the next one).
8. Click Done.

Find and change fonts

Use the Find Font command to search for and list the fonts used throughout your document. You can then replace any fonts (except those in imported graphics) with any other fonts available on your system. You can even replace a font that's part of a text style. Note the following:

- A font name is listed once for its use in the layout and listed each time in imported graphics. For example, if you use the same font three times in the layout and three times in imported graphics, it will be listed in the Find Font dialog box four times—once for all layout instances, and three more times for each imported graphic. If fonts are not completely embedded in graphics, the font name may not be listed in the Find Font dialog box.
- Find Font is not available in a Story Editor window.
- The Find Font dialog box displays icons to indicate the kinds of fonts or font conditions, such as Type 1 fonts , imported images , TrueType fonts , OpenType fonts , and missing fonts .
- You can find and change composite fonts, but you cannot change component fonts that are part of composite fonts.

- Use the Type > Find Font command to help ensure consistent output by analyzing font usage on pages and in imported graphics. To find and change specific text attributes, characters, or styles, use the Edit > Find/Change command instead.

1. Choose Type > Find Font.
2. Select one or more font names in the Fonts In Document list.
3. Do one of the following:
 - To find the first occurrence in the layout of the font selected in the list, click Find First. The text using that font moves into view. The Find First button is unavailable if the selected font is used in an imported graphic or if you selected multiple fonts in the list.
 - To select an imported graphic that uses a font marked in the list by an imported image icon , click Find Graphic. The graphic also moves into view. The Find Graphic button isn't available if the selected font is used only in the layout or if you selected multiple fonts in the Fonts In Document list.
4. To see details about a selected font, click More Info. To hide the details, click Less Info. The Info area is blank if you selected multiple fonts in the list.

A font may be listed as Unknown if the file of the selected graphic doesn't supply information about it. Fonts in bitmap graphics (such as TIFF images) won't appear in the list at all because they aren't true characters.

5. To replace a font, select the new font you want to use from the Replace With list, and do one of the following:
 - To change just one occurrence of the selected font, click Change. This option is not available if multiple fonts are selected.
 - To change the font in that occurrence, and then find the next instance, click Change/Find. This option is not available if multiple fonts are selected.
 - To change all instances of the font selected in the list, click Change All. If you want any paragraph or character style that includes the font being searched for to be redefined, select Redefine Style When Changing All.

When there are no more occurrences of a font in your file, its name is removed from the Fonts In Document list.

Note: To change fonts in imported graphics, use the program that originally exported the graphic, and then replace the graphic or update the link using the Links panel.

6. If you clicked Change, click Find Next to locate the next instance of the font.
7. Click Done.

You can open the Find Font dialog box while preflighting a document. In the Preflight dialog box, switch to the Fonts tab and click Find Font.

 To view the system folder in which a font appears, select the font in the Find Font dialog box and choose *Reveal In Explorer (Windows)* or *Reveal In Finder (Mac OS)*.

[To the top](#)

Find/change items using queries

You can find and change text, objects, and glyphs by using or constructing a query. A *query* is a defined find-and-change operation. InDesign offers several preset queries for changing punctuation formats and other useful actions, such as changing telephone number formats. By saving a query you constructed, you can run it again and share it with others.

Search using queries

1. Choose Edit > Find/Change.
2. Choose a query from the Query list.

The queries are grouped by type.

3. Specify a range to search on the Search menu.

The search range is not stored with the query.

4. Click Find.
5. To continue searching, click Find Next, Change (to change the most recently found text or punctuation mark), Change All (a message indicates the total number of changes), or Change/Find (to change text or punctuation marks and continue your search).

After you select a search query, you can adjust the settings to fine-tune your search.

Save queries

Save a query in the Find/Change dialog box if you want to run it again or share it with others. The names of queries you save appear in the Query list in the Find/Change dialog box.

1. Choose Edit > Find/Change.
2. Select Text, GREP, or a different tab to undertake the search you want.
3. Below the Search menu, click icons to determine whether items such as locked layers, master pages, and footnotes are included in the search.

These items are included in the saved query. However, the range of the search isn't saved with the query.

4. Define the Find What and Change To fields. (See [Metacharacters for searching](#) and [Search using GREP expressions](#).)
5. Click the Save Query button in the Find/Change dialog box and enter a name for the query.

If you use the name of an existing query, you are asked to replace it. Click Yes if you want to update the existing query.

Delete queries

- Select it on the Query list and click the Delete Query button.

Load queries

Customized queries are stored as XML files. The names of customized queries appear in the Query list in the Find/Change dialog box.

- To load a query that was given to you so that it appears in the Query list, copy the query file to the appropriate location:

Mac OS Users\[username]\Library\Preferences\Adobe InDesign\[Version]\[Language]\Find-Change Queries\[query type]

Windows XP Documents and Settings\[username]\Application Data\Adobe\InDesign\[Version]\[Language]\Find-Change Queries\[query type]

Windows Vista and Windows 7 Users\[username]\AppData\Roaming\Adobe\InDesign\[Version]\[Language]\Find-Change Queries\[query type]

Adobe also recommends



Twitter™ and Facebook posts are not covered under the terms of Creative Commons.

[Legal Notices](#) | [Online Privacy Policy](#)

Bullets and numbering

- [Create bulleted or numbered lists](#)
- [Format a bulleted or numbered list](#)
- [Change bullet characters](#)
- [Change numbered list options](#)
- [Defining lists](#)
- [Create a paragraph style for running lists](#)
- [Create multi-level lists](#)
- [Create running captions for figures and tables](#)
- [Restart or continue numbering for a list](#)
- [Convert list bullets or numbers to text](#)

[To the top](#)

Create bulleted or numbered lists

In bulleted lists, each paragraph begins with a bullet character. In numbered lists, each paragraph begins with an expression that includes a number or letter and a separator such as a period or parenthesis. The numbers in a numbered list are updated automatically when you add or remove paragraphs in the list. You can change the type of bullet or numbering style, the separator, the font attributes and character styles, and the type and amount of indent spacing.

You cannot use the Type tool to select the bullets or numbers in a list. Instead, edit their formatting and indent spacing using the Bullets And Numbering dialog box, the Paragraph panel, or the Bullets And Numbering section of the Paragraph Styles dialog box (if the bullets or numbers are part a style).

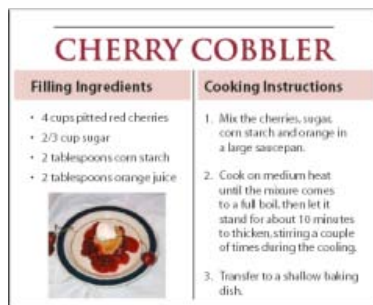



Bulleted list and numbered list

A quick way to create a bulleted or numbered list is to type the list, select it, and then click the Bulleted List or Numbered List button in the Control panel. These buttons let you turn the list on or off and switch between bullets and numbers. You can also make bullets and numbering part of a paragraph style and construct lists by assigning styles to paragraphs.

Note: *Automatically generated bullet and number characters aren't actually inserted in the text. Therefore, they cannot be found during a text search or selected with the Type tool unless you convert them to text. In addition, bullets and numbering don't appear in the story editor window (except in the paragraph style column).*



InDesign Docs provides a series of articles about using bullets and numbering to create [outlines](#), [multi-level lists](#), [figure captions](#), and [numbered steps](#).

1. Select the set of paragraphs that will become the list, or click to place the insertion point where you want the list to begin.
2. Do any of the following:

- Click the Bulleted List button  or the Numbered List button  in the Control panel (in Paragraph mode). Hold down Alt (Windows) or Option (Mac OS) while clicking a button to display the Bullets And Numbering dialog box.
 - Choose Bullets And Numbering from the Paragraph panel or Command panel. For List Type, choose either Bullets or Numbers. Specify the settings you want, and then click OK.
 - Apply a paragraph style that includes bullets or numbering.
3. To continue the list in the next paragraph, move the insertion point to the end of the list and press Enter or Return.
 4. To end the list (or list segment, if the list is to be continued later in the story), click the Bulleted List or Numbered List button in the Control panel again, or choose Bullets And Numbering from the Paragraph panel menu.

[To the top](#)

Format a bulleted or numbered list

1. Using the Type tool , select the bulleted or numbered paragraphs you want to reformat.
2. Do any of the following to open the Bullets And Numbering dialog box:
 - Choose Bullets And Numbering from the Control panel menu (in Paragraph mode) or the Paragraph panel menu.
 - Alt-click (Windows) or Option-click (Mac OS) either the Bulleted List button  or the Numbered List button .
3. In the Bullets And Numbering dialog box, do any of the following:
 - Change the bullet character.
 - Change the numbered list options.
 - Choose a style for the numbers or bullets from the Character Style list.
4. To change the position of the bullet or number, specify any of the following:

Alignment Left-aligns, centers, or right-aligns the bullets or numbers within the horizontal space allotted for numbers. (If this space is narrow, the difference between the three options is negligible.)

Left Indent Specifies how far the lines after the first line are indented.

First Line Indent Controls where the bullet or number is positioned.

Increase the First Line Indent value if you want the punctuation in long lists to be aligned. For example, if you want “9.” and “10.” to be aligned on the period, change the Alignment to Right and gradually increase the first line indent until the numbers align (make sure Preview is turned on).

To create the hanging indent effect, specify a positive Left Indent value (such as 2p0), and then specify an equal negative value (such as -2p0) for First Line Indent.

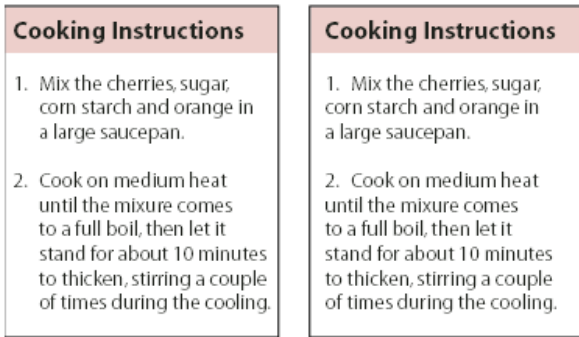

A

B

Position settings

Note: The *Left Indent*, *First Line Indent*, and *Tab Position* settings in the *Bullets And Numbering* dialog box are paragraph attributes. For that reason, changing these settings in the *Paragraph* panel also changes bulleted and numbered list formats.

Tab Position Activates the tab position to create space between the bullet or number and the start of the list item.

By default, bullets and numbers inherit some of their text formatting from the first character in the paragraph to which they're attached. If the first character in one paragraph is different from the first characters in other paragraphs, the numbering or bullet character may appear inconsistent with the other list items. If this is not the formatting you desire, create a character style for numbers or bullets and apply it to your list by using the *Bullets And Numbering* dialog box.

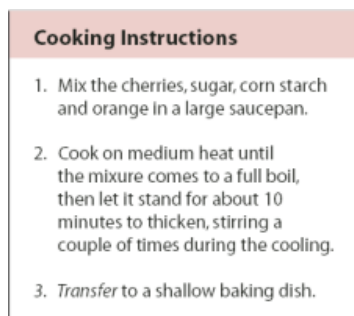

Italicized first word of step 3 causes numbering to be italicized as well, unless you create character style for numbers and apply it to list.

[To the top](#)

Change bullet characters

If you don't want to use one of the existing bullet characters, you can add other bullet characters to the *Bullet Character* grid. A bullet character that is available in one font may not be available in another font. You can choose whether the font is remembered with any bullet character you add.

If you want to use a bullet found in a specific font (such as the pointing hand from *Dingbats*), be sure to set the bullet to remember that font. If you use a basic bullet character, it's probably best not to remember the font, because most fonts have their own version of that bullet character. Depending on whether you select the *Remember Font With Bullet* option, a bullet you add can reference either a *Unicode* value and a specific font family and style, or just a *Unicode* value.

Note: *Bullets that reference only the Unicode value (without a remembered font) appear with a red "u" indicator.*

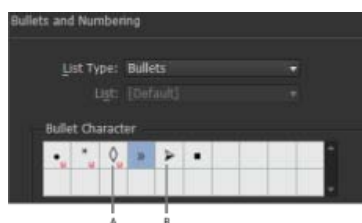

Change the bullet character

1. On the Control panel menu or Paragraph panel menu, select Bullets And Numbering.
2. In the Bullets And Numbering dialog box, select Bullets from the List Type menu.
3. Select a different bullet character, and then click OK.

Add a bullet character

1. In the Bullets And Numbering dialog box, select Bullets from the List Type menu, then click Add.
2. Select the glyph that you want to use as the bullet character. (Different font families and font styles contain different glyphs.)
3. If you want the new bullet to remember the currently chosen font and style, select Remember Font With Bullet.
4. Click Add.

Note: The list of bullet characters is stored in the document, like paragraph and character styles. When you paste or load paragraph styles from another document, any bullet character used in those styles appears in the Bullets And Numbering dialog box, along with the other bullets defined for the current document.

Remove a bullet character

1. In the Bullets And Numbering dialog box, select Bullets from the List Type menu.
2. Select the bullet character you want to remove, and click Delete. (The first preset bullet character cannot be deleted.)

[To the top](#)

Change numbered list options

In a numbered list, the numbers are updated automatically when you add or remove paragraphs in the list. Paragraphs that are part of the same list are numbered sequentially. These paragraphs do not have to be consecutive to one another as long as you define a list for the paragraphs.

You can also create a multi-level list, in which list items are numbered in outline form and are indented by different degrees.

1. Open the Bullets And Numbering dialog box.
2. Under Numbering Style, select the type of numbering you want to use from the Format menu.
3. In the Number box, use the default expression—period (.) and tab space (^t)—or construct a number expression of your own. To enter a number expression, delete the period after the number metacharacter (^#) and do one of the following:

- Type a character (such as a closing parenthesis) or more than one character in place of the period.

Tip: You can also input a full-width separator instead of a half-width period separator, which is especially useful for vertical text.

- Choose an item (such as Em Dash or Ellipses) from the Insert Special Character menu.
 - Type a word or character before the number metacharacter. For example, to number questions in a list, you can type the word **Question**.
4. Choose a character style for the expression. (The style you choose applies to the entire number expression, not just to the number.)
5. For Mode, choose one of the following options:

Continue From Previous Number Numbers lists sequentially.

Start At Starts numbering at a number or other value that you enter in the text box. Enter a number, not a letter, even if your list uses letters or Roman numerals for numbering.

6. Specify any other options, and then click OK.

[To the top](#)

Defining lists

A defined list can be interrupted by other paragraphs and lists, and can span different stories and different documents in a book. For example, use defined lists to create a multi-level outline, or to create a running list of numbered table names throughout your document. You can also define lists for separately numbered or bulleted items that are mixed together. For example, in a list of questions and answers, define one list for numbering the questions and another for numbering the answers.

Defined lists are often used to track paragraphs for numbering purposes. When you create a paragraph style for numbering, you can assign the style to a defined list, and paragraphs are numbered in that style according to where they appear in the defined list. The first paragraph to appear is given number 1 (“Table 1”), for example, and the next paragraph is given number 2 (“Table 2”), even if it appears several pages later. Because both paragraphs belong to the same defined list, they can be numbered consecutively no matter how far apart they are in the document or book.

Define a new list for each type of item you want to number—step-by-step instructions, tables, and figures, for example. By defining multiple lists, you can interrupt one list with another and maintain number sequences in each list.

 *If list items appear in unthreaded frames on the same page, items are numbered in the order in which the text frames are added to the page. To reorder the items, cut and paste the text frames one by one in the order in which you want them to be listed.*

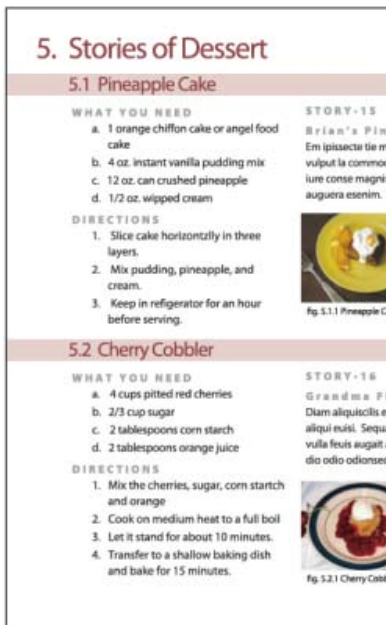

Defined lists let you interrupt one list with another.

Define a list

1. Choose Type > Bulleted And Numbered Lists > Define Lists.
2. Click New in the Define Lists dialog box.
3. Enter a name for the list, choose whether you want to continue numbering across stories, and continue numbering from previous documents in your book.
4. Click OK twice.

After you define a list, you can use it in a paragraph style, such as a style for tables, figures, or ordered lists, as well as apply it by way of the Control panel and Paragraph panel.

Note: Some lists are defined automatically. For example, when you import a numbered list from a Microsoft Word document, InDesign defines a list automatically for your document.

Edit a defined list

1. Choose Type > Bulleted And Numbered Lists > Define Lists.
2. Select a list and click Edit.
3. Enter a new name for the list or change your selection of Continue Numbers options.

Paragraph styles that are assigned to the list are reassigned to the list under its new name.

Delete a defined list

1. Choose Type > Bulleted And Numbered Lists > Define Lists.
2. Select a list.
3. Click Delete, and then select a different list or the [Default] list to replace your list with.

[To the top](#)

Create a paragraph style for running lists

To create a *running list*—a list that is interrupted by other paragraphs or that spans multiple stories or documents—create a paragraph style and apply the style to paragraphs that you want to be part of the list. For example, to create a running list of the tables in your document, create a paragraph style called Tables, make a defined list part of the style, and then apply the Tables paragraph style to all paragraphs you want in your Table list.

InDesign Docs provides a series of articles about using bullets and numbering to create [figure captions](#) and [numbered steps](#).

1. Choose New Paragraph Style from the Paragraph Styles panel menu.
2. Enter a style name.

3. On the left side of the New Paragraph Style dialog box, click Bullets And Numbering.
4. For List Type, select Bullets or Numbering.
5. If you are creating a style for numbered lists, choose a defined list from the List menu, or choose New List and define the list.
6. Specify the bullet or numbering characteristics.
7. Use the Bullet or Number Position section of the New Paragraph Style dialog box to change the indent spacing. For example, to create a hanging indent, type 2p for Left Indent and -2p for First Line Indent.
8. Specify other paragraph style attributes for the style, and then click OK.

[To the top](#)

Create multi-level lists

A *multi-level list* is a list that describes hierarchical relationships between the list paragraphs. These lists are also called *outline lists* because they resemble outlines. The list's numbering scheme (as well as indentations) show rank as well as how items are subordinate to one another. You can tell where each paragraph fits in the list with respect to the paragraphs before and after it. You can include up to nine levels in a multi-level list.

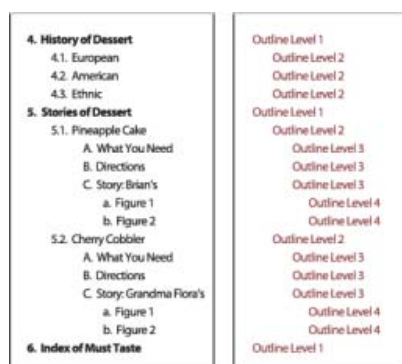

Multi-level list with numbers and letters marking hierarchy levels

To create a multi-level list, define the list and then create a paragraph style for each level you want. For example, a list with four levels requires four paragraph styles (each one assigned the same defined list). As you create each style, you define its numbering format and paragraph formatting.

Gabriel Powell provides a video tutorial about creating outlines and multi-level lists at [Creating an automatic numbered list](#).

Bob Bringhurst provides a series of articles about using bullets and numbering to create [outlines](#), [multi-level lists](#), [figure captions](#), and [numbered steps](#).

1. Choose New Paragraph Style from the Paragraph Styles panel menu.
2. Enter a style name.
3. If you already created a style for your multi-level list, choose the style you will assign to levels above this one from the Based On menu; otherwise, choose No Paragraph Style or Basic Paragraph.
4. On the left side of the New Paragraph Style dialog box, click Bullets And Numbering.
5. Choose Numbers from the List Type menu.

6. Choose a list you defined from the List menu. If you haven't yet defined your list, you can choose New List from the menu and define it now.
7. In the Level box, enter a number that describes which level of the multi-level list you're creating a style for.
8. From the Format menu, choose the type of numbering you want to use.
9. In the Number box, enter metacharacters or select metacharacters from the menus to describe the number formatting you want for list items at this level.
 - To include numbering prefixes from higher levels, enter text or click at the start of the Number box and choose Insert Number Placeholder and then select a Level option (for example, Level 1), or enter ^ and then the list level (for example, enter ^1). In a list with first levels numbered 1, 2, 3, and so on, and second levels numbered a, b, c, and so on, including the first-level prefix in the second level renders second-level numbers as 1a, 1b, 1c; 2a, 2b, 2c; 3a, 3b, 3c.
 - To create a number expression, enter punctuation, enter metacharacters, or select options on the Insert Special Character list.
10. Select Restart Numbers At This Level After to renumber beginning at 1 when a paragraph at this level appears after a paragraph at a higher level; deselect this option to number paragraphs at this level consecutively throughout the list without regard for where the paragraphs appear in the list hierarchy.

To restart numbers after a specific level or range of levels, type the level number or range (such as 2-4) in the Restart Numbers At This Level After field.
11. In the Bullet or Number Position area, choose Indent or Tab Position options to indent list items at this level farther than list items at higher levels. Indenting helps subordinate items in lists stand out.
12. Click OK.

In some cases, such as with numbered steps, you may want to restart numbering within the same story. To avoid restarting the numbered list manually, create a separate style that's identical to the Level 1 style with one exception. For Mode, chose Start At, and then specify 1. Name this style something like "Level 1 Restart."

[To the top](#)

Create running captions for figures and tables

Running captions number figures, tables, and other items consecutively in a document. For example, the first figure caption starts with the words "Figure 1," the second with "Figure 2," and so on. To make sure that figures, tables, or similar items are numbered consecutively, define a list for the item, and then create a paragraph style that includes the list definition. You can also add descriptive words such as "Figure" or "Table" to the numbering scheme of the paragraph style.

Bob Bringhurst provides an article about creating figure captions at [Numbered Lists Part III - Figure Captions](#).

 *List items are numbered in the order in which they are added to the page. To reorder the items, cut and paste the items one by one in the order in which you want them to be listed.*

1. Create a new paragraph style and, in the Bullets And Numbering section of the Paragraph Style Options dialog box, choose Numbers from the List Type menu.
2. Choose a defined list from the List menu (or choose New List to define a list).
3. Under Numbering Style, select the type of numbering you want to use from the Format menu.

For example, select the A, B, C, D... option to create a list for "Figure A," "Figure B," and so on.

4. In the Number box, enter a descriptive word and any spacing or punctuation (as needed) along with the numbering metacharacters.

For example, to create a “Figure A” effect, enter the word “Figure” and a space before the numbering metacharacters (such as **Figure** ^#. ^t). This adds the word “Figure” followed by a sequential number (^#), a period, and a tab (^t).

Note: To include chapter numbers in running captions, choose *Insert Number Placeholder > Chapter Number* from the Number list, or enter ^H where you want the chapter number to appear in the number scheme.

5. Finish creating the style and click OK.

After you create the style, apply it to text figure captions or table titles.

 You can use the *Table Of Contents* feature to generate a list of tables or figures.

[To the top](#)

Restart or continue numbering for a list

InDesign offers commands for restarting a list and continuing a list:

Restarting a numbered list Place the insertion point in the paragraph and choose *Restart Numbering* from the context menu or choose *Type > Bulleted And Numbered Lists > Restart Numbering*. In normal lists, this command assigns the number 1 (or letter A) to a paragraph and makes it the first paragraph in a list. In multi-level lists, this command assigns the first lower-level number to a nested paragraph.

Continuing a numbered list Choose *Continue Numbering* from the context menu or choose *Type > Bulleted And Numbered Lists > Continue Numbering*. This command resumes numbering a list that was interrupted by commentary, graphics, or nested list items. InDesign also offers commands for numbering lists that begin in one story or book and cross into the next story or book.

Number a list from the previous or current story

Whether a list resumes numbering from the previous story or starts numbering anew in the current story depends on how the list is defined.

1. Choose *Type > Bulleted And Numbered Lists > Define Lists*.
2. Select a list and click the *Edit* button.

Don't choose the *Default* list because it can't run across stories.

3. Select *Continue Numbers Across Stories* to resume numbering the list from the previous story, or deselect this option to start the list in the current story at 1 (or A).
4. Click *OK* twice.

Number a list from the previous or current document in a book

Whether a list resumes numbering from the previous document in a book or starts numbering anew in the current document depends on how the list is defined.

1. Choose *Type > Bulleted And Numbered Lists > Define Lists*.

2. Select a list and click the Edit button.
3. Select Continue Numbers From Previous Document In Book to resume numbering the list from the previous document (you must choose Continue Numbers Across Stories to activate this option), or deselect this option to start the list in the current document at 1 (or A).
4. Click OK twice.

 *To make sure that numbering is updated properly in a book, synchronize the documents in the book and choose Update Numbering > Update All Numbers from the books panel menu.*

[To the top](#)

Convert list bullets or numbers to text

1. Select the paragraphs containing the bulleted or numbered list.
2. Do one of the following:
 - From the Paragraph panel menu, choose Convert Numbering To Text or Convert Bullets To Text.
 - Right-click (Windows) or Command-click (Mac OS) the selection, and then choose Convert Numbering To Text or Convert Bullets To Text.

Note: *To remove the list numbers or bullets, click the Numbered List button or Bulleted List button to unapply list formatting to the selected text.*

Adobe also recommends

 Twitter™ and Facebook posts are not covered under the terms of Creative Commons.

[Legal Notices](#) | [Online Privacy Policy](#)

Tracking and reviewing changes

- Track changes
- Accept and reject changes
- Set Track Changes preferences
- Change the user name and color

[To the top](#)

Track changes

A valuable feature is the ability to track changes made to a story by each contributor in the writing and editing process. Whenever anyone adds, deletes, or moves text within an existing story, the change is marked in the Story Editor in InDesign or the Galley and Story views in InCopy. You can then accept or reject the changes.

Use the Track Changes panel in InDesign or the Track Changes toolbar in InCopy to turn Track Changes on or off and to show, hide, accept, or reject changes made by contributors.

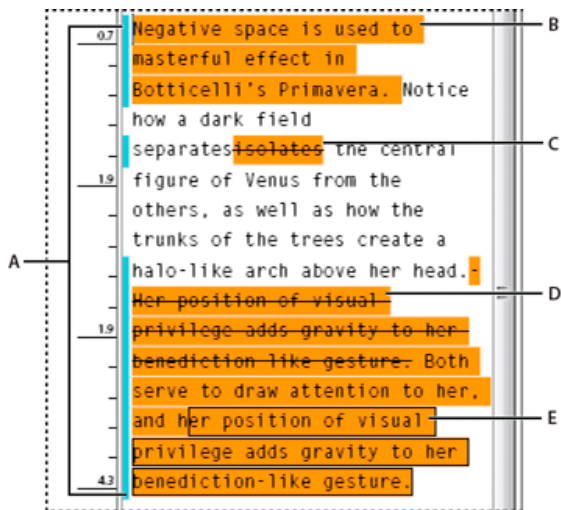

Change tracking shown in Story Editor (InDesign)

A. Change bars B. Added text C. Deleted text D. Moved text (from) E. Moved text (to)

Turn on change tracking

1. Choose Window > Editorial > Track Changes to open the Track Changes panel (InDesign), or choose Window > Track Changes to open the Track Changes toolbar (InCopy).
2. With the insertion point in text, do any of the following:
 - To enable change-tracking in only the current story, click the Enable Track Changes In Current Story icon .
 - (InDesign) To enable tracking in all stories, choose Enable Track Changes In All Stories from the Track Changes panel menu.
 - (InCopy) To enable tracking in all open stories in a multistory document, choose Changes > Enable Tracking In All Stories.

3. Add, delete, or move text within the story as needed.

How change tracking is displayed

When Track Changes is turned on, each change is marked by default as follows in Story Editor (InDesign) or in Galley and Story views (InCopy):

 *The Track Changes section of the Preferences dialog box lets you choose a color to identify your changes. It also lets you select which changes (adding, deleting, or moving text) you want tracked and the appearance of tracking.*

Added text Highlighted.

Deleted text Highlighted and marked with a strikethrough.

Moved (cut-and-pasted) text Highlighted and marked with a strikethrough in its original location; highlighted and boxed in the new location.

Note: *If you cut text from one document and paste it into another, it is displayed as deleted text in the document of its original location and as added text in its new location.*

Copied text Highlighted in the new location. The original text is unchanged.

Change bars A change bar is a vertical line that appears to the left of a line of text that has been changed. You can choose whether to show or hide change bars as you work. You can also specify what color to use for displaying the change bars.

Show or hide changes

When changes are hidden, the text appears as it would with the change-tracking feature turned off. That is, added text is visible, deleted text is invisible, and moved or pasted text appears where it has been inserted.

(InDesign) When change-tracking is turned on, editing is tracked regardless of whether you work in Story Editor or in the document layout. You can view changes only in Story Editor, not in the layout.

(InCopy) When change-tracking is turned on, editing is tracked regardless of whether you work in Galley, Story, or Layout view. You can view changes only in the Galley and Story views, not the Layout view.

- In the Track Changes panel (InDesign) or the Track Changes toolbar (InCopy), click the Show/Hide Changes button .

Turn off change tracking

- With the insertion point in text, do any of the following:
 - To disable change-tracking in only the current story, click the Disable Track Changes In Current Story icon .
 - (InDesign) To disable tracking in all stories, choose Disable Track Changes In All Stories from the Track Changes panel menu.
 - (InCopy) To disable tracking in all open stories in a multistory document, choose Changes > Disable Tracking In All Stories.

Note: *If you disable tracking, no further changes are tracked. Previously tracked changes are not affected.*

View change information in the Track Changes panel

1. Choose Window > Track Changes.

2. Click the insertion point in a change. The Track Changes panel displays the date, time, and other change information.

[To the top](#)





Accept and reject changes

When changes have been made to a story, whether by you or by others, the change-tracking feature enables you to review all changes and decide whether to incorporate them into the story. You can accept or reject single changes, only portions of a tracked change, or all changes at once.

When you accept a change, it becomes a normal part of the text flow and is no longer highlighted as a change. When you reject a change, the text reverts to how it was before the change was made.

1. In Story Editor (InDesign) or Galley or Story view (InCopy), position the insertion point at the beginning of the story.
2. In the Track Changes panel (InDesign) or the Track Changes toolbar (InCopy), click the Next Change button .
3. Do any of the following:
 - To accept the highlighted change and incorporate it into the text flow, click the Accept Change button .
 - To reject the change and revert to the original text, click the Reject Change button .

 *To accept or reject the highlighted change and go to the next change, Alt-click (Windows) or Option-click (Mac OS) the Accept Change or Reject Change button.*

- To move back to the previous change or skip over a change and go to the next one, click the Previous Change button  or Next Change button .
- To accept or reject all changes without reviewing, click the Accept All Changes In Story button  or the Reject All Changes In Story button .
- To accept or reject all changes in the story or in the document, or to accept or reject all changes by a certain participant, choose the appropriate option from the Track Changes panel menu (InDesign) or from the Changes menu (InCopy).

Note: *If you change your mind about accepting or rejecting a change, you can undo the change by choosing Edit > Undo or pressing Ctrl+Z (Windows) or Command+Z (Mac OS).*

Choosing an Accept All Changes or Reject All Changes command also applies to hidden conditional text.

[To the top](#)

Set Track Changes preferences

Preference settings let you control many tracking options. You can choose a color to identify your changes and select what changes you want tracked: adding, deleting, or moving text. You can also set the appearance of each type of tracked change, and you can have changes identified with colored change bars in the margins.

1. Choose Edit > Preferences > Track Changes (Windows) or InDesign > Preferences > Track Changes (Mac OS).
2. Select each type of change that you want to track.
3. For each type of change, specify the text color, background color, and marking method.

4. Select Prevent Duplicate User Colors to ensure that all users are assigned different colors.
5. To show change bars, select the Change Bars option. Choose a color from the Change Bar Color menu, and specify whether you want change bars to appear in the left or right margin.
6. Select Include Deleted Text When Spellchecking if you want to spell-check text marked to be deleted.
7. Click OK.

[To the top](#)

Change the user name and color

1. Choose File > User.
2. Specify the user name and color to be used for change-tracking and notes, and then click OK.

Adobe also recommends



Twitter™ and Facebook posts are not covered under the terms of Creative Commons.

[Legal Notices](#) | [Online Privacy Policy](#)

Text variables

[Create and edit text variables](#)

[Insert text variables](#)

[Delete, convert, and import text variables](#)

[To the top](#)

Create and edit text variables

A *text variable* is an item you insert in your document that varies according to the context. For example, the Last Page Number variable displays the page number of the last page of the document. If you add or remove pages, the variable is updated accordingly.

InDesign includes several preset text variables that you can insert in your document. You can edit the format of these variables, or you can create your own. Some variables, such as Running Header and Chapter Number, are especially useful for adding to master pages to ensure consistent formatting and numbering. Other variables, such as Creation Date and File Name, are useful for adding to the slug area for printing.

Note: Adding too much text to a variable may cause overset or compressed text. Variable text does not break across lines.

Create or edit text variables

The options available for creating the variable depend on the type of variable you specify. For example, if you choose the Chapter Number type, you can specify text to appear both before and after the number, and you can specify the numbering style. You can create several different variables based on the same variable type. For example, you can create one variable that displays “Chapter 1” and another that displays “Ch. 1.”

Similarly, if you choose the Running Header type, you can specify which style is used as the basis for the header, and you can select options for deleting end punctuation and changing the case.

1. If you want to create text variables for use in all new documents you create, close all documents. Otherwise, the text variables you create appear only in the current document.
2. Choose Type > Text Variables > Define.
3. Click New, or select an existing variable and click Edit.
4. Type a name for the variable, such as “Full Chapter” or “Running Title.”
5. From the Type menu, choose a variable type, specify the options for that type, and then click OK.

Different options are available depending on the variable type you select.

Text Before / Text After For all variable types (except Custom Text), you can specify text that will be added before or after the variable. For example, you can add the word “of” before the Last Page Number variable and the phrase “total pages” after the variable to create an “of 12 total pages” effect. You can also paste text into the boxes, but special characters such as tabs and auto page numbers are stripped out. To insert special characters, click the triangle to the right of the text box.

Style For all numbered variable types, you can specify the numbering style. If [Current Numbering Style] is selected, the variable uses the same numbering style selected in the document’s Numbering & Section Options dialog box.

Variable types

Chapter Number

A variable created with the Chapter Number type inserts the chapter number. You can insert text before or after the chapter number, and you can specify a numbering style.

If the document's chapter number is set to continue from the previous document in the book, you may need to update the book's numbering in order for the appropriate chapter number to appear.

Creation Date, Modification Date, and Output Date

Creation Date inserts the date or time the document is first saved; Modification Date inserts the date or time the document was last saved to disk; Output Date inserts the date or time the document starts a print job, exports to PDF, or packages the document. You can insert text before and after the date, and you can modify the date format for all date variables.

Date Format You can type date formats directly into the Date Format box, or you can choose format options by clicking the triangle to the right of the box. For example, the date format "MM/dd/yy" displays as 12/22/07. By changing the format to "MMM. d, yyyy" the date will display as Dec. 22, 2007.

Date variables use the language applied to text. For example, the creation date may appear in Spanish text as "01 diciembre 2007" and in German as "01 Dezember 2007."

Abbreviation	Description	Example
M	Month number, no leading zero	8
MM	Month number, leading zero	08
MMM	Abbreviated month name	Aug
MMMM	Full month name	August
d	Day number, no leading zero	5
dd	Day number, leading zero	05
E	Weekday name, abbreviated	Fri
EEEE	Full weekday name	Friday
yy or YY	Year number, last two digits	07
y (Y) or yyyy (YYYY)	Full year number	2007
G or GGGG	Era, abbreviated or expanded	AD or Anno Domini
h	Hour, no leading zero	4
hh	Hour, leading zero	04
H	Hour, no leading zero, 24-hour format	16
HH	Hour, leading zero, 24-hour format	16
m	Minute, no leading zero	7
mm	Minute leading zero	07
s	Second, no leading zero	7

ss	Second, leading zero	07
a	AM or PM, two characters	PM
z or zzzz	Time zone, abbreviated or expanded	PST or Pacific Standard Time

File Name

This variable inserts the name of the current file into the document. It's commonly added to the slug area of the document for printing or used in headers and footers. In addition to Text Before and Text After, you can choose the following options.

Include Entire Folder Path Select to include the full folder path with the file name. The standard path conventions for either Windows or Mac OS are used.

Include File Extension Select to include the file name extension.

The File Name variable is updated whenever you save the file with a new name or to a new location. The path or extension does not appear in the document until it's saved.

Image Name

The Image Name variable is useful for generating automatic captions from metadata. The Image Name variable includes a Metadata Caption variable type. If a text frame containing this variable is adjacent to or grouped with an image, the variable displays the metadata of that image. You can edit the Image Name variable to determine which metadata field is used.

See Define caption variables.

Last Page Number

The Last Page Number type is useful for adding the total number of pages in a document to headers and footers using the common "Page 3 of 12" format. In this case, the number 12 is generated by the Last Page Number, and it's updated whenever pages are added or removed. You can insert text before or after the last page number, and you can specify a numbering style. From the Scope menu, choose an option to determine whether the last page number in the section or document is used.

Note that the Last Page Number variable does not count the pages in the document.

Running Header (Paragraph or Character Style)

The Running Header variables insert the first or last occurrence on the page of the text to which the specified style is applied. If no text on the page is formatted with the specified style, the text from a previous page is used.

See Create variables for running headers and footers.

Custom Text

This variable is commonly used for inserting placeholder text, or a text string that may need to be changed quickly. For example, if you're working on a project that uses a code name for a company, you can create a custom text variable for the code name. When you are able to use the real company name, you can simply change the variable to update all the occurrences.

To insert special characters in a text variable, click the triangle to the right of the text box.

Insert text variables

1. Place the insertion point where you want the variable to appear.
2. Choose Type > Text Variables > Insert Variable, and then choose the variable you want to insert.

The variable appears on the page as if you'd typed it in the document. For example, the Creation Date variable might appear as December 22, 2007. If you choose Type > Show Hidden Characters, the variable instance is surrounded by a box using the current layer color.

Note: Text variables do not break across lines.

[To the top](#)

Delete, convert, and import text variables

Use the Text Variables dialog box to delete, convert, and import text variables.

Delete text variables

If you want to delete an instance of a text variable inserted in a document, simply select the variable and press Backspace or Delete. You can also delete the variable itself. When you do so, you can decide how to replace the variables inserted in the document.

1. Choose Type > Text Variables > Define.
2. Select the variable, and then click Delete.
3. Specify how the variable will be replaced by specifying a different variable, converting the variable instances to text, or deleting the variable instances altogether.

Convert text variables to text

- To convert a single instance, select the text variable in the document window, and then choose Type > Text Variables > Convert Variable To Text.
- To convert all instances of the text variable in the document, choose Type > Text Variables > Define, select the variable, and then click Convert To Text.

Import text variables from another document

1. Choose Type > Text Variables > Define.
2. Click Load, and then double-click the document that has the variables you want to import.
3. In the Load Text Variables dialog box, make sure that a check mark appears next to the variables you want to import. If any existing variable has the same name as one of the imported variables, choose one of the following options under Conflict With Existing Text Variable, and then click OK:

Use Incoming Definition Overwrites the existing variable with the loaded variable and applies its new attributes to all text in the current document that used the old variable. The definitions of the incoming and existing variables are displayed at the bottom of the Load Text Variables dialog box so that you can view a comparison.

Auto-Rename Renames the loaded variable.

4. Choose OK, and then click Done.

 *You can also copy variables to other documents when you synchronize a book file.*

Adobe also recommends

 Twitter™ and Facebook posts are not covered under the terms of Creative Commons.

[Legal Notices](#) | [Online Privacy Policy](#)

Linked content | CC, CS6

Content Collector tools

Place and link

Specify link options

Custom Style Mapping

Update a linked item

Replicating content across various pages is no easy task; copy-pasting can be cumbersome and time consuming. Use linked content features to manage multiple versions of content. You can place and link content within the same document or even across different documents. Linked content makes it easier to support emerging workflows, where for example, you design for vertical and horizontal layouts. Linked content also works well for traditional print and publishing workflows, where you synchronize boilerplate text on different pages or documents.

Linked content behaves similar to traditional links. See [Use the Links panel](#) for an overview. You can designate an object as parent, and then place it at other places as child objects. Whenever you update the parent object, the child objects are flagged and you can update them to synchronize with the parent.

You can place and link objects using either the [Content Collector tools](#), or choose [Edit > Place and Link](#) menu command.



The  icon displays on the upper-left corner of linked object. The item is displayed as linked object in the Links panel.

[To the top](#)

Content Collector tools

Content Collector and Placer tools let you duplicate page items and place them on open InDesign documents. As content is collected, it is displayed in the Content Conveyor. Use Content Conveyor to easily and quickly place and link multiple page items within and across open documents.

Click  in the toolbox to open the Content Conveyor.

- Use Content Collector  tool to select an object and add it to the conveyor
- Use Content Placer  to place page object on a page

 *Press B to toggle between Content Collector and Content Placer tool.*

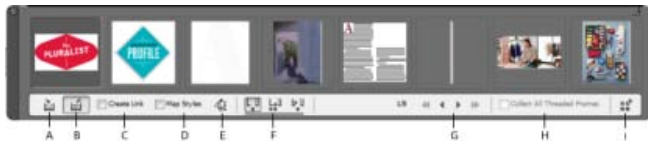

Content Conveyor

A. Content Collector tool **B.** Content placer tool **C.** Create link **D.** Map styles **E.** Edit Custom Style Mapping **F.** Place options **G.** Browse **H.** Collect All Threaded Frames **I.** Load Conveyor

Content Collector Use the Content Collector to add page items to the Content Conveyor.

Content Placer Use the Content Placer to place the items from the Content Conveyor to the document. When you select this tool, the current item is added to the place gun.

Create Link Enable Create Link to link the placed item to the original location of the collected item. You can manage the links using the Links

panel.

Map Styles Map paragraph, character, table, or cell styles, between the original and placed items. By default, style names are used for mapping. See [Custom style mapping](#).

Edit Custom Style Mapping Define custom style mapping between the original and placed items. Map the styles to automatically replace original styles in the placed item.

Place Options Specify the Conveyor options while placing items.

- Remove items from the conveyor after you place them
- Place the current item multiple times. The item remains loaded in the place gun.
- Place the item and move to the next item. The item is however kept in the conveyor.

Browse Navigate through the items in the Content Conveyor.

Collect All Threaded Frames Enable this option to collect all threaded frames. The story and all frames are collected. If this option is disabled, the story is collected in a single frame.

Load Conveyor Use  to load the conveyor with items.

- Selection: Use this option to load all selected items
- Pages: Use this option to load all items on the specified pages
- All: Use this option to load items from all pages and pasteboard

Enable Create Single set to group all the items in a single set.

You can collect individual page items, or collect related items as "sets." In some cases InDesign automatically creates sets to preserve the relational integrity of the page items.

The following are a few method of collecting items as sets, some manual and some automatic:

- Marquee select a number of items
- Use the Load Conveyor option and then select range of pages or all document content or selected items and items will be accordingly collected in a set.
- Collect an item that has related content such as a part of an interactive button that has other items and states associated with it, it will collect all related items in a set (this set will always drop in one gesture)
- Collect a text box with threaded text spanning into other objects and 'collect All Threaded Text Frames' checkbox is checked on the conveyor, it will pick all threaded text boxes into a set.

[To the top](#)

Place and link

1. Select a page item by either selecting the frame or place the insertion cursor in the text. You can also select multiple items by using Shift+Click.
2. Choose Edit > Place and Link. The cursor is loaded with the items, and the items display in the Content Conveyor.
3. Click on a page or draw a frame to place the linked item.

[To the top](#)

Specify link options

1. In the Links panel, select the linked item.

- From the Links panel menu, choose Link Options.

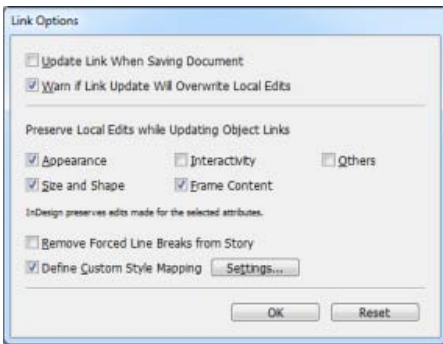

 Press *Alt* (Windows) or *Option* (Mac OS) to change the Cancel button to Reset. Click Reset to revert to default options.

- Select the options as required:

Update Link When Saving Document Enable this option to update the link when you save the document.

Warn if Link Update Will Overwrite Local Edits Enable this option to show a warning message if updating the link will overwrite any local edits made to the linked object.

Preserve Local Edits while Updating Object Links Select from the available categories to preserve local edits while updating links.

Category	Examples
Appearance	Object style attributes such as Stroke, Fill, Effects. This excludes any text or text frame related attributes, such as overprinting, non-printing settings etc
Size and Shape	Height, width, transforms, text frame attributes, and other column size attributes
Interactivity	Animation, object States, button actions
Frame Content	Image, video, content placed or pasted into frames, and effects and settings applied directly to such objects.
Others	Attributes excluded from other categories, such as text wrap on frames, object export options; text frame attributes such as , baseline options, auto-size options, vertical justification and so on.

Remove Forced Line Breaks from Story Enable to remove any forced line breaks in the story. Removing line breaks lets the text reflow smoothly in the linked frame if it is resized or reformatted.

Define Custom Style Mapping Enable this option if you want to map styles, and automatically apply another style to the linked content instead. See [Custom style mapping](#).

 To specify default link options, with all documents closed, open the links panel menu and choose Link Options.

[To the top](#)

Custom Style Mapping

Text styles (paragraph, character, table, cell) or style groups can be mapped to different styles while linking. The mapped styles are automatically applied to the linked content, instead of the original styles applied to the parent. Custom style mapping comes in handy, for example, when you want to use sans serif fonts for digital and serif fonts for print publications. Or if you want, vary the text style between the horizontal and vertical layouts.

To define custom style mapping, do one of the following:

- In the Link Options dialog box (Links panel > Link Options), enable Define Custom Style Mapping and then click Settings.
- Click  in the Content Conveyor.

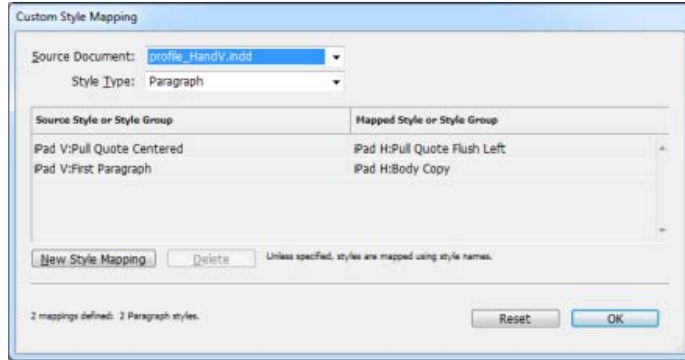

Custom Style Mapping



1. Select a source document and Style type.
2. Click New Syle Mapping.
3. Choose source and mapped styles or style groups from the list

 Press **Alt** (Windows) or **Option** (Mac OS) to change the Cancel button to Reset. Click Reset to revert to default options.

[To the top](#)

Update a linked item

If an original item is modified,  symbol displays over the frame and in the Links panel. To update do one of the following:

- Click  near the top-left of the frame
- In the Links panel, double-click  symbol

If you have made local edits to a child item, the edits are overwritten with content from the original item. If you set Warn if Link Update Will Overwrite Local Edits, a warning message displays.

 Use the Link Info pane to determine if you've made local edits to the story; story status displays "Text Modified" if you've made local edits.

 Twitter™ and Facebook posts are not covered under the terms of Creative Commons.

[Legal Notices](#) | [Online Privacy Policy](#)

Glyphs and special characters

Glyphs panel overview

Insert glyphs and special characters

Create and edit custom glyph sets

Use quotation marks

Insert white space characters

About Adobe SING Glyphlet Manager

[To the top](#)

Glyphs panel overview

Enter glyphs by way of the Glyphs panel. The panel initially shows glyphs in the font where the cursor is located, but you can view a different font, view a type style in the font (for example, Light, Regular, or Bold), and make the panel display a subset of glyphs in the font (for example, math symbols, numbers, or punctuation symbols).

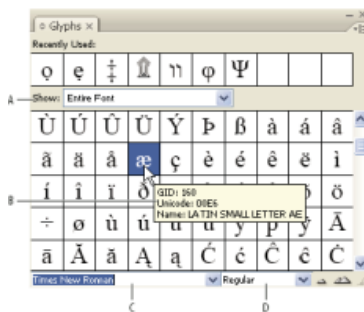

Glyphs panel

A. Show subset of glyphs **B.** Tool tip **C.** Font list **D.** Font style

By moving the pointer over a glyph, you can read its CID/GID value, Unicode value, and name in a tool tip.

Open the Glyphs panel

- Choose Type > Glyphs or Window > Type & Tables > Glyphs.

Change the Glyphs panel view

- Click the cycle widget (it's located to the left of the word "Glyphs" on the Glyphs panel) to change views of the panel. Clicking the widget presents these views in succession: the collapsed panel, the entire panel, and the panel without recently used glyphs.
- Click the Zoom In or Zoom Out buttons in the lower-right corner of the Glyphs panel.
- Resize the Glyphs panel by dragging the lower-right corner.

Filter the glyphs that appear

- Do one of the following on the Show list to determine which glyphs appear on the Glyphs panel:

- Choose Entire Font to display all glyphs available in the font.
- Choose an option below Entire Font to narrow the list to a subset of glyphs. For example, Punctuation displays only punctuation glyphs; Math Symbols narrows the choices to mathematical symbols.

Sort glyphs in the Glyphs panel

- Choose By CID / GID or By Unicode to determine how glyphs are sorted in the Glyphs panel.

[To the top](#)

Insert glyphs and special characters

A *glyph* is a specific form of a character. For example, in certain fonts, the capital letter A is available in several forms, such as swash and small cap. You can use the Glyphs panel to locate any glyph in a font.

OpenType fonts such as Adobe Caslon™ Pro provide multiple glyphs for many standard characters. Use the Glyphs panel when you want to insert these alternate glyphs in your document. You can also use the Glyphs panel to view and insert OpenType attributes such as ornaments, swashes, fractions, and ligatures.

Insert special characters

You can insert common characters such as em dashes and en dashes, registered trademark symbols, and ellipses.

1. Using the Type tool, position the insertion point where you want to insert a character.
2. Choose Type > Insert Special Character, and then select an option from any of the categories in the menu.

If special characters that you use repeatedly do not appear on the list of special characters, add them to a glyph set that you create.

Insert a glyph from a specified font

1. Using the Type tool, click to place the insertion point where you want to enter a character.
2. Choose Type > Glyphs to display the Glyphs panel.
3. To display a different set of characters in the Glyphs panel, do any of the following:
 - Select a different font and type style, if available. From the Show menu, choose Entire Font. Or, if you selected an OpenType font, choose from a number of OpenType categories.
 - Choose a custom glyph set from the Show menu. (See [Create and edit custom glyph sets.](#))
4. Scroll through the display of characters until you see the glyph you want to insert. If you selected an OpenType font, you can display a pop-up menu of alternate glyphs by clicking and holding the glyph box.
5. Double-click the character you want to insert. The character appears at the text insertion point.

Insert a recently used glyph

InDesign tracks the previous 35 distinct glyphs you inserted and makes them available under Recently Used in the first row of the Glyphs panel (you have to expand the panel to see all 35 glyphs on the first row).

- Do one of the following:
 - Double-click a glyph under Recently Used.
 - Choose Recent Glyphs on the Show list to display all recently used glyphs in the main body of the Glyphs panel, and then double-click a glyph.

Clear recently used glyphs

- To clear a selected glyph from the Recently Used section, right-click (Windows®) or Control-click (Mac OS) a glyph in the Recently Used section, and then choose Delete Glyph From Recently Used.
- To clear all recently used glyphs, choose Clear All Recently Used.

Replace a character with an alternate glyph

When a character includes alternate glyphs, it appears in the Glyphs panel with a triangle icon in the lower-right corner. You can click and hold the character in the Glyphs panel to display a pop-up menu of the alternate glyphs, or you can display alternate glyphs in the Glyphs panel.



Selecting alternate glyphs in OpenType font

1. Choose Type > Glyphs to display the Glyphs panel.
2. Select Alternates For Selection from the Show list.
3. Using the Type tool, select a character in your document.
4. Do one of the following to replace the selected character in the document:
 - Double-click a glyph in the Glyphs panel.
 - Select a glyph on the menu.

Display OpenType glyph attributes in the Glyphs panel

For easy selection, the Glyphs panel allows you to display characters for only the selected OpenType attributes. You can select various options from the Show menu in the Glyphs panel.

Note: Do not confuse these options with those that appear on the Glyphs panel menu, which let you apply forms to selected text. (See Apply OpenType font attributes.)

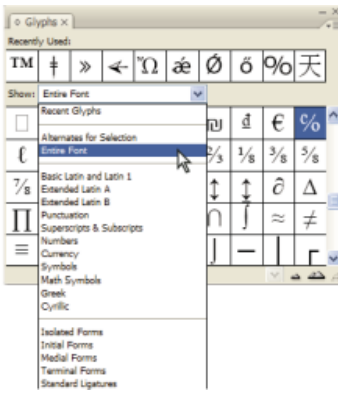

Show menu options in the Glyphs panel

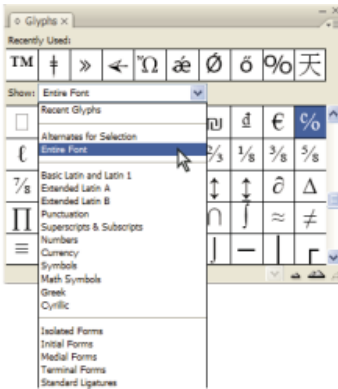

Show menu options in the Glyphs panel

1. In the Glyphs panel, choose an OpenType font from the font list.
2. Choose an option from the Show menu.

The options displayed vary depending on which font is selected. For information on applying OpenType font attributes, see [Apply OpenType font attributes](#). For more information on OpenType fonts, see www.adobe.com/go/opentype.

Highlight alternate glyphs in the text

1. Choose Edit > Preferences > Composition (Windows) or InDesign > Preferences > Composition (Mac OS).
2. Select Substituted Glyphs, and then click OK. Substituted glyphs in the text are highlighted in nonprinting yellow.

[To the top](#)

Create and edit custom glyph sets

A *glyph set* is a named collection of glyphs from one or more fonts. Saving commonly used glyphs in a glyph set prevents you from having to look for them each time you need to use them. Glyph sets are not attached to any particular document; they are stored with other InDesign preferences in a separate file that can be shared.

You can determine whether the font is remembered with the added glyph. Remembering fonts is useful, for example, when you are working with dingbat characters that may not appear in other fonts. If a glyph's font is remembered, but the font is missing, the font's square appears in pink in the Glyphs panel and the Edit Glyph Set dialog box. If a font is not remembered with an added glyph, a "u" appears next to the glyph, indicating that the font's unicode value determines the appearance of the glyph.

Create a custom glyph set

1. Choose Type > Glyphs.
2. Do one of the following:
 - From the Glyphs panel menu, choose New Glyph Set.
 - Open the context menu on the Glyphs panel and choose New Glyph Set.
3. Type the name of the glyph set.
4. Choose the insert order in which glyphs will be added to the glyph set, and click OK:

Insert At Front Each new glyph is listed first in the set.

Append At End Each new glyph is listed last in the set.

Unicode Order All glyphs are listed by the order of their unicode values.

5. To add glyphs to the custom set, select the font containing the glyph at the bottom of the Glyphs panel, click the glyph to select it, and then choose the name of the custom glyph set from the Add To Glyph Set menu on the Glyphs panel menu.

View a custom glyph set

- Do one of the following on the Glyphs panel:
 - Choose the glyph set on the Show list.
 - On the Glyphs panel menu, choose View Glyph Set, and then the name of the glyph set.

Edit custom glyph sets

1. Choose Edit Glyph Set from the Glyph panel menu, and then choose the custom glyph set.
2. Select the glyph you want to edit, do any of the following, and then click OK:
 - To bind the glyph to its font, select Remember Font With Glyph. A glyph that remembers its font ignores the font applied to the selected text in the document when the glyph is inserted into that text. It also ignores the font specified in the Glyph panel itself. If you deselect this option, the Unicode value of the current font is used.
 - To view additional glyphs, choose a different font or style. If the glyph is not defined with a font, you cannot select a different font.
 - To remove a glyph from the custom glyph set, choose Delete From Set.
 - To change the order in which glyphs are added to the set, choose an Insert Order option. Unicode Order is not available if Insert At Front or Append At End was selected when the glyph set was created.

Delete glyphs from custom glyph sets

1. In the Glyphs panel, choose the Custom Glyph Set from the Show menu.
2. Right-click (Windows) or Control-click (Mac OS) a glyph, and then choose Delete Glyph From Set.

Delete custom glyph sets

1. Do one of the following:
 - From the Glyphs panel menu, choose Delete Glyph Set.
 - From the context menu, choose Delete Glyph Set.
2. Click the name of a custom glyph set.
3. Click Yes to confirm.

Save and load glyph sets

Custom glyph sets are stored in files kept in the Glyph Sets folder, a subfolder of the Presets folder. You can copy glyph set files to other computers and in so doing make custom glyph sets available to others. Copy glyph set files to and from these folders to share them with others:

Mac OS Users\[username]\Library\Preferences\Adobe InDesign\[Version]\[Language]\Glyph Sets

Windows XP Documents and Settings\[username]\Application Data\Adobe\InDesign\[Version]\[Language]\Glyph Sets

Windows Vista and Windows 7 Users\[username]\AppData\Roaming\Adobe\InDesign\[Version]\[Language]\Glyph Sets

[To the top](#)

Use quotation marks

You can specify different quotation marks for different languages. These quotation mark characters appear automatically during typing if the Use Typographer's Quotes option is selected in the Type section of the Preferences dialog box.

Specify which quotation marks to use

1. Choose Edit > Preferences > Dictionary (Windows) or InDesign > Preferences > Dictionary (Mac OS).
2. Choose a language from the Language menu.
3. Do any of the following, and then click OK:
 - For Double Quotes, select a pair of quotation marks, or type the pair of characters you want to use.
 - For Single Quotes, select a pair of quotation marks, or type the pair of characters you want to use.

Insert straight quotation marks

- Do one of the following:
 - Choose Type > Insert Special Character > Quotation Marks > Straight Double Quotation Marks or Straight Single Quotation Mark (Apostrophe).
 - Deselect the Use Typographer's Quotes option in the Type section of the Preferences dialog box, and then type the quotation mark or apostrophe.
 - Press Shift+Ctrl+Alt+' (Windows) or Shift+Command+Option+' (Mac OS) to switch between turning on and off the Use Typographer's Quotes preferences option.

 The character frequently used to indicate feet, arcminutes, or minutes of time is the prime mark. It looks like a slanted apostrophe. The character frequently used to indicate inches, arcseconds, or seconds of time is the double prime mark. These symbols are different from apostrophes and double quotation marks. Some fonts include the prime and double prime marks. Use the Glyphs panel to insert these marks. If the font doesn't have a prime or double prime mark, insert the straight quotation mark, and italicize it.

[To the top](#)

Insert white space characters

A *white space character* is a blank space that appears between characters. You can use white-space characters for many different purposes, such as preventing two words from being broken at the end of a line.

1. Using the Type tool, position the insertion point where you want to insert a certain amount of white space.
2. Choose Type > Insert White Space, and then select one of the spacing options (such as Em Space) in the context menu.

 Representative symbols of the white-space characters appear when you choose Type > Show Hidden Characters.

White space options

The following options appear on the Type > Insert White Space menu:

Ideographic Space

This is a space that is based on a full-width character in Asian languages. It wraps to the next line as with other full-width characters.

Em Space

Equal in width to the size of the type. In 12-point type, an em space is 12 points wide.

En Space

One-half the width of an em space.

Nonbreaking Space

The same flexible width as pressing the spacebar, but it prevents the line from being broken at the space character.

Nonbreaking Space (Fixed Width)

A fixed width space prevents the line from being broken at the space character, but does not expand or compress in justified text. The fixed width space is identical to the Nonbreaking Space character inserted in InDesign CS2.

Third Space

One-third the width of an em space.

Quarter Space

One-fourth the width of an em space.

Sixth Space :

One-sixth the width of an em space.

Flush Space ⁂

Adds a variable amount of space to the last line of a fully justified paragraph, useful for justifying text in the last line. (See Change Justification settings.)

Hair Space ⁄

One-twenty-fourth the width of an em space.

Thin Space ⁄

One-eighth the width of an em space. You may want to use a thin space on either side of an em dash or en dash.

Figure Space #

Same width as a number in the typeface. Use a figure space to help align numbers in financial tables.

Punctuation Space |

Same width as an exclamation point, period, or colon in the typeface.

[To the top](#)

About Adobe SING Glyphlet Manager

The Adobe SING Glyphlet Manager is a utility for installing and searching for glyphlets. It is not included in Adobe Creative Suite 5.

Adobe also recommends

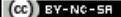
 Twitter™ and Facebook posts are not covered under the terms of Creative Commons.

[Legal Notices](#) | [Online Privacy Policy](#)

Formatting CJK characters

- [Apply shatai to text](#)
- [Rotate characters](#)
- [Adjust aki before and after characters](#)
- [Use tate-chu-yoko](#)
- [Add Ruby to text](#)
- [Apply kenten](#)
- [Align text of different sizes](#)

[To the top](#)

Apply shatai to text

In traditional typesetting technology, characters were slanted by using a lens to distort the glyphs when being set on film. This oblique style is known as *shatai*. Shatai is distinct from a simple slant of the glyphs, because it also scales the glyphs. You can adjust the magnification or angle of text you want to slant from the center point, without changing the height of the glyph, using the shatai feature in InDesign.

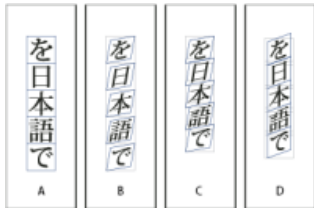

Shatai

A. No scale applied **B.** Magnification 30%, 45 shatai **C.** Selecting the Adjust Tsume option **D.** Selecting the Adjust Rotation option

1. Select text.
2. Select Shatai from the Character panel menu or Control panel menu.
3. Specify the following options, and click OK:
 - Specify the degree of skew in Magnification (In traditional typesetting technology terms, 10% magnification is lens 1, and 40% magnification is lens 4).
 - Set the angle of obliqueness to 30, 45, or 60, in Angle.
 - Select Adjust Rotation to rotate the glyphs, and display horizontal lines horizontally for horizontal text, and vertical lines vertically for vertical text.
 - Select Adjust Tsume to apply jidori.



 You can fine tune the rotated oblique effect for individual characters, after applying shatai to text.

[To the top](#)

Rotate characters

1. Select the characters.
2. In the Character panel, type a value for Character Rotation  Specify a minus value to rotate the character to the right (clockwise).

Adjust aki before and after characters

1. Select opening parenthesis or closing parenthesis with the type tool.
2. Choose the amount of aki you want to add from the Mojikumi Before Character  or Mojikumi After Character  pop-up menu, in the Character panel.

For example, if you specify 2bu, half a full-width space is added, and if you specify 4bu, a quarter of a full-width space is added. This aki will not be adjusted when the line is set to full justification. Adjusting aki is especially useful to override Mojikumi Akiryo Settings for certain characters.

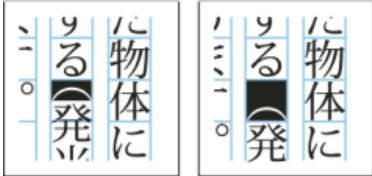

Adding aki before opening parenthesis

Use tate-chu-yoko

Using tate-chu-yoko (also known as kumimoji or renmoji) is an option to make a part of the text horizontal, in vertical text. It is easier to read half-width characters such as numbers, dates, and short foreign words in a vertical text frame, by rotating the text.

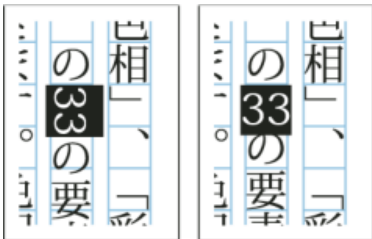

Before and after applying tate-chu-yoko

You can move text left, right, up, and down when you turn on the Tate-chu-yoko option. You can also set Auto Tate-chu-yoko for special half-width characters. Auto Tate-chu-yoko is set in the paragraph attributes.

 Use *tsume* or *tracking* in the Character panel to adjust the character spacing for Tate-chu-yoko.

Apply tate-chu-yoko

1. Select the text to which you want to apply tate-chu-yoko.
2. Do one of the following:
 - Choose Tate-chu-yoko from the Character panel menu or Control panel menu.
 - Choose Tate-chu-yoko Settings from the Character panel menu or Control panel menu, choose Tate-chu-yoko in the Tate-chu-yoko

dialog box, and click OK.

 If multiple instances of *tate-chu-yoko* appear next to each other, use the *Non-joiner* character to keep them separate. Choose *Type > Insert Special Character > Other > Non-joiner*.

Remove *tate-chu-yoko*

1. Select the text to which you want to apply *tate-chu-yoko*.
2. Do one of the following:
 - Choose and cancel *Tate-chu-yoko* from the *Character* panel menu or *Control* panel menu.
 - Choose *Tate-chu-yoko Settings* from the *Character* panel menu, deselect *Tate-chu-yoko* in the *Tate-chu-yoko* dialog box, and then click OK.

Change *tate-chu-yoko* settings

1. Choose *Tate-chu-yoko Settings* from the *Character* panel menu.
2. Specify a value for moving the text up or down in *X Offset*. If you specify a plus value, the text will move up, and if you specify a minus value, it will move down.
3. Specify a value for moving the text left or right in *Y Offset*. If you specify a plus value, the text will move to the right, and if you specify a minus value, it will move to the left.

Set Auto *Tate-chu-yoko* for specific paragraphs

1. Select the text to be set to Auto *Tate-chu-yoko*, or place the text insertion point in the paragraph.
2. Choose Auto *Tate-chu-yoko* from the *Paragraph* panel menu.
3. In *KumiNumber*, specify the number of successive half-width characters that you want to rotate to vertical orientation. For example, if this is set to 2, the character string "123" will not rotate, while "12" will.
4. If you want to apply *tate-chu-yoko* to roman text, select *Include Roman Characters*, and click OK.

[To the top](#)

Add Ruby to text

In Japanese, Ruby (also known as *furigana*) is normally used to show the kanji yomi in hiragana. In Simplified Chinese, Ruby is called Pinyin, while in Traditional Chinese, Ruby is called Chuyin. InDesign provides full support to Japanese Ruby and limited support to Chinese Pinyin or Chuyin. You can adjust Ruby settings to specify Ruby location, size, or color. Furthermore, when the ruby is longer than the parent you can specify the ruby distribution. You can also apply *tate-chu-yoko* to Ruby.



Ruby on horizontal text (left), and ruby to the right of vertical text (right)

When the parent to which you want to attach ruby covers two lines, the ruby will follow when the parent moves to the next line.

Note: In some instances, such as when applying a style that includes a variable, Ruby characters may be removed.

1. Select the text to which you want to attach ruby. You cannot attach ruby when there are forced line breaks in the selected text.
2. Select Ruby > Ruby from the Character panel menu or Control panel menu.
3. Enter the ruby characters in Ruby.
4. Change Ruby settings by clicking an option on the left side of the dialog box and specifying settings.
5. Click OK.

Ruby settings

The following options appear in the different panels of the Ruby dialog box.

Ruby Placement and Spacing

- From the Type menu, choose Per-Character or Group Ruby. When Per Character Ruby is selected, enter a half or full width space when inputting Ruby characters to separate them in line with their parent characters. For "hakunetsutou" for example, enter as "haku netsu tou" (example of a word composed of Japanese characters and its phonetic spelling is given).

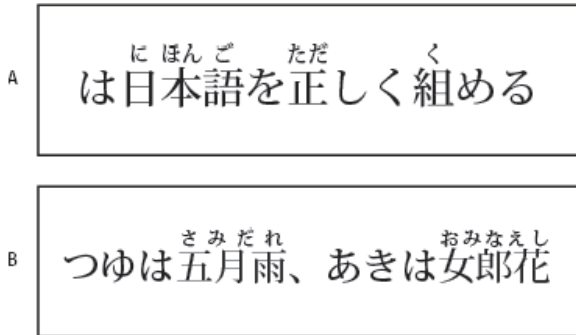

Ruby

- From the Alignment menu, specify the position of the Ruby characters. You can check the position with the graphic shown in the sample field.
- To attach ruby above horizontal text or to the right of vertical text, select Above/Right, and to attach below horizontal text or to the left of vertical text, select Below/Left in Placement.
- Specify the spacing between the ruby and the parent in XOffset and YOffset. When you enter a minus value, the ruby moves closer to the parent.

Ruby Font and Size

- Select a font family and font style in Font.
- Specify the size of the ruby characters in Size. The default ruby size is half the size of the parent.
- Specify the scale for the height and width of the ruby characters in Horizontal Scale and Vertical Scale.
- Select Use Open Type Pro Ruby Glyphs to use alternate glyphs for ruby (when possible). Specific kana characters are available for some Open Type Pro fonts. When you select this option, the specific font for ruby characters, and not the standard kana font, will be used.

- In KumiNumber, specify the number of successive half-width characters that you want to rotate to vertical orientation. For example, if this is set to 2, the character string "123" will not rotate, while "12" will.
- Select Include Roman Characters to apply tate-chu-yoko to roman text.
- Select Scale to Fit to force the tate-chu-yoko to have the same dimensions (1 em x 1 em) in the ruby string, either using an OpenType feature or scaling the glyphs.

Adjustment When Ruby Is Longer Than Parent

- With Overhang, when the total Ruby width is greater than that of their parent characters, the specified Ruby will overflow widthways into the space above characters either side of the parents. For Japanese, character types compatible with Overhang comply with the JISx4051-1995 specification.
- Specify the parent character spacing necessary for attaching ruby in Spacing. When you select a different option, the graphics displayed in the sample field are updated.
- To automatically adjust the ruby character width, select Char Width Scaling, and specify the compression scale for the width of the ruby characters.
- Select Auto Align at Line Edges to align the parent with the start and end of the line.

Ruby Color

- Select a color swatch in the list box.
- Specify the degree of tinting and line weight, as necessary.
- Select Overprint Fill or Overprint Stroke to set filling or stroke overprint for ruby characters.

(See Determining when to overprint manually.)

[To the top](#)

Apply kenten

Kenten (also known as *Boten*) are points which you attach to text you want to highlight. You can select the type of points from existing kenten forms, or specify customized kenten characters. You can also specify the position, scale, and color by adjusting the kenten settings.

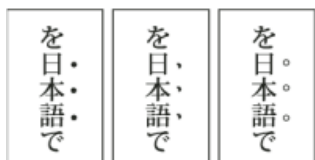

Small black circle kenten, black sesame kenten, and small white circle kenten applied to text

Apply kenten

1. Choose the characters you want to highlight.
2. Choose a kenten character, such as Fisheye or White Circle, from Kenten in the Character panel menu or Control panel menu.

Change kenten settings and color

1. Choose Kenten > Kenten from the Character panel menu or Control panel menu.

2. For Kanten Settings, specify the options below:

Kanten Type Select a kanten character, such as Fisheye or White Circle. Choose Custom to specify a custom character. You can enter characters directly, or you can specify a character code value for the specified character set.

Position Specify the spacing between the kanten and characters.

Location Select Above/Right to attach kanten above horizontal text or to the right of vertical text, and Below/Left to attach below horizontal text or to the left of vertical text.

Size Specify the size of the kanten character.

Align Specify whether the kanten should be displayed in the center (Center) or to the left (Left) (above for vertical text) of the character's embox.

H/Scale and V/Scale Specify the scale for the height and width of the kanten character.

3. To change the color of the kanten, choose Kanten Color from the list box, and then specify the options below:

- Select a color swatch from the list box.
- Specify the degree of tinting and line weight, as necessary.
- Select Overprint Fill or Overprint Stroke to set filling or stroke overprint for kanten characters.
(See Determining when to overprint manually.)

4. Click OK.

[To the top](#)

Align text of different sizes

You can specify how to align text to the largest characters in a line using the Character Alignment option, when positioning characters of different sizes in 1 line. It is possible to align characters to the top, center or bottom of the embox (right, center, and left for vertical frames), to the roman baseline, and to the top or bottom of the ICF box (right or left for vertical frames). *ICF* (Ideographic Character Face) is the average height and width used by the font designer to design the ideographic characters which comprise a font.

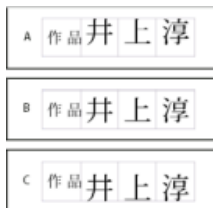

Align different sizes

A. Align different size letters above full space letters **B.** Align different size letters in the middle of full space letters **C.** Align different size letters below full space letters

Note: The Character Alignment option is not effective, even if applied, when all characters are the same size in a line.

1. Select a range of text or lines for the characters you want to align, or select a text frame using the selection tool.
2. Choose one of the following options from Character Alignment in the Character panel menu or Control panel menu.

- Roman Baseline aligns the small characters in a line to the large character baseline grid.
- Embox Top/Right, Center, or Embox Bottom/Left align the small characters in a line to the specified position of the large characters embox. In vertical text frames, Embox Top/Right aligns the text to the right of the embox, and Embox Bottom/Left aligns the paragraph to the left of the embox.
- ICF Top/Right and ICF Bottom/Left align the small characters in a line to the ICF specified by the large characters. In vertical text frames, ICF Top/Right aligns the text to the right of the ICF, and ICF Bottom/Left to the left of the ICF.

Adobe also recommends

 Twitter™ and Facebook posts are not covered under the terms of Creative Commons.

[Legal Notices](#) | [Online Privacy Policy](#)

Creating type on a path

[Create type on a path](#)

[Edit or delete type on a path](#)

[Adjust the type on a path position](#)

[Apply an effect to type on a path](#)

[Add anchored objects to type on a path](#)

[To the top](#)

Create type on a path

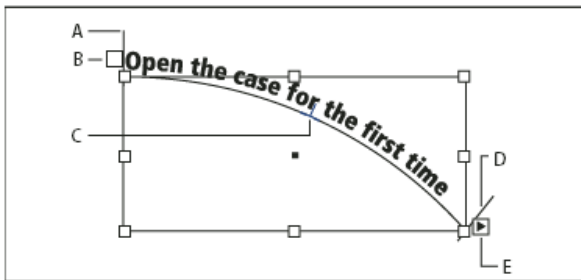

You can format text to flow along the edge of an open or closed path of any shape. Apply options and effects to type on a path: Slide it along the path, flip it over to the other side of the path, or use the shape of the path to distort the characters. Type on a path has an in port and an out port just like other text frames, so you can thread text to and from it.

You can include only one line of type on a path, so any type that won't fit on the path will be overset (hidden), unless you've threaded it to another path or text frame. You can add inline or above line anchored objects to type on a path. You can't create type on a path using compound paths, such as those that result from using the Create Outlines command.



Type on a path

A. Start bracket **B.** In port **C.** Center bracket **D.** End bracket **E.** Out port indicating threaded text

1. Select the Type On A Path tool . (Click and hold the Type tool to display a menu containing the Type On A Path tool.)
2. Position the pointer on the path until a small plus sign appears next to the pointer , and then follow these steps:
 - To type using default settings, click the path. An insertion point appears at the start of the path by default. If the current default paragraph settings specify an indent, or any alignment other than left, the insertion point may appear somewhere other than at the start of the path.
 - To confine the text to a specific portion of the path, click the path where you would like the text to start, and drag along the path to where you want the text to end, then release the mouse. (For information about changing the start and end position of text, see [Adjust the type on a path position.](#))



Changing location of type on path

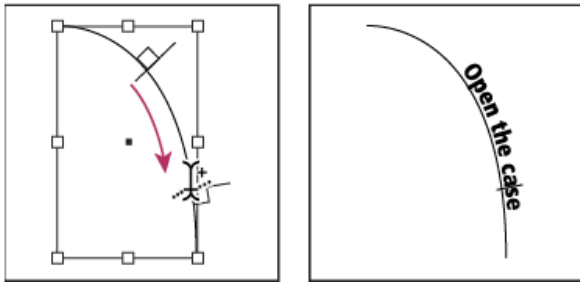

Changing location of type on path

Note: If neither clicking nor dragging seems to work, make sure that the small plus sign appears next to the Type On A Path tool.

3. Type the text you want. If you clicked to place the insertion point on the path, type will appear along the entire length of the path. If you dragged, type will appear only along the length you dragged.

Note: If the path was originally visible, it remains visible after you add type to it. To hide the path, select it with the Selection or Direct Selection tool, and then apply a fill and stroke of None.

[To the top](#)



Edit or delete type on a path

You can apply character and paragraph options to type on a path. However, paragraph rules and paragraph spacing options have no effect on type on a path. The alignment setting in the Paragraph panel controls the alignment of type on a path.

Edit and format path-type characters

1. Using the Type On A Path tool, do one of the following:
 - To add an insertion point, click between any two characters in the type on a path.
 - To select characters, drag through the type on a path.
2. Edit and format the text as needed.

Delete type from a path

1. Using the Selection tool  or Direct Selection tool , select one or more type-on-a-path objects.
2. Choose Type > Type on a Path > Delete Type From Path.

If the path text is threaded, type moves to the next threaded text frame or type-on-a-path object. If the path text isn't threaded, text is deleted. The path remains, but loses any type-on-a-path attributes—all brackets, in and out ports, and threading properties are removed.

Note: If the path's fill and stroke are set to None, the path is invisible after you delete the type. To make the path visible, press the D key immediately after you choose Type > Type on a Path > Delete Type From Path. This applies the default fill and stroke to the selected path.

Tighten character spacing around sharp turns and acute angles

1. Using the Selection tool or the Type tool, select the type on a path.

2. Choose Type > Type on a Path > Options, or double-click the Type On A Path tool.
3. For Spacing, type a value in points. Higher values remove the extra space from between characters positioned on sharp curves or angles.

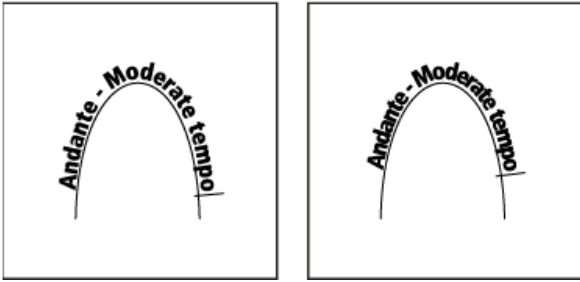

Type on a path before (left) and after (right) applying spacing adjustment



Note: The Spacing value compensates for the way characters fan out around a curve or sharp angle. It has no effect on characters positioned on straight segments. To change spacing of characters anywhere along the path, select them, and then apply kerning or tracking.

[To the top](#)

Adjust the type on a path position

You can change the start or end position of type on a path, slide type, and change the path position in other ways.

Change the start or end position of type on a path

1. Using the Selection tool , select the type on a path.
2. Position the pointer over the path type's start or end bracket until a small icon appears next to the pointer . Do not position it over the bracket's in port or out port.

 Zoom in on the path to more easily select the bracket.

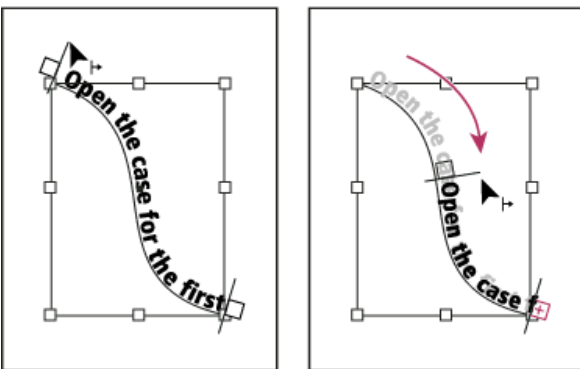

3. Drag the start or end bracket along the path.



Position the pointer on start or end bracket, and then drag to reposition boundary of type on a path.



Note: If you apply a paragraph indent value, it's measured from the start and end brackets.

Slide type along a path

1. Using the Selection tool , select the type on a path.
 2. Position the pointer over the path type's center bracket until a center bracket icon appears next to the pointer .
-  *Zoom in on the path to more easily select the bracket.*
3. Drag the center bracket along the path.

Note: *The text won't move if both the start and end brackets are at the ends of the path. To create some space for dragging text, drag the start or end bracket away from the ends of the path.*

Flip type on a path

1. Click the Selection tool , and select the type on a path.
2. Position the pointer over the type's center bracket until a center bracket icon appears next to the pointer .
3. Drag the center bracket across the path.

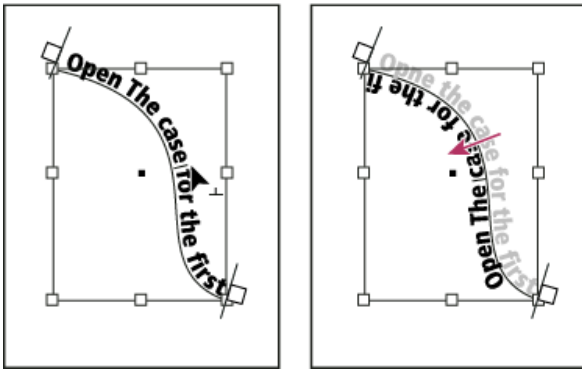

Position pointer on center bracket, and then drag across path to flip type.

You can also flip type on a path using a dialog box. Using the Selection tool or the Type tool, select the type on a path. Choose Type > Type on a Path > Options. Select the Flip option, and then click OK.

[To the top](#)

Apply an effect to type on a path

1. Using the Selection tool or the Type tool, select the type on a path.
2. Choose Type > Type on a Path > Options, or double-click the Type On A Path tool.
3. Choose one of the following in the Effect menu, and then click OK:
 - To keep the center of each character's baseline parallel to the path's tangent, choose Rainbow. This is the default setting.

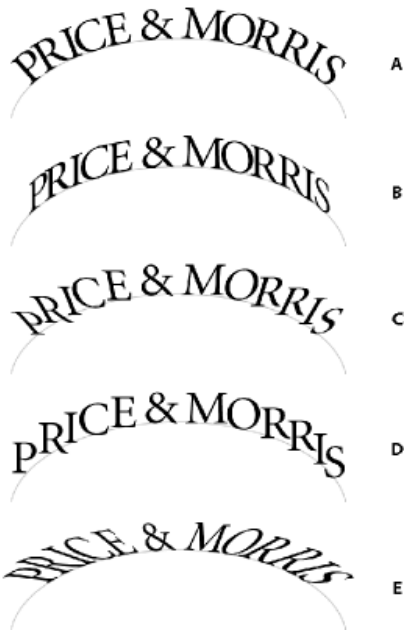

Type on a path effects

A. Rainbow effect B. Skew effect C. 3D Ribbon effect D. Stair Step effect E. Gravity effect

- To keep characters' vertical edges perfectly vertical regardless of the path shape, while letting characters' horizontal edges follow the path, choose Skew. The resulting horizontal distortion is useful for text that appears to follow waves or go around a cylinder, as on a beverage can label.
- To keep characters' horizontal edges perfectly horizontal regardless of the path shape, while keeping each character's vertical edge perpendicular to the path, choose 3D Ribbon.
- To keep the left edge of each character's baseline on the path without rotating any characters, choose Stair Step.
- To keep the center of each character's baseline on the path while keeping each vertical edge in line with the path's center point, choose Gravity. You can control this option's perspective effect by adjusting the arc of the text's path.

[To the top](#)

Add anchored objects to type on a path

1. Using the Type tool or the Type On A Path tool, click an insertion point in the text where you want the anchor for the object to appear.
2. Add the anchored object. You can add inline or above line anchored objects or frames to the path. (See Anchored objects.)

Note: The options available for above line anchored objects in a text path differ slightly from options for anchored objects in a regular text frame: the Alignment option is relative to the anchored object marker and the Space Before option is not available.

 Twitter™ and Facebook posts are not covered under the terms of Creative Commons.

[Legal Notices](#) | [Online Privacy Policy](#)

Articles (CS5.5)

[Introduction to articles](#)

[Create an article and add content to it](#)

[Add all page items in a document to an article](#)

[Managing articles](#)

[Include articles for export](#)

[To the top](#)

Introduction to articles

Articles provide an easy way to create relationships among page items. These relationships can be used to define the content to be exported to EPUB, HTML, or Accessible PDFs; and to define the order of the content. You can create articles from a combination of existing page items within a layout, including images, graphics, or text. Once an article has been created, page items can be added, removed, or reordered. Articles can be created manually by dragging one or more page items to an article in the Articles panel.

You can also add bulk content to an article. Adding selected content to selected article, or adding an entire document content to an article is supported.

Note: *The XML structure panel provides another mechanism to decide the order of the content to be exported to the ePub, HTML, and Accessible PDF exports workflows. The Articles panel is designed to be simpler, easier to use, and more accessible, for people without XML skills. However, the ability to use the XML structure panel has not been removed; it is now an option alongside the use of the Articles panel during the export process. See [Structuring documents for XML](#).*

[To the top](#)

Create an article and add content to it

1. Choose Window > Articles to open the Articles panel.

2. Select the page items to add to the article.

 *To create an empty article, don't select a page item in the layout.*

3. Do one of the following:

- Choose New Article from the Articles panel menu.
- Click Create New Article  at the bottom of the Articles panel.
- Drag story or page element to the Articles panel.

4. In the New Article dialog box, enter a name for the article.

5. Select Include When Exporting to add the article to the EPUB/HTML export output.

[To the top](#)

Add all page items in a document to an article

To add all the page items to an article:

1. Choose Window > Articles to open the Articles panel.
2. Select an article to add the items to. If you don't select an article, a new article is created.
3. Press Command (Mac OS) or Ctrl (Windows) and then click the  in the Articles panel.
4. If a New Article dialog box opens, enter a name for the article.
5. Select Include When Exporting to add the article to the EPUB/HTML export.

 *If you've selected an article, choose Add Document Content to Selected Articles from the articles panel menu.*

[To the top](#)

Managing articles

You can manage articles using the Articles panel. You can drag page elements into the Articles panel to add them to an article. Drag items in the Articles panel to change the order, or move them from one article to another.

The Articles panel pop-up menu also provides options to manage content.

[To the top](#)

Include articles for export

You can create articles and select which articles to include while exporting to EPUB or HTML. By default, all articles are selected for export.

To include an article while exporting, in the Articles panel, select the article and do one of the following:

- Select the check box next to the article.
- Choose Article Options from the Articles panel pop-up menu and then select Include When Exporting.

 Twitter™ and Facebook posts are not covered under the terms of Creative Commons.

[Legal Notices](#) | [Online Privacy Policy](#)

Anchored objects

About anchored objects

Create an anchored object

Position a custom-positioned anchored object

Working with anchored objects using drag-and-drop (CS5.5)

Selecting and copying anchored objects

View anchored object markers on the page

Reposition an anchored object on the page manually

Resize an anchored object

Release an anchored object

[To the top](#)

About anchored objects

Anchored objects are items, such as images or text boxes, that are attached—or *anchored*—to specific text. The anchored object travels with the text containing the anchor as the text reflows. Use anchored objects for all objects that you want associated with a particular line or block of text, for example, sidebars and callouts, figures, or icons associated with a specific word.

You can create an anchored object by pasting or placing an object (or frame) into text using the Type tool or by using the Insert Anchored Object command. When you place the object, Adobe InDesign CS4 adds an anchor marker at the insertion point. Anchored objects inherit the rotation and skew attributes of the text frame they're anchored to—even when the object is positioned outside of the text frame. You can select the object and change these attributes.

You can create anchored objects that use any of the following positions:

Inline Aligns the anchored object with the baseline of the insertion point. You can adjust the Y Offset to position the object above or below the baseline. This is the default type of anchored object. In earlier versions of InDesign, these objects were called *inline graphics*.

Above Line Places the anchored object above the line with the following choices of alignment: Left, Center, Right, Towards Spine, Away From Spine, and (Text Alignment). Text Alignment is the alignment applied to the paragraph that holds the anchor marker.

Custom Places the anchored object in the position that you define in the Anchored Object Options dialog box. You can position the object anywhere inside or outside the text frame.

Note: You can use *inline* and *above line* positioned objects with type on a path. (See *Add anchored objects to type on a path*.)

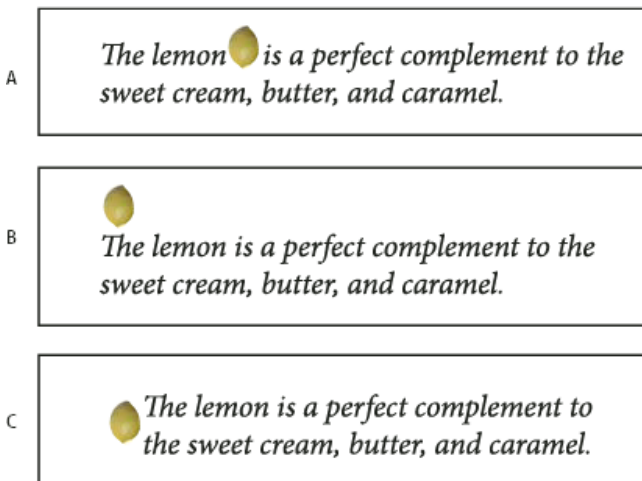

Sample document with anchored objects

A. Inline position B. Above line position (aligned left) C. Custom position (aligned to the edge of the text frame)

For a video tutorial on working with anchored frames, see www.adobe.com/go/vid0073.

Tim Cole provided a shortcut on inserting anchored frames at [Anchored Frames Productivity Shortcut](#).

[To the top](#)

Create an anchored object

If an object isn't available to place into the document (for example, sidebar text that is not written yet), you can create an empty anchored frame as a placeholder for content you can add later. You can resize the anchored frame at any time and the position settings for the frame update automatically.

1. Do one of the following:

- To add an anchored object, use the Type tool to position an insertion point where you want the object's anchor to appear, and then place or paste the object.

 *If the frame for the object is taller than the line of text in which it appears, text might overlap the imported image or you might see increased space above the line. Consider selecting a different anchored object position, inserting a soft or hard line break, resizing the inline object, or specifying a different leading value for the surrounding lines.*

- To anchor an existing object, select it and choose Edit > Cut. Then, using the Type tool, position the insertion point where you want the object to appear, and choose Edit > Paste. By default, the anchored object's position is inline.
- To add a placeholder frame for an object that isn't available (for example, text you have yet to write for a sidebar), use the Type tool to position the insertion point where you want the object's anchor to appear; then choose Object > Anchored Object > Insert.

 *You can anchor text characters by creating outlines of the text. Creating outlines automatically converts each character of text to an inline anchored object.*

2. To position the object, select it with a selection tool and choose Object > Anchored Object > Options. Specify options as desired.

 *To bypass the Anchored Object dialog box, use the Insert Anchored Object/Go To Anchor Marker keyboard shortcut. You'll need to designate keys for this shortcut in the Keyboard Shortcut Editor (it's listed in the Text and Tables area). Pressing the shortcut twice deselects the object and positions the cursor back in the main text. (See Use keyboard shortcut sets.)*

Inserted Anchored Objects options

When you insert a placeholder for an anchored object, you can specify the following options for the contents:

Content Specifies the type of object the placeholder frame will contain.

Note: *If you choose Text, an insertion point appears in the text frame; if you choose Graphic or Unassigned, InDesign selects the object frame.*

Object Style Specifies the style you want to use to format the object. If you have defined and saved object styles, they will appear in this menu.

Paragraph Style Specifies the paragraph style you want to use to format the object. If you have defined and saved paragraph styles, they will appear in this menu.

Note: *If the object style has a paragraph style enabled and you choose a different style from the Paragraph Style menu, or if you make changes to the Anchored Position options for a style, a plus sign (+) appears in the Object Style menu indicating that overrides have been made.*

Height and Width Specify the dimensions of the placeholder frame.

Inline and Above Line position options

When you choose Inline or Above Line from the Position menu in the Anchored Object Options dialog box, the following options are available for setting the position of the anchored object. (You can also access these options in the Insert Anchored Object dialog box.)

Inline Aligns the bottom of the anchored object to the baseline. Inline objects are subject to certain constraints when moving along the *y* axis: the top of the object can't go below the bottom leading slug and the bottom of the object can't go above the top of the leading slug.

Y Offset Adjusts the position on the baseline. You can also use the mouse to drag the object vertically on the page.

Above Line Aligns the object above the text line containing the anchor marker and below the line of text above the anchor marker.

Alignment Choose from the following options:

Left, Right, and Center Align the object within the text column. These options ignore indent values applied to the paragraph and align the object within the entire column.

Towards Spine and Away From Spine Align the object left or right depending on the side of the spread the object is on. These options ignore indent values applied to the paragraph and align the object within the entire column.

(Text Alignment) Aligns the object based on the alignment defined by the paragraph. This option uses the paragraph indent values when aligning the object.

Space Before Specifies the position of the object relative to the bottom of the leading slug in the preceding line of text. Positive values lower both the object and the text below it. Negative values move the text below the object up toward the object. The maximum negative value is the height of the object.

Space After Specifies the position of the object relative to the cap-height of the first character in the line below the object. A value of 0 aligns the bottom of the object to the cap-height position. Positive values move the text below the object down (away from the bottom of the object). Negative values move the text below the object up (toward the object).

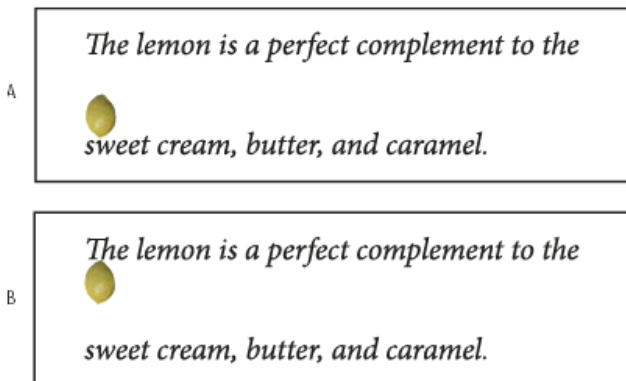

Using the Space Before and Space After options

A. A Space Before value of 0p10 moves the object and its associated text further away from the text line above it. **B.** A Space After value of 0p10 moves the object and the text line above it further away from its associated text line (below).

Note: Anchored objects set to Above Line will always remain with the line that holds the anchor; the text won't compose such that the object is on the bottom of one page and the anchor marker's line is at the top of the next page.

Custom position options

You can use the following options when positioning a custom-positioned anchored object. You can specify these options in the Insert Anchored Object dialog box or the Anchored Object Options dialog box. For step-by-step instructions for using these options, see [Position a custom-](#)

positioned anchored object.

Relative To Spine Specifies whether the object aligns relative to the document spine. When you select this option, the Anchored Object Reference Point proxy displays as a two page spread. The two pages mirror each other. When selected, objects positioned on one side of a spread, for instance the outside margin, remain on the outside margin even when the text reflows to a facing page.

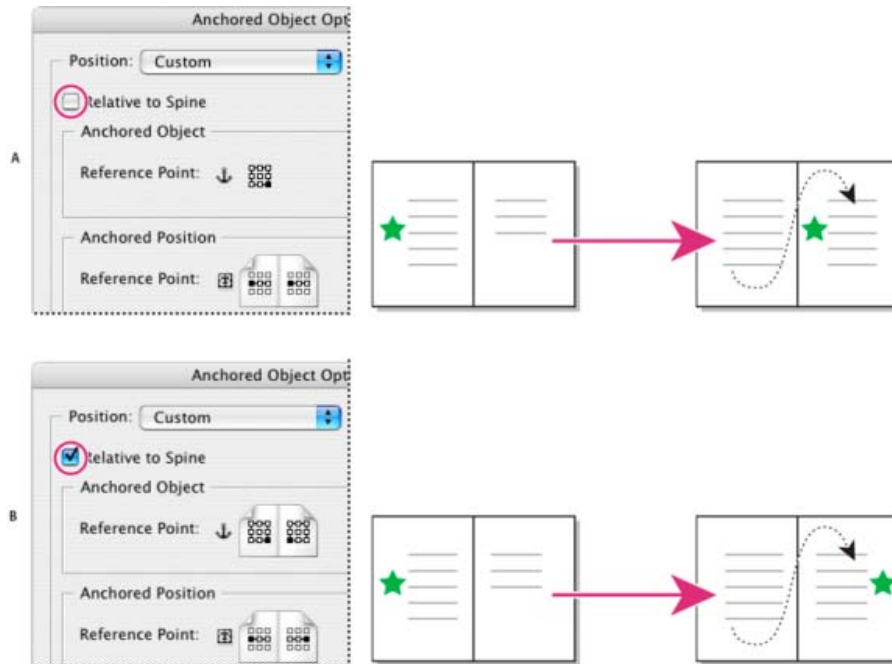

Using the Relative To Spine option

A. Relative To Spine not selected: the object remains on the left side of the text frame when text reflows across to the right side of the spread. **B.** Relative To Spine selected: the object remains on the outside edge of the page when the text reflows to the right side of the spread.

Note: If, after you select Relative To Spine you adjust the X Offset value, the direction the object moves may change. This change occurs because the direction of movement depends partly on the side of the spread the object is on.

Anchored Object Reference Point

Specifies the location on the object that you want to align to the location on the page (as specified by the Anchored Position Reference Point). For example, if you want to align the right side of the object with a page item, such as a text frame, click a rightmost point on this proxy. For more information on using this reference point, see [Position a custom-positioned anchored object](#).

Anchored Position Reference Point

Specifies the location on the page (as defined by the X and Y Relative To options), to which you want to align the object. For example, if you choose Text Frame for X Relative To and Line (Baseline) for Y Relative To, this proxy represents the horizontal area of the text frame and the vertical area of the text line containing the object's anchor marker. If you click the leftmost point on this proxy, the object's reference point  will align with the left edge of the text frame and the baseline of the text.

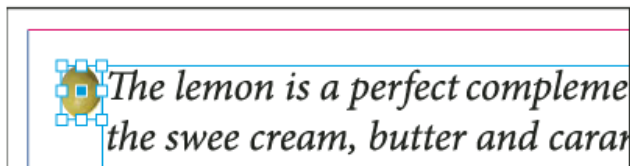

Right side of object aligned with left side of text frame

Note: Depending on what you choose for X Relative To and Y Relative To, the Anchored Position Reference Point proxy displays either three or nine positions. Line options, such as Line (Baseline) provide only three options—middle left, center, and middle right—because the vertical positioning is established by the anchor marker in the text.

X Relative To Specifies what you want to use as the basis for horizontal alignment. For instance, Text Frame lets you align the object to the left, center, or right side of the text frame. Where exactly it aligns horizontally depends on the reference points you choose and any offset you specify for X Offset.

For example, if you want the object to appear in the page margin with its right edge flush with the page margin, choose Page Margin for X Relative To and specify a rightmost point on the Anchored Object Reference Point proxy and a leftmost point for the Anchored Position Reference Point proxy.

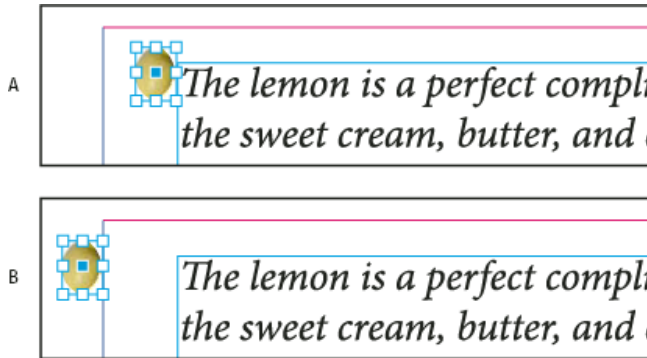

The X Relative To option

A. Aligning the right side of the object to the left side of the text frame **B.** Aligning the right side of the object to the left side of the page margin

X Offset Moves the object left or right. Whether it moves to the left or right depends on the reference point. If aligning to the center of the page item, positive values move the object to the right. The direction of movement also depends on whether you've selected Relative To Spine.

Y Relative To Specifies what the object aligns with vertically. For example, Page Edge lets you use the edge of the page as the basis for aligning the object to the top, center, or bottom of the page. The Anchored Position Reference Point specifies if the object aligns to the top, center, or bottom of this page item. If you choose a line option, such as Line (Baseline), the Anchored Position Reference Point displays only the middle horizontal row of points.

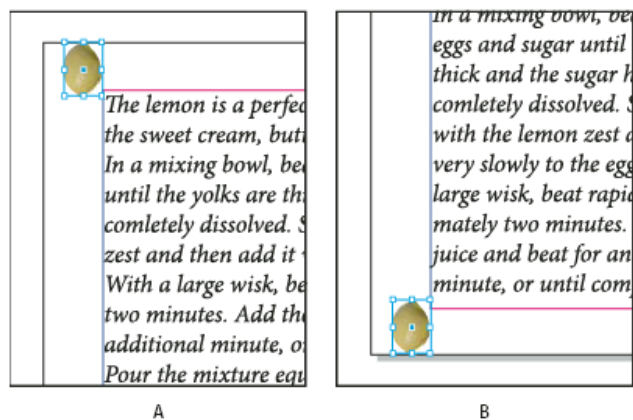

The Y Relative To option

A. Aligning the top of the object to the top page edge **B.** Aligning the bottom of the object to the bottom the page edge

Y Offset Moves the object up or down. Positive values move the object downward.

Keep Within Top/Bottom Column Boundaries Keeps the object inside the text column if reflowing text would otherwise cause it to move outside of the boundaries. In such instances, the bottom of the object will align to the bottom inset, or the top of the object will align to the top inset. For example, an anchored object off to the side of a line of text and in the middle of a column looks fine; however, without this option selected, if the anchored marker flows to the bottom of the column, the object may drop below the column edge or partially off the page. When this option is selected, you can't drag the object above or below the column boundaries. If you resize the object, it will move back into alignment with the top or bottom boundaries of the column, if necessary. This option is only available when you select a line option, such as Line (Baseline) for Y Relative To.

Note: When InDesign overrides the object's position to fall within the bounds of the column, the Y offset value you specify appears in the dialog

box with a plus sign (+).

Prevent Manual Positioning Ensures that you can't move the anchored object by dragging or nudging it on the page.

Preview Displays the position adjustments on the page as you make them.

[To the top](#)

Position a custom-positioned anchored object

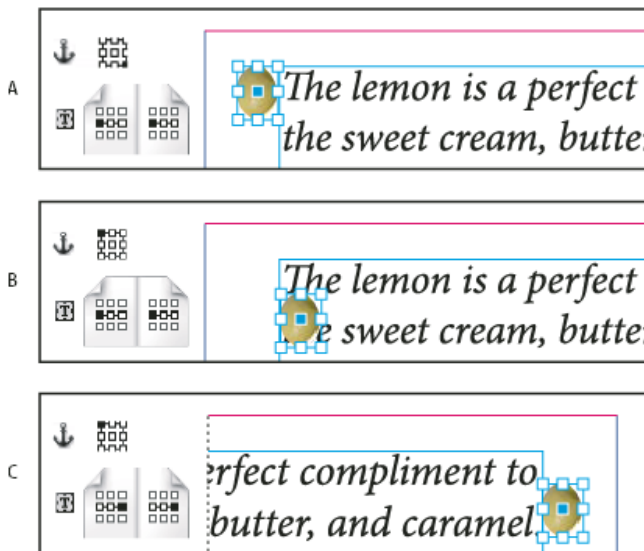

Note the following when using the Anchored Object Options dialog box to position custom-positioned anchored objects.

- The custom position options include four main options: The two Reference Point proxies and the X and Y Relative To menus. These options all work together to specify the object's location. For instance, what you choose for X Relative To and Y Relative To determines what the Anchored Position Reference Point represents—it could be a text frame, a text line within a column, or an entire page. The following image represents how you can change the location of the object by choosing a different reference point while leaving the X and Y Relative To options unchanged.



Changing the location of the anchored object (X Relative To set to Text Frame; Y Relative To set to Line (Baseline))

A. Choosing the lower right point on the Anchored Object proxy and left center point on Anchored Position proxy. **B.** Changing Anchored Object proxy point to upper left corner and leaving the Anchored Position proxy point at center left **C.** Leaving the Anchored Object proxy at top left and changing Anchored Position proxy point to center right

- To create an anchored object that maintains its position on the page (such as the top left corner) as text reflows and moves only when the text reflows to another page, anchor the object to the page margins or page edges. For example, set both X Relative To and Y Relative To to Page Margin, click the top left reference point for the object  and the top left reference point for the page item . As the text reflows, the object remains in the top left corner, within the page margins. Only when the text line containing the anchor flows to another page does the object move—to the top left corner of the next page.

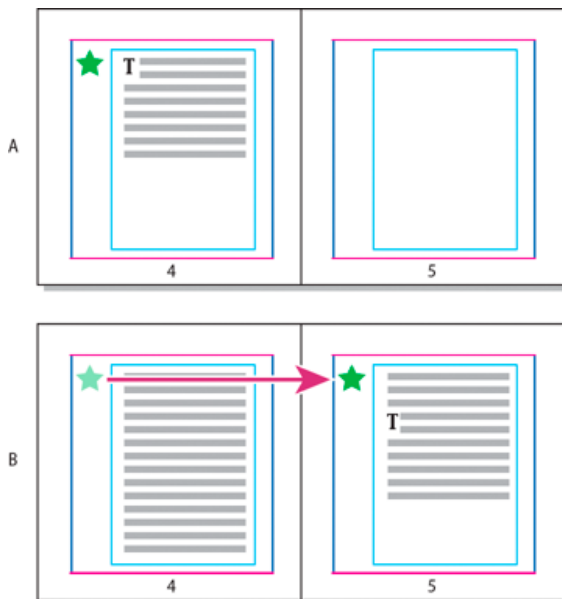

Positioning anchored object to a specific location on the page

A. Position object using use Page Margin or Page Edge for X and Y Relative To **B.** When text reflows, object does not follow text until text moves to another page

- To keep the object aligned with a specific line of text so that the object stays with that text when it reflows, choose a Line option from the Y Relative To menu.
- To keep the object within the text frame, but not with a specific line of text when text reflows, choose Text Frame from the X Relative To menu.
- To align the object relative to the margin (for example, to create a sidebar that stays in the outside margin as the text reflows from page to page), select Relative To Spine.

1. Select the object and choose Object > Anchored Object > Options.

2. From the Position menu, choose Custom.

 To see the object move on the page as you specify options, select Preview at the bottom of the dialog box.

3. To keep the object on the same side of the page, relative to the document spine, select Relative To Spine. For example, select this if you want the object to always appear in the outside margin, no matter what side of the spread it is on.

4. Click the point on the Anchored Object Reference Point proxy  that represents the point on the object that you want to align to the page.

5. From the X Relative To menu, choose the page item that you want to use as the horizontal basis for alignment of the object. For example, choose Text Frame to align the object to left, right, or center of the text frame.

6. From the Y Relative To menu, choose the page item that you want to use as the vertical basis for alignment of the object. For example, if you want the object to align to the baseline of the text to which it's anchored, choose Line (Baseline).

7. Click the point on the Anchored Position Reference Point proxy  that represents where within the page items chosen from the X and Y Relative To menus that you want to align the object.

8. Specify an X Offset or Y Offset to nudge or move the object away from the alignment point.



9. To ensure that the object does not extend below or above a column edge as text reflows, select Keep within Top/Bottom Column Boundaries. This option is only available when you select a line option, such as Line (Baseline), from the Y Relative To menu.

10. Click OK.

[To the top](#)

Working with anchored objects using drag-and-drop (CS5.5)

Working with anchored objects using drag-and-drop (CS5.5)

You can drag an existing object into a text frame to anchor it or move it. Use the Selection tool  or Direct Selection tool  to select the object, and then drag the blue square near the upper-right corner of the text frame. Do one of the following:

- To anchor an existing object, drag the blue square to the position where you want the object's anchor to appear.
- To create an inline object, press Shift and drag the blue square to the position where you want the object to appear.
- To specify anchored object options, press Alt (Windows) or Option (Mac OS) and drag the blue square to the position where you want the object's anchor to appear.

[To the top](#)

Selecting and copying anchored objects

Using the Selection tool, you can select only one anchored object at a time. Using the Type tool, you can select a range of text with multiple anchored object markers. When you select multiple anchor markers with the Type tool, you can change the position options for all the anchored objects at once.



Note: *If you have more than one anchored object in the same position—for example, if one line of type holds the markers for two anchored objects with the same anchoring attributes—the objects will overlap each other.*

When you copy text containing an anchored object marker, you copy the anchored object as well. If you copy an anchored object and paste it outside of text, the anchored object becomes an independent image that is not linked to text.

[To the top](#)

View anchored object markers on the page

To view anchors and their relationship to the text on the page, you can display object markers. Use any of the following methods:

- To view the anchor markers  in the text, choose Type > Show Hidden Characters.
- To view a dashed line from an anchor marker to its associated custom-positioned object, select the object and choose View > Extras > Show Text Threads. The thread extends from the anchor marker to the current proxy point for the anchored object.
- To view anchor symbols  on anchored objects, choose View > Extras > Show Frame Edges. Viewing anchor symbols is helpful when determining which objects are anchored.



[To the top](#)

Reposition an anchored object on the page manually

Moving a frame moves its anchored objects, unless the object is positioned relative to margins or pages.

Note: *Before moving an anchored object, make sure that you deselect the Prevent Manual Positioning option for the object in the Anchored Objects dialog box or choose Object > Unlock Position.*

- Do one of the following:

- To move inline anchored objects, use the Selection tool  or Direct Selection tool  to select the object, and then drag vertically. You can move inline objects vertically only, not horizontally.

 If you want to move an inline or above line object outside of the text frame, convert it to a custom-positioned object and then move it as desired.

- To move inline anchored objects, use the Selection tool or Direct Selection tool to select the object, and then drag vertically in horizontal frame or horizontally in a vertical frame. In horizontal text, you can move inline objects vertically only, not horizontally. In vertical text, you can move inline objects horizontally only.
- To move an inline anchored object parallel to the baseline, place the insertion point before or after the object and specify a new value for kerning.

 If you want to move an inline or above line object outside of the text frame, convert it to a custom-positioned object and then move it as desired.



To move custom-positioned anchored objects, use the Selection tool or Direct Selection tool to select the object, and then drag vertically or horizontally.

 You can also rotate and transform an anchored object. (See *Transform objects and Rotate objects.*)

[To the top](#)

Resize an anchored object

Before resizing an anchored object, make sure that you deselect the Prevent Manual Positioning option in the Annotated Objects Options dialog box.

- Use the Selection tool  or Direct Selection tool  to select the object, and then drag the side or corner handle.

Note: *Vertically resizing inline or above line anchor markers might result in the object becoming overset. If the anchor marker is overset, the object will be overset as well.*

Resizing an anchored object might also reposition the object. For example, if you've aligned the right side of an object to the left side of the text frame, and then you drag the object's right side handle 1 pica to the left (away from the text frame boundary), the object will resize and then move back 1 pica to the right.

[To the top](#)

Release an anchored object

If you no longer want an object to move relative to its associated text, you can release it to remove its anchor.

- Select the anchored object with a selection tool, and choose Object > Annotated Object > Release.

The object's position on the page doesn't move.

Note: *Release doesn't work for inline or above line objects. If you can't use Release, select the anchored object and then cut and paste it. You can also use the Type tool to select and cut the anchored object.*

 Twitter™ and Facebook posts are not covered under the terms of Creative Commons.

[Legal Notices](#) | [Online Privacy Policy](#)

Adding editorial notes in InDesign

- [Add editorial notes](#)
- [Use Notes mode](#)
- [Manage notes](#)
- [Edit Notes preferences](#)

The Notes feature in InDesign uses the workflow user names to identify the author of a note or a tracked change. Notes and tracked changes are color-coded for each user as defined in Notes preferences in InDesign or the User dialog box in InCopy (File > User).

Notes can appear only in text. In InDesign, they can be printed only from the Story Editor, and they cannot be exported to PDF.

[To the top](#)

Add editorial notes

When you add editorial notes to managed content in InDesign, these notes become available to others in the workflow. The notes are primarily intended to be used with an InCopy workflow, but you can take advantage of them in InDesign. For example, you can place text in notes that you might want to put into a story later. In InCopy, when you export to Adobe PDF, notes can be converted to PDF comments.

1. Using the Type tool, click where you want to place the note, and choose Type > Notes > New Note.

When editing in Story Editor, bookends appear. In Layout view, the Notes panel appears.

2. Type your note between the note bookends, or type your note in the Notes panel.

You can add as many notes as you want in any location. However, you cannot create a note within another note.

To show or hide notes, choose View > Extras > Show Notes or Hide Notes.

[To the top](#)

Use Notes mode

Notes Mode is a convenient way to add, split, or delete notes, depending on where the insertion point is located or what text is selected.

1. Do any of the following:

- To create a new note, place the insertion point in text.
- To convert text to a note, select the text.
- To split a note, place the insertion point inside a note.
- To convert the note to text, select the note bookends (in Story Editor).
- To move the insertion point out of a note, place the insertion point at the beginning or end of the note.

2. Choose Type > Notes > Notes Mode.

[To the top](#)

Manage notes

A note anchor ¶ marks the location of a note. The Notes panel displays the contents of the note, along with specific information about the note.

- To convert text to a note, select text and choose Type > Notes > Convert To Note. A new note is created. The selected text is removed from the body of the story and pasted into the new note. The note anchor or bookend is located where the text you selected was cut.
- To convert a note to text, select the text in the Notes panel that you want to add to the text of the document. Or, in Story Editor, select the text in the inline note. Then choose Type > Notes > Convert To Text.
- To split a note, place the insertion point in the note where you want it to be split and choose Type > Notes > Split Note.
- To navigate among notes, click the insertion point in the story and choose Type > Notes > Previous Note or Notes > Next Note.

[To the top](#)

Edit Notes preferences

Preferences settings let you set the color for note anchors, bookends, and backgrounds when inline in the Story Editor. You can also choose to display note info as a tool tip, as well as choose whether to include note content in Find/Change operations and spell checking in the Story Editor.

1. Choose Edit > Preferences > Notes (Windows) or InDesign > Preferences > Notes (Mac OS).
2. Select a color for note anchors and note bookends from the Note Color menu. Select [User Color] to use the color specified in the User dialog box. This is especially useful if more than one person is working on the file.
3. Select Show Note Tool Tips to display note information and some or all of the note content as a tool tip when the mouse pointer hovers over a note anchor in Layout view or a note bookend in Story Editor.
4. Specify whether you want to include inline note content when using the Find/Change and Spell Check commands (in Story Editor only).
Note: *In Layout view, you cannot use the Find/Change and Spell Check commands to search for the contents of notes, regardless of the settings in the Preferences dialog box. However, Change All does edit the contents of notes.*
5. Select either [None] or [Note Color] (the color you chose in step 2) to use for the background color of an inline note.
6. Click OK.

Adobe also recommends

 Twitter™ and Facebook posts are not covered under the terms of Creative Commons.

[Legal Notices](#) | [Online Privacy Policy](#)

Linked stories | CS5.5

- [Create a linked story](#)
- [Specify linked story options](#)
- [Update a linked story](#)
- [Edit original story](#)

Replicating content across various pages is no easy task; copy-pasting is error prone and time consuming. Use linked stories to manage multiple versions of a story or text content in the same document. Linked stories make it easier to support emerging workflows, where for example, you need to design for vertical and horizontal layouts. Linked stories also work well for traditional print and publishing workflows, where you might need to synchronize boilerplate text on different pages.

Linked stories behave similar to traditional links. You can designate a story as the parent, and then place the same story at other places in the document as child stories. Whenever you update the parent story, the child stories are flagged in the Links panel and you can update them to synchronize with the parent story. You can create linked stories using regular stories or text on path stories. Anchored objects inside stories are also supported.

Linked stories remain in sync when you update any applied styles InDesign styles.

Linked stories are flagged as out of sync in the Links panel, even though there are no visible changes. Global changes in the document that causes InDesign to recompose the stories, flags the links. These global changes may be due to updates to options or definitions of the following:

- Footnotes
- Text variables
- Conditional text
- Swatches
- XML Tags
- Named grids

Additionally, if you replace all fonts, or replace all instances of an object, InDesign recomposes all the stories, and flags the links.

[To the top](#)

Create a linked story

1. Select a story by either selecting the text frame or place the insertion cursor in the text. You can also select multiple stories by using Shift+Click if you're selecting text frames.
2. Choose Edit > Place and Link Story. The cursor is loaded with the story.
3. Click in an existing empty text frame or draw a frame to place the linked story.

The  icon displays on the upper-left corner of linked story. The story is displayed as linked story in the Links panel. By default, the name of the story in the Links panel is created using the first few characters of the original story.

 *You can also change the default name of linked story through Layers panel.*

[To the top](#)

Specify linked story options

1. In the Links panel, select the linked story.

2. From the Links panel menu, choose Linked Story Options.

3. Select the options as required:

- Update Link When Saving Document
- Warn if Link Update will Overwrite Local Edits
- Remove Forced Line Breaks

Tip: To specify default story options, with all documents closed, open the links panel menu and choose Linked Story Options.

Tip: To specify Linked Story Options while creating linked stories, press the Shift key when you choose Edit > Place and Link Story.

[To the top](#)

Update a linked story

If an original story is edited, the Links panel displays ⚠ next to the linked story.

- In the Links panel, double-click ⚠ to update the child story.

If you have made local edits to a child story, the edits are overwritten with content from the original story. If you set Warn if Link Update Will Overwrite Local Edits, a warning message displays.

💡 Use the Link Info pane to determine if you've made local edits to the story; story status displays "Text Modified" if you've made local edits.

[To the top](#)

Edit original story

If you're working on a linked story, and need to go to the original story, do the following:

1. In the Links panel, select the linked story.
2. Click  or choose Edit Original from the Links panel menu (☰).

Focus shifts to the page that contains the original story.

 Twitter™ and Facebook posts are not covered under the terms of Creative Commons.

[Legal Notices](#) | [Online Privacy Policy](#)

Styles

[Applying GREP styles \(video 4:46\)](#)

Michael Ninness (Jan. 1, 2011)

video-tutorial

This video tutorial shows you how to apply a character style to any text that matches the GREP expression you specify. Make the GREP style part of a paragraph style.

Drop caps and nested styles

- [Apply a character style to a drop cap](#)
- [Create nested styles](#)
- [Create GREP styles](#)

There are three main ways to use Drop Caps and Nested Styles feature: to apply a character style to a drop cap, to apply a nested style to text at the beginning of a paragraph, and to apply a nested line style to one or more lines in a paragraph.

[To the top](#)

Apply a character style to a drop cap

You can apply a character style to the drop-cap character or characters in a paragraph. For example, if you want a drop-cap character to have a different color and font than the rest of the paragraph, you can define a character style that has these attributes. Then you can either apply the character style directly to a paragraph, or you can nest the character style in a paragraph style.

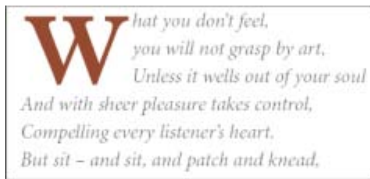

Drop cap formatted automatically by nested character style

1. Create a character style that has the formatting you want to use for the drop-cap character.
2. Do one of the following:
 - To apply the drop cap to a single paragraph, choose Drop Caps And Nested Styles from the Paragraph panel menu.
 - To nest the character style in a paragraph style, double-click the paragraph style, and then click Drop Caps And Nested Styles.
3. Specify the number of drop-cap lines and characters, and then choose the character style.
4. If the drop cap is aligned too far away from the left edge, select Align Left Edge.

Selecting this option uses the original left side bearing of the drop-cap character rather than the larger value. It's particularly useful for drop caps formatted in sans serif fonts.

5. If the drop cap character overlaps the text below it, select Scale For Descenders.
6. Click OK.

If you want to apply a different nested style to any characters after the drop cap, use the New Nested Style option. (See [Create nested styles](#).)

[To the top](#)

Create nested styles

You can specify character-level formatting for one or more ranges of text within a paragraph or line. You can also set up two or more nested styles to work together, one taking over where the previous one ends. For paragraphs with repetitive and predictable formatting, you can even loop back to the first style in the sequence.

Nested styles are especially useful for run-in headings. For example, you can apply one character style to the first letter in a paragraph and another character style that takes effect through the first colon (:). For each nested style, you can define a character that ends the style, such as a tab character or the end of a word.

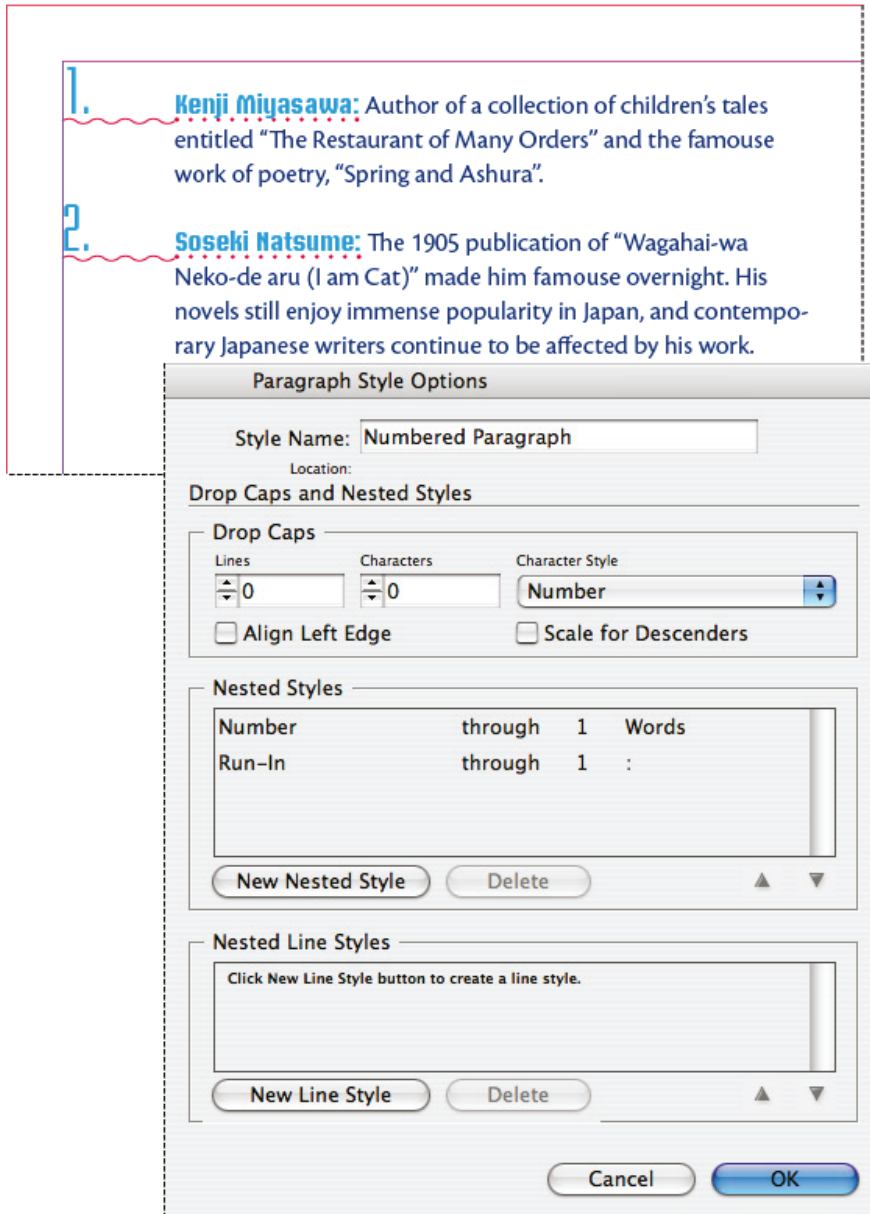

In this example, the Number character style formats the first word, and the Run-in character style formats text through the first colon.

Michael Murphy provides an article on nested styles at [InDesign's Nested Styles Auto-Format Multiple Paragraphs](#). He also provides a series of video tutorials that starts at [Nested Style Sheets](#).

Create one or more nested styles

1. Create one or more character styles that you want to use to format text.

2. Do one of the following:

- To add nested styles to a paragraph style, double-click the paragraph style, and then click Drop Caps And Nested Styles.
- To add nested styles to a single paragraph, choose Drop Caps And Nested Styles from the Paragraph panel menu.

Note: For best results, apply nested styles as part of paragraph styles. If you apply nested styles as local overrides to a paragraph, subsequent editing or formatting changes in the nested style can produce unexpected character formatting in the styled text.

3. Click New Nested Style one or more times.

4. Do any of the following for each style, and then click OK:

- Click the character style area, and then select a character style to determine the appearance of that section of the paragraph. If you haven't created a character style, choose New Character Style and specify the formatting you want to use.
- Specify the item that ends the character style formatting. You can also type the character, such as a colon (:) or a specific letter or number. You cannot type a word.
- Specify how many instances of the selected item (such as characters, words, or sentences) are required.
- Choose Through or Up To. Choosing Through includes the character that ends the nested style, while choosing Up To formats only those characters that precede this character.
- Select a style and click the up button ▲ or down button ▼ to change the order of the styles in the list. The order of the styles determines the sequence in which the formatting is applied. The formatting defined by the second style begins where the formatting of the first style concludes. If you apply a character style to the drop cap, the drop-cap character style acts as the first nested style.

Create nested line styles

You can apply a character style to a specified number of lines in a paragraph. As with nested styles, you can set up two or more nested line styles to work together, and you can create a repeating sequence.

Attributes applied by nested line styles can co-exist with attributes applied by nested styles. For example, a nested line style can apply a color while a nested style can apply italics. If both set conflicting settings of the same attribute, such as red and blue, the nested style takes precedence over the nested line style.

1. Create one or more character styles that you want to use to format text.

2. Do one of the following:

- To add nested line styles to a paragraph style, double-click the paragraph style, and then click Drop Caps And Nested Styles.
- To add nested line styles to a single paragraph, choose Drop Caps And Nested Styles from the Paragraph panel menu.

3. Click New Nested Line Style one or more times.

4. Click the character style area, and then select a character style to determine the appearance of that section. If you haven't created a character style, choose New Character Style and specify the formatting you want to use.

5. Specify the number of paragraph lines you want the character style to affect.

Select a style and click the up button ▲ or down button ▼ to change the order of the styles in the list. The order determines the sequence in which the formatting is applied.

6. Click OK.

Loop through nested styles

You can repeat a series of two or more nested styles throughout a paragraph. A simple example would be to alternate red and green words in a paragraph. Or, in nested line styles you could alternate red and green lines in a paragraph. The repeating pattern remains intact even if you add or remove words in the paragraph.

1. Create the character styles you want to use.
2. Edit or create a paragraph style, or place the insertion point in the paragraph you want to format.
3. In the Drop Caps And Nested Styles section or dialog box, click New Nested Style (or New Nested Line Style) at least twice and choose settings for each style.
4. Do either of the following:
 - For nested styles, click New Nested Style again, choose [Repeat] in the character style area, and specify how many nested styles will be repeated.
 - For nested line styles, click New Nested Line Style again, choose [Repeat] in the character style area, and specify how many lines will be repeated.

In some cases, you may want to skip the first style or styles. For example, an events calendar paragraph may include “This Week’s Events” followed by days of the week and their events. In this case, you could create five nested styles: one for “This Week’s Events,” one each for the day, event, and event time, and a final style with a [Repeat] value of 3, thereby excluding the first nested style from the loop.

The [Repeat] item should be the last in the list. Any nested style below [Repeat] is ignored.

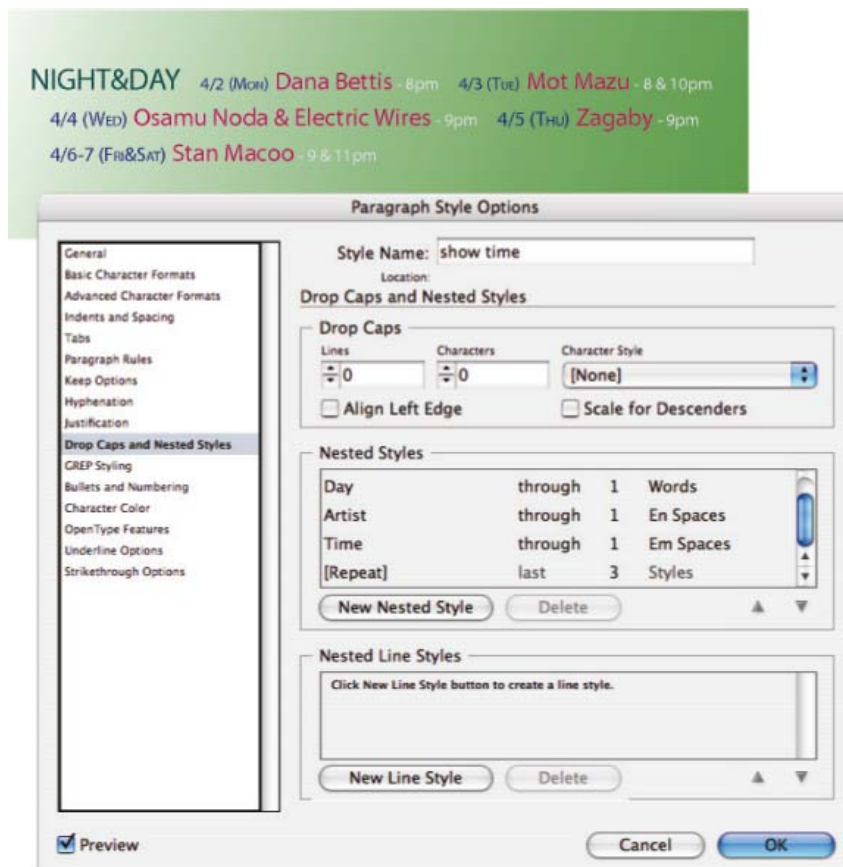

Looping through nested styles

5. Click OK.

Nested style character style options

To determine how a nested character style ends, select any of the following:

 *If you don't want the character to be included in the nested style formatted, choose Up To instead of Through when you define the nested style.*

Sentences Periods, question marks, and exclamation points indicate the end of a sentence. If a quotation mark follows the punctuation, it is included as part of the sentence.

Words Any space or white space character indicates the end of a word.

Characters Any character other than zero-width markers (for anchors, index markers, XML tags and so on) is included.

Note: *If you select Characters, you can also type a character, such as a colon or a period, to end the nested style. If you type multiple characters, any of those characters will end the style. For example, if your run-in headings end with a hyphen, colon, or question mark, you can type -:? to end the nested style where any of these characters appears.*

Letters Any character that does not include punctuation, white space, digits, and symbols.

Digits The Arabic numerals 0–9 are included.

End Nested Style Character Extends the nested style up to or through the appearance of the End Nested Style character you insert. To insert this character, choose Type > Insert Special Character > Other > End Nested Style Here.

Tab Characters Extends the nested style up to or through the tab character (not the tab setting).

Forced Line Break Extends the nested style up to or through the forced line break. (Choose Type > Insert Break Character > Forced Line Break.)

Indent To Here Character Extends the nested style up to or through the Indent To Here character. (Choose Type > Insert Special Character > Other > Indent To Here.)

Em Spaces, En Spaces, or Non-breaking Spaces Extends the nested style up to or through the space character. (Choose Type > Insert White Space > [space character].)

Anchored Object Marker Extends the nested style up to or through an inline graphic marker, which appears where an inline graphic is inserted.

Auto Page Number / Section Marker Extends the nested style up to or through the page number or section name marker.

End a nested style

In most cases, a nested style ends where the condition of the defined style is met, such as after three words or where a period appears. However, you can also end a nested style before the condition is met using the End Nested Style Here character.

1. Place the insertion point where you want the nested style to end.
2. Choose Type > Insert Special Character > Other > End Nested Style Here.

This character ends the nested style at that point, regardless of the nested style definition.

Remove the formatting of a nested style

- In the Drop Caps And Nested Styles dialog box, or in the Drop Caps And Nested Styles section of the Paragraph Style Options dialog box, select the nested style and click Delete.
- Apply a different paragraph style.

[To the top](#)

Create GREP styles

GREP is an advanced, pattern-based search technique. You can use GREP styles to apply a character style to text that conforms to the GREP expression you specify. For example, suppose you want to apply a character style to all the phone numbers in text. When you create a GREP style, you select the character style and specify the GREP expression. All paragraph text that matches the GREP expression is formatted with the character style.

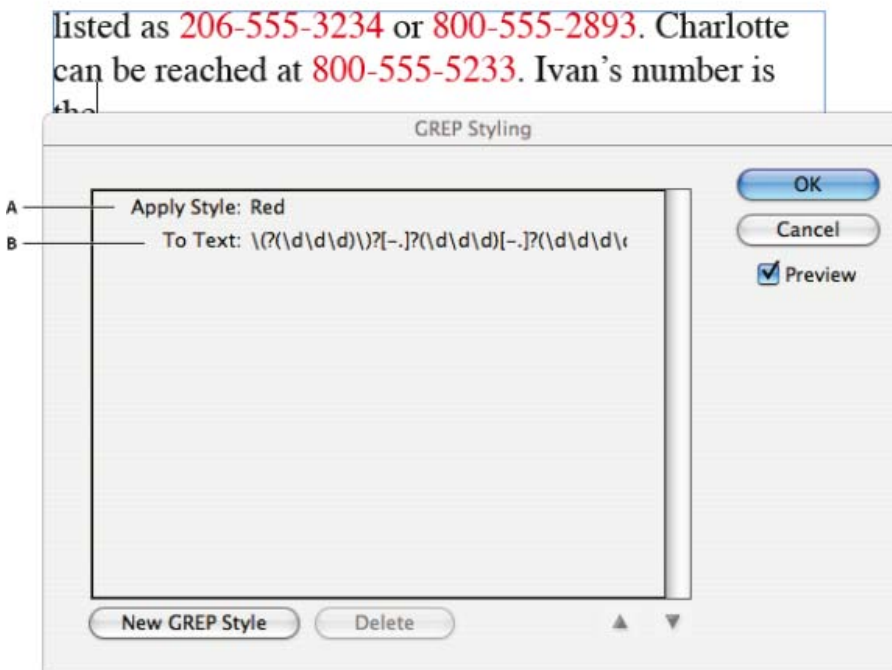

Using GREP style to format phone numbers with a character style

A. Character style **B.** GREP expression

David Blatner provides real-world examples of GREP styles at [5 Cool Things You Can Do with GREP Styles](#). Cari Jansen provides a four-part series about GREP styles that begins at [Introducing GREP Styles](#).

1. Do one of the following:

- To apply GREP styling to individual paragraphs, select the paragraphs and choose Grep Styles from the Paragraph or Control panel menu.
- To use GREP styles in a paragraph style, create or edit a paragraph style, and click the GREP Styling tab on the left side of the Paragraph Style Options dialog box.

2. Click New GREP Style.

3. Click to the right of Apply Style, and then specify a character style. If you haven't created a character style to use, choose New Character Style and specify the formatting you want to use.

4. Click to the right of To Text and do any of the following to construct a GREP expression:
 - Enter the search expression manually. (See Metacharacters for searching.)
 - Click the Special Characters For Search icon to the right of the To Text field. Choose options from the Locations, Repeat, Match, Modifiers, and Posix submenus to help construct the GREP expression.

5. Click OK.

Adobe also recommends

 Twitter™ and Facebook posts are not covered under the terms of Creative Commons.

[Legal Notices](#) | [Online Privacy Policy](#)

Paragraph and character styles

[About character and paragraph styles](#)
[Styles panel overview](#)
[Add paragraph and character styles](#)
[Map styles to export tags | CC, CS6, CS5.5](#)
[Convert Word styles to InDesign styles](#)
[Apply styles](#)
[Edit character and paragraph styles](#)
[Delete character or paragraph styles](#)
[Override character and paragraph styles](#)
[Convert style bullets and numbering to text](#)
[Find and replace character and paragraph styles](#)

[To the top](#)

About character and paragraph styles

A *character style* is a collection of character formatting attributes that can be applied to text in a single step. A *paragraph style* includes both character and paragraph formatting attributes, and can be applied to a paragraph or range of paragraphs. Paragraph styles and character styles are found on separate panels. Paragraph and characters styles are sometimes called *text styles*.

A *named grid* format can be applied to a frame grid in the Frame Grid format settings. (See Named Grids panel overview.) You can also use create an object style with grid characteristics. (See About object styles.)

When you change the formatting of a style, all text to which the style has been applied will be updated with the new format.

You can create, edit, and delete styles in stand-alone Adobe InCopy documents or in InCopy content that is linked to an Adobe InDesign CS4 document. When the contents are updated in InDesign, new styles are added to the InDesign document, but any style modifications made in InCopy will be overridden by the InDesign style. For linked content, it is usually best to manage your styles in InDesign.

[Basic Paragraph] styles

By default, each new document contains a [Basic Paragraph] style that is applied to text you type. You can edit this style, but you can't rename or delete it. You can rename and delete styles that you create. You can also select a different default style to apply to text.

Character style attributes

Unlike paragraph styles, character styles do not include all the formatting attributes of selected text. Instead, when you create a character style, InDesign makes only those attributes that are different from the formatting of the selected text part of the style. That way, you can create a character style that, when applied to text, changes only some attributes, such as the font family and size, ignoring all other character attributes. If you want other attributes to be part of the style, add them when editing the style.

Next Style

You can automatically apply styles as you type text. If, for example, your document's design calls for the style "body text" to follow a heading style named "heading 1," you can set the Next Style option for "heading 1" to "body text." After you've typed a paragraph styled with "heading 1," pressing Enter or Return starts a new paragraph styled with "body text."

If you use the context menu when applying a style to two or more paragraphs, you can cause the parent style to be applied to the first paragraph and the Next Style to be applied to the additional paragraphs. (See [Apply styles](#).)

To use the Next Style feature, choose a style from the Next Style menu when you're creating or editing a style.

Jeff Witchel provides a video tutorial about using the Next Style feature at [Using the Next Style feature](#).

[To the top](#)

Styles panel overview

Use the Character Styles panel to create, name, and apply character styles to text within a paragraph; use the Paragraph Styles panel to create, name, and apply paragraph styles to entire paragraphs. Styles are saved with a document and display in the panel each time you open that document.

When you select text or position the insertion point, any style that has been applied to that text is highlighted in either of the Styles panels, unless the style is in a collapsed style group. If you select a range of text that contains multiple styles, no style is highlighted in the Styles panel. If you select a range of text to which multiple styles are applied, the Styles panel displays "(Mixed)."

Open the Paragraph Styles panel

- Choose Type > Paragraph Styles, or click the Paragraph Styles tab, which appears by default on the right side of the application window.

Open the Character Styles panel

- Choose Type > Character Styles, or click the Character Styles tab on the right side of the application window.

[To the top](#)

Add paragraph and character styles

If the styles you want already exist in another InDesign, InCopy, or word-processing document, you can import those styles for use in your current document. If you are working with a stand-alone story, you can also define character and paragraph styles in InCopy.

Define paragraph or character styles

1. If you want to base a new style on the formatting of existing text, select that text or place the insertion point in it.

If a group is selected in the Styles panel, the new style will be part of that group.

2. Choose New Paragraph Style from the Paragraph Styles panel menu, or choose New Character Style from the Character Styles panel menu.
3. For Style Name, type a name for your new style.
4. For Based On, select which style the current style is based on.

Note: The Based On option lets you link styles to each other, so that changes in one style ripple through the styles that are based on it. By default, new styles are based on [No Paragraph Style] for paragraph styles or [None] for character styles, or on the style of any currently selected text.

5. For Next Style (Paragraph Styles panel only), specify which style is applied after the current style when you press Enter or Return.
6. To add a keyboard shortcut, position the insertion point in the Shortcut box, and make sure Num Lock is turned on. Then hold down any combination of Shift, Alt, and Ctrl (Windows), or Shift, Option, and Command (Mac OS), and press a number on the numeric keypad. You cannot use letters or non-keypad numbers for defining style shortcuts. If your keyboard does not have a Num Lock key, you cannot add

keyboard shortcuts to styles.

7. If you want the new style to be applied to the selected text, select Apply Style To Selection.
8. To specify the formatting attributes, click a category (such as Basic Character Formats) on the left, and specify the attributes you want to add to your style.
 *When specifying a Character Color in the Style Options dialog box, you can create a new color by double-clicking the fill or stroke box.*
9. For character styles, attributes you do not specify are ignored; when the style is applied, text will retain the paragraph style formatting for that attribute. To remove an attribute setting from a character style:
 - From a setting's menu, choose (Ignore).
 - In a text box, delete the option text.
 - In a check box, click until you see a small box (Windows) or a hyphen (-) (Mac OS).
 - For a character color, hold down Ctrl (Windows) or Command (Mac OS) and click the color swatch.
10. When you've finished specifying the formatting attributes, click OK.

Styles you create appear only in the current document. If no document is open, the styles you create will appear in all new documents.

Base one paragraph or character style on another

Many document designs feature hierarchies of styles sharing certain attributes. The headings and subheads, for example, often use the same font. You can easily create links between similar styles by creating a base, or *parent*, style. When you edit the parent style, the *child* styles will change as well. You can then edit the child styles to distinguish them from the parent style.

 *To create a style that's nearly identical to another style, but without the parent-child relationship, use the Duplicate Style command and then edit the copy.*

1. Create a new style.
2. In the New Paragraph Style or New Character Style dialog box, select the parent style in the Based On menu. The new style becomes the child style.

By default, new styles are based on [No Paragraph Style] or [None], or on the style of any currently selected text.

3. Specify formatting in the new style to distinguish it from the style on which it's based. For example, you might want to make the font used in a subheading slightly smaller than the one used in the heading (parent) style.

 *If you make changes to the formatting of a child style and decide you want to start over, click Reset To Base. That restores the child style's formatting to be identical to the style on which it's based. Then you can specify new formatting. Similarly, if you change the Based On style of the child style, the child style definition is updated to match its new parent style.*

Import styles from other documents

You can import paragraph and character styles from another InDesign document (any version) into the active document. During import, you can determine which styles are loaded and what should occur if a loaded style has the same name as a style in the current document. You can also import styles from an InCopy document.

You can import paragraph styles and character styles from an InDesign or InCopy document into a stand-alone InCopy document or InCopy

content that is linked to InDesign. You can determine which styles are loaded, and what should occur if a loaded style has the same name as a style in the current document.

Note: *If you import styles into linked content, new styles are added to the InDesign document when the content is updated, and any style with a name conflict is overridden by the InDesign style with the same name.*

1. In the Character Styles or Paragraph Styles panel, do one of the following:
 - Choose Load Character Styles or Load Paragraph Styles in the Styles panel menu.
 - Choose Load All Text Styles in the Styles panel menu to load both character and paragraph styles.
2. Double-click the InDesign document containing the styles you want to import.
3. In the Load Styles dialog box, make sure that a check mark appears next to the styles you want to import. If any existing style has the same name as one of the imported styles, choose one of the following options under Conflict With Existing Style, and then click OK:

Use Incoming Style Definition Overwrites the existing style with the loaded style and applies its new attributes to all text in the current document that used the old style. The definitions of the incoming and existing styles are displayed at the bottom of the Load Styles dialog box so that you can view a comparison.

Auto-Rename Renames the loaded style. For example, if both documents have a Subheading style, the loaded style is renamed “Subheading copy” in the current document.

You can also use the Books feature to share styles. (See Synchronize book documents.)

[To the top](#)

Map styles to export tags | CC, CS6, CS5.5

Introduction to export tags

Use Export Tagging to define how text with InDesign styles is marked up in HTML, EPUB, or tagged PDF output.

You can also specify CSS class names to add to the exported content. In EPUB/HTML export, CSS classes can be used to differentiate between slight variations in styling. It is not required that you enter a class name - InDesign automatically generates one based on the Style Name.

You cannot preview Export Tagging within the InDesign layout, as it only impacts the exported EPUB, HTML, or PDF file.

Edit All Export Tags lets you efficiently view and modify the mappings in a single dialog box.

Define style-tag mapping

1. For the style to map, open the paragraph, character, or Object Style Options dialog box.
2. Click Export Tagging in the left pane, and do one of the following:
 - Choose a Tag to map for EPUB and HTML output.
 - Specify a Class to map for EPUB and HTML output. Class names are used to generate style definitions for default tags.
 - If you want to include this style in the CSS, select the Emit CSS checkbox. If you don't select the checkbox, no CSS class will be generated for this style. If you have two or more styles having the same class assigned, InDesign displays an error/warning message while exporting. This option is available only in InDesign CC.
 - Choose a Tag to map for PDF output. This option is available only for paragraph styles.

Edit all export tags

You can view and modify all export tags together in a single window.

1. Select Edit All Export Tags in the Paragraph, Character, or Object style panel menu.
2. Click EPUB and HTML, or PDF.
3. Click the tag corresponding to the style. It gets converted to a list; choose the new value.

[To the top](#)

Convert Word styles to InDesign styles

While importing a Microsoft Word document into InDesign or InCopy, you can map each style used in Word to a corresponding style in InDesign or InCopy. By doing so, you specify which styles format the imported text. A disk icon  appears next to each imported Word style until you edit the style in InDesign or InCopy.

1. Do one of the following:
 - To add the Word document to existing text in InDesign or InCopy, choose File > Place. Select Show Import Options, and then double-click the Word document.
 - To open the Word document in a stand-alone InCopy document, start InCopy, choose File > Open, and then double-click the Word file.
2. Select Preserve Styles And Formatting From Text And Tables.
3. Select Customized Style Import, and then click Style Mapping.
4. In the Style Mapping dialog box, select the Word style, and then select an option from the menu under InDesign style. You can choose the following options:
 - If there is no style name conflict, choose New Paragraph Style, New Character Style, or choose an existing InDesign style.
 - If there is a style name conflict, choose Redefine InDesign Style to format the imported style text with the Word style. Choose an existing InDesign style to format the imported style text with the InDesign style. Choose Auto Rename to rename the Word style.
5. Click OK to close the Style Mapping dialog box, and then click OK to import the document.

[To the top](#)

Apply styles

By default, applying a paragraph style won't remove any existing character formatting or character styles applied to part of a paragraph, although you have the option of removing existing formatting when you apply a style. A plus sign (+) appears next to the current paragraph style in the Styles panel if the selected text uses a character or paragraph style and also uses additional formatting that isn't part of the applied style. Such additional formatting is called an *override* or *local* formatting.

Character styles remove or reset character attributes of existing text if those attributes are defined by the style.

Apply a character style

1. Select the characters to which you want to apply the style.
2. Do one of the following:
 - Click the character style name in the Character Styles panel.
 - Select the character style name from the drop-down list in the Control panel.
 - Press the keyboard shortcut you assigned to the style. (Make sure that Num Lock is on.)

Apply a paragraph style

1. Click in a paragraph, or select all or part of the paragraphs to which you want to apply the style.
2. Do one of the following:
 - Click the paragraph style name in the Paragraph Styles panel.
 - Select the paragraph style name from the menu in the Control panel.
 - Press the keyboard shortcut you assigned to the style. (Make sure that Num Lock is on.)
3. If any unwanted formatting remains in the text, choose Clear Overrides from the Paragraph Styles panel.

Apply sequential styles to multiple paragraphs

The Next Style option specifies which style will be automatically applied when you press Enter or Return after applying a particular style. It also lets you apply different styles to multiple paragraphs in a single action.

For example, suppose you have three styles for formatting a newspaper column: Title, Byline, and Body. Title uses Byline for Next Style, Byline uses Body for Next Style, and Body uses [Same Style] for Next Style. If you select an entire article, including the title, the author's byline, and the paragraphs in the article, and then apply the Title style using the special "Next Style" command in the context menu, the article's first paragraph will be formatted with the Title style, the second paragraph will be formatted with the Byline style, and all other paragraphs will be formatted with the Body style.

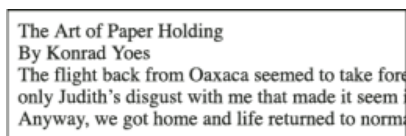

The Art of Paper Holding
By Konrad Yoes
The flight back from Oaxaca seemed to take fore
only Judith's disgust with me that made it seem
Anyway, we got home and life returned to norma

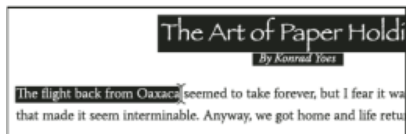

The Art of Paper Holdi
By Konrad Yoes
The flight back from Oaxaca seemed to take forever, but I fear it wa
that made it seem interminable. Anyway, we got home and life retu

Before and after applying a style with Next Style.

1. Select the paragraphs to which you want to apply the styles.
2. In the Paragraph Styles panel, right-click (Windows) or Control-click (Mac OS) the parent style, and then choose *Apply [Style Name] Then Next Style*.

If the text includes formatting overrides or character styles, the context menu also lets you remove overrides, character styles, or both.

Edit character and paragraph styles

One of the advantages of using styles is that when you change the definition of a style, all of the text formatted with that style changes to match the new style definition.

Note: If you edit styles in InCopy content that's linked to an InDesign document, the modifications are overridden when the linked content is updated.

Edit a style using the dialog box

1. Do one of the following:

- If you don't want the style to be applied to selected text, right-click (Windows) or Control-click (Mac OS) the style name in the Styles panel, and choose Edit *[style name]*.
- In the Styles panel, double-click the style name, or select the style and choose Style Options in the Styles panel menu. Note that this applies the style to any selected text or text frame or, if no text or text frame is selected, sets the style as the default style for any text you type in new frames.

2. Adjust settings in the dialog box, and then click OK.

Redefine a style to match selected text

After you apply a style, you can override any of its settings. If you decide you like the changes you made, you can redefine the style so that it matches the formatting of the text you changed.

Note: If you redefine styles in InCopy content linked to an InDesign document, the modifications are overridden when the linked content is updated.

1. Using the Type tool , select the text formatted with the style you want to redefine.
2. Make changes to the paragraph or character attributes as necessary.
3. Choose Redefine Style in the Styles panel menu.

Delete character or paragraph styles

When you delete a style, you can select a different style to replace it, and you can choose whether to preserve the formatting. When you delete a style group, you delete all styles within the group. You are prompted to replace each style in the group one at a time.

1. Select the style name in the Styles panel.
2. Do one of the following:
 - Choose Delete Style in the panel menu or click the Delete icon  at the bottom of the panel.
 - Right-click (Windows) or Control-click (Mac OS) the style, and then choose Delete Style. This method is especially useful for deleting a style without applying it to text.

3. In the Delete Paragraph Style dialog box, select the style to replace it.

If you select [No Paragraph Style] to replace a paragraph style or [None] to replace a character style, select Preserve Formatting to keep the formatting of text to which the style is applied. The text preserves its formatting but is no longer associated with a style.

4. Click OK.

 To delete all unused styles, choose *Select All Unused* in the Styles panel menu, and then click the Delete icon. When you delete an unused style, you are not prompted to replace the style.

[To the top](#)

Override character and paragraph styles

When you apply a paragraph style, character styles and other previous formatting remain intact. After you apply a style, you can override any of its settings by applying formatting that's not part of the style. When formatting that is not part of a style is applied to text with that style applied, it is called an *override* or *local* formatting. When you select text with an override, a plus sign (+) appears next to the style name. In character styles, an override is displayed only if the applied attribute is part of the style. For example, if a character style only changes text color, applying a different font size to the text does not appear as an override.

You can clear character styles and formatting overrides when you apply a style. You can also clear overrides from a paragraph to which a style has been applied.

 If a style has a plus sign (+) next to it, hold the mouse pointer over the style to view a description of the override attributes.

Preserve or remove overrides when applying paragraph styles

- To apply a paragraph style and preserve character styles, but remove overrides, hold down Alt (Windows) or Option (Mac OS) as you click the name of the style in the Paragraph Styles panel.
- To apply a paragraph style and remove both character styles and overrides, hold down Alt+Shift (Windows) or Option+Shift (Mac OS) as you click the name of the style in the Paragraph Styles panel.

 Right-click (Windows) or Control-click (Mac OS) the style in the Paragraph Styles panel, and then choose an option from the context menu. You can then clear overrides, character styles, or both while applying the style.

Clear paragraph style overrides

1. Select the text containing the overrides. You can even select multiple paragraphs with different styles.

2. In the Paragraph Styles panel, do any of the following:

- To remove paragraph and character formatting, click the Clear Overrides icon , or choose Clear Overrides from the Paragraph Styles panel.
- To remove character overrides, but preserve paragraph formatting overrides, hold down Ctrl (Windows) or Command (Mac OS) as you click the Clear Overrides icon.
- To remove paragraph-level overrides, but preserve character-level overrides, in the Paragraph Styles panel, hold down Shift+Ctrl (Windows) or Shift+Command (Mac OS) as you click the Clear Overrides icon.

Note: When you clear overrides, paragraph-level overrides are removed from the entire paragraph, even if only part of the paragraph is selected. Character-level overrides are removed only from the selection.

Clearing overrides does not remove character style formatting. To remove character style formatting, select the text containing the character style, and then click [None] in the Character Styles panel.

Break the link between text and its style

When you break the link between text and its style, the text retains its current formatting. However, future changes to that style will not be reflected in the text that was separated from the style.

1. Select the text that is marked with the style that you want to break from.
2. Choose Break Link To Style from the Styles panel menu.

If no text is selected when you choose Break Link To Style, any new text you type uses the same formatting as the selected style, but no style is assigned to that text.

[To the top](#)

Convert style bullets and numbering to text

When you create a style that adds bullets or numbering to paragraphs, these bullets and numbers may be lost if the text is copied or exported to a different application. To avoid this problem, convert the style bullets or numbering to text.

Note: *If you convert style bullets in an InCopy story linked to an InDesign layout, the change may be overridden when the content is updated in InDesign.*

1. In the Paragraph Styles panel, select the style that contains the bullets and numbering.
2. In the Paragraph Styles panel menu, choose Convert “[style]” Bullets and Numbering to Text.

If you convert bullets and numbering to text in a style on which another style is based (a *parent* style), the bullets and numbering in the child style are also converted to text.

After you convert numbering to text, you may need to update numbers manually if you edit the text.

[To the top](#)

Find and replace character and paragraph styles

Use the Find/Change dialog box to find instances of a particular style and replace it with another.

1. Choose Edit > Find/Change.
2. For Search, select Document to change the style throughout the document.
3. Leave the Find What and Change To options blank. If the Find Format and Change Format boxes don't appear at the bottom of the dialog box, click More Options.
4. Click the Find Format box to display the Find Format Settings dialog box. Under Style Options, select the character or paragraph style you want to search for, and then click OK.
5. Click the Change Format box to display the Change Format Settings dialog box. Under Style Options, select the replacement character or paragraph style, and then click OK.
6. Click Find, and then use the Change, Change/Find, or Change All buttons to replace the style.

Adobe also recommends



Twitter™ and Facebook posts are not covered under the terms of Creative Commons.

[Legal Notices](#) | [Online Privacy Policy](#)

Object styles

- [About object styles](#)
- [Object Styles panel overview](#)
- [Define object styles](#)
- [Apply object styles](#)
- [Use default object styles](#)
- [Clear object style overrides](#)
- [Break the link to an object style](#)
- [Rename an object style](#)
- [Edit object styles](#)
- [Delete an object style](#)
- [Redefine an object style](#)
- [Import object styles](#)

[To the top](#)

About object styles

Just as you use paragraph and character styles to quickly format text, you can use *object styles* to quickly format graphics and frames. Object styles include settings for stroke, color, transparency, drop shadows, paragraph styles, text wrap, and more. You can assign different transparency effects for the object, fill, stroke, and text.



You can apply object styles to objects, groups, and frames (including text frames). A style can either clear and replace all object settings or it can replace only specific settings, leaving other settings unchanged. You control which settings the style affects by including or excluding a category of settings in the definition.



You can also apply object styles to frame grids. By default, any frame grid you create uses the [Basic Grid] object style. You can edit the [Basic Grid] style or you can apply other object styles to the grid. When you create or edit an object style for a frame grid, use the Story Options section to specify writing direction, frame type, and named grid.

When creating styles, you might find that several styles share some of the same characteristics. Rather than setting those characteristics each time you define the next style, you can base one object style on another. When you change the base style, any shared attributes that appear in the “parent” style change in the “child” style as well.

[To the top](#)

Object Styles panel overview

Use the Object Styles panel to create, edit, and apply object styles. For each new document, the panel initially lists a default set of object styles. Object styles are saved with a document and display in the panel each time you open that document. The Text Frame icon  marks the default style for text frames; the Graphics Frame icon  marks the default style for graphics frames and drawn shapes.

Use the Object Styles panel to create, name, and apply object styles. For each new document, the panel initially lists a default set of object styles. Object styles are saved with a document and display in the panel each time you open that document. The Text Frame icon  marks the default style for text frames; the Graphics Frame icon  marks the default style for graphic frames; the Grid icon  marks the default style for frame grids.

Open the Object Style panel

- Choose Window > Styles > Object Styles.

Change how object styles are listed in the panel

- Select Small Panel Rows from the panel menu to display a more condensed version of the object styles.
- Drag the object style to a different position. When a black line appears in the desired position, release the mouse button.
- Select Sort By Name from the panel menu to list the object styles in alphabetical order.

[To the top](#)

Define object styles

You can define a style based on the settings you've already applied to an object, or you can create a style from scratch or based on another style.

1. Select the object or text frame that uses the settings you want the object style to include.
2. Choose New Object Style from the Object Styles panel menu, or Alt-click (Windows) or Option-click (Mac OS) the Create New Style button.
3. In the New Object Style dialog box, type a name for the style.
4. To base the style on another style, choose a style for Based On.

Note: The Based On option lets you link styles to each other, so that changes in one style ripple through the styles that are based on it. If you make changes to the formatting of a child style and decide you want to start over, click Reset To Base. That restores the child style's formatting to be identical to the style on which it's based.

5. To add a keyboard shortcut, position the insertion point in the Shortcut box, and make sure Num Lock is turned on. Then hold down any combination of Shift, Alt, and Ctrl (Windows) or Shift, Option, and Command (Mac OS), and press a number on the numeric keypad. You cannot use letters or non-keypad numbers for defining style shortcuts.
6. Under Basic Attributes, select any additional categories that contain options you want to define, and set the options as desired. Click the check box to the left of each category to indicate whether it should be included or ignored in the style.

Use the Story Options category to specify the writing direction, frame type, and named grid of a grid object style. The named grid stores frame grid settings that can be applied to any frame grid.

7. To apply effects, choose an option in Effects For (Object, Stroke, Fill, or Text), and then select categories of effects and specify their settings. You can specify different effects for each category. Indicate which Effects categories should be turned on, turned off, or ignored in the style.
8. Under Export Options, select an option and specify export parameters for the option. You can define Alt text for placed images and graphics. For tagged PDFs, you can apply tags and actual text settings. For HTML and EPUB layouts, you can specify different conversion settings on each object so that they render well on different screen sizes and pixel densities.

Note: Object export options are used to specify export parameters required when you export to different formats such as EPUB, HTML, or accessible PDFs. Object export options are applied to both text frames and graphic frames, as well as groups. See Object export options.

9. Click OK.

Object style categories

If you want the style to apply only certain attributes, leaving any other settings untouched, make sure that the categories you want the style to control are in the appropriate state. You can use any of three states for each category: turned on, turned off, or ignored. For example, checking the Drop Shadow box will include drop shadow formatting in the object style. Deselecting the Drop Shadow box will indicate that drop shadow is turned off as part of the style — any drop shadow applied to an object appears as an override. Setting the Drop Shadow box to "ignore" (a small

box in Windows or a hyphen in Mac OS) will leave drop shadow out of the style, so any drop shadow applied to the style does not appear as an override.

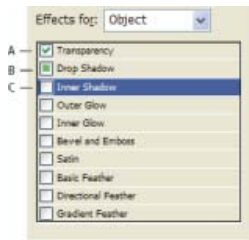

Object style categories

A. Turned on **B.** Ignored **C.** Turned off

Note: Categories in which the settings can be turned on or off individually, such as Fill, Stroke, and Transparency, have only two states. They can either be turned on or ignored.

The Paragraph Styles category is ignored by default, even if you're creating a text frame. This category is applicable only if the object is an unthreaded text frame.

[To the top](#)

Apply object styles

If you apply an object style to a group of objects, the object style is applied to each object in the group. To apply an object style to a group of objects, nest the objects within a frame. (The Edit > Paste Into command is one way to paste an object into a frame.)

1. Select an object, frame, or group.
2. Click an object style in the Control panel or the Object Styles panel to apply a style.

If you choose Clear Overrides When Applying Style from the Object Styles panel, clicking an object style clears overrides by default. If this option is not selected, you can Alt-click (Windows) or Option-click (Mac OS) the object style to clear overrides while applying the style.

 You can also drag an object style onto an object to apply the style without first selecting the object.

If a group is selected when you apply an object style, the style is applied to each object in the group.

Once you apply a style, you can apply other settings to the object as needed. Although you may override a setting defined in the style, you do not lose the connection to the style.

[To the top](#)

Use default object styles

For each new document, the Object Styles panel lists a default set of object styles. Whenever you create an object, an object style is applied to it. By default, if you create a text frame, the [Basic Text Frame] object style is applied. If you draw a path or shape, the [Basic Graphics Frame] object style is applied. If you place an image or draw a placeholder shape that has an X in it, the [None] object style is applied. You can select a different object style to use as the default for text frames and graphics frames.

For each new document, the Object Styles panel lists a default set of object styles. Whenever you create an object, an object style is applied to it. By default, if you create a text frame, the [Basic Text Frame] object style is applied. If you place an image or draw a path or shape, the [Basic Graphics Frame] object style is applied. If you create a frame grid, the [Basic Grid] object style is applied. If you draw a placeholder shape that has an X in it, the [None] object style is applied. You can select a different object style to use as the default for each of these object types.

- To change the default style for a text frame, choose Default Text Frame Style from the Object Styles panel menu, and then select the object

style.

- To change the default style for a graphics frame, choose Default Graphics Frame Style from the Object Styles panel menu, and then select the object style.
- Graphic placeholder frames (with an X in them), always use the [None] style as default. You cannot specify an object style as default.
- To change the default style for a grid frame, choose Default Grid Style from the Object Styles panel menu, and then select the object style.
- To change the default style for any object type, drag the icon that marks the default object type from one object style to another.

Note: If you select an object style when no frame is selected, that object style becomes the new default object style for text or graphics, depending on which tool is selected in the toolbox.

Note: If you select an object style when no frame is selected, that object style becomes the new default object style for text, graphics, or grid frames, depending on which tool is selected in the toolbox.

You can edit the [Basic] styles, but you cannot delete them.

[To the top](#)

Clear object style overrides

When formatting is applied to an object that differs from part of the style definition applied to that object, it is called an *override*. When you select an object with an override, a plus sign (+) appears next to the style name.

Use the Clear Overrides command to override any formatting that is either turned on or off in the object style; use the Clear Attributes Not Defined By Style to clear ignored attributes.

Clear object style overrides

1. Select an object or group that you want to change.
2. In the Object Styles panel, click the Clear Overrides button  at the bottom of the Object Styles panel.

An override is displayed only if the applied attribute is part of the style.

Clear attributes ignored in an object style

You may want to remove attributes from an object, even if those attributes are ignored in a style. For example, if the Fill category is ignored in an object style and you apply a red fill to a frame to which the object style is applied, choosing Clear Attributes Not Defined By Style removes the red fill.

Note: If an object style category is turned off (unchecked) rather than ignored, use the Clear Overrides command to override the style.

1. Select an object or group that you want to change.
2. In the Object Styles panel, click the Clear Attributes Not Defined By Style button  at the bottom of the Object Styles panel.

[To the top](#)

Break the link to an object style

You can break the link between an object and the style applied to it. The object will retain the same attributes, but will no longer change if the style is changed.

1. Select the object that has the object style applied to it.

2. Choose Break Link To Style from the Object Styles panel menu.

If you don't want to retain the formatting of the object style, choose [None] in the Object Styles panel.

[To the top](#)

Rename an object style

1. Make sure no objects are currently selected so that a style isn't mistakenly applied.
2. In the Object Styles panel, double-click the object style you want to rename.
3. In the Object Style Options dialog box, type a new name for the style, and click OK.



You can also edit an object style directly in the panel. Click the style, pause, and then click again to edit the style name.

[To the top](#)

Edit object styles

1. Do one of the following:
 - If you don't want the style to be applied to the selected frame or set as the default, right-click (Windows) or Control-click (Mac OS) the style name in the Object Styles panel, and choose Edit *[style name]*.
 - In the Object Styles panel, double-click the style name, or select the style and choose Style Options in the Styles panel menu. Note that this applies the style to any selected object or sets it as the default object type.
2. In the Object Style Options dialog box, select the category that contains the options you want to change, and change the desired settings.
3. Determine whether object style categories are turned on, turned off, or ignored.
4. Click OK.

[To the top](#)

Delete an object style

1. In the Object Styles panel, select an object style.
2. Choose Delete Style from the panel menu or drag the style to the Delete icon at the bottom of the Object Styles panel.
3. If you delete a style that is applied to objects or on which other styles are based, you will be prompted to specify a replacement style in the Delete Object Style dialog box. Do one of the following:
 - To restyle objects that currently use the deleted style, choose the style you want to apply to the objects and click OK.
 - To leave objects unchanged, choose [None], make sure Preserve Formatting is checked, and click OK. Any objects that use the deleted style retain the same attributes, but are no longer associated with a style.
 - To remove all attribute settings you've applied, choose [None], deselect Preserve Formatting, and click OK.

Note: *To delete all styles not applied to objects, choose Select All Unused from the Object Styles panel menu, and then click the Delete icon.*

[To the top](#)

Redefine an object style

After you apply an object style, you can override any of its settings. If you decide you like the changes you made to a particular object, you can redefine the style so that it matches the formatting of the object you changed. Be aware that the Redefine Object Style command redefines only categories that are turned on or turned off, but not categories that are ignored. If the object includes additional settings, you'll need to add those settings separately to the style, or simply create a new object style.

1. Select an object that is using the style you want to change.
2. Adjust the desired appearance attributes.
3. In the Object Styles panel, choose Redefine Style from the Object Styles panel menu.

The object style definition changes to match the override settings you applied. All occurrences of the object style in the document are updated to use the new settings.

Note: *If the Redefine Object Style option is not available, the attributes you set are not part of the object style definition. To change the style definition directly, choose Object Style Options instead, or create a new style from the object.*

[To the top](#)

Import object styles

You can import styles from other documents. In addition to object styles themselves, InDesign imports any swatches, custom strokes, character styles, or paragraph styles that are used in the styles. If a swatch, stroke, or paragraph style that you import has the same name but different values than an existing swatch or style, InDesign renames it.

If the object styles you import include named grids, these grids are also imported.

1. Select Load Object Styles from the Object Styles panel menu.
2. Select the file from which you want to import object styles, and click Open.
3. In the Load Styles dialog box, make sure that a check mark appears next to the styles you want to import. If there is a style name conflict, choose one of the following options under Conflict With Existing Style, and then click OK:

Use Incoming Style Definition Overwrites the existing style with the loaded style and applies its new attributes to all objects in the current document that used the old style. The definitions of the incoming and existing styles are displayed at the bottom of the Load Styles dialog box so that you can view a comparison.

Auto-Rename Renames the loaded style.

The object styles appear in the Object Styles panel.

Adobe also recommends

 Twitter™ and Facebook posts are not covered under the terms of Creative Commons.

[Legal Notices](#) | [Online Privacy Policy](#)

Working with styles

Duplicate styles or style groups

Group styles

Move and reorder styles

[To the top](#)

Duplicate styles or style groups

- Right-click (Windows) or Control-click (Mac OS) a style or style group in the Styles panel, and then choose Duplicate Style.

A new style or group appears in the Styles panel, with the same name followed by “copy.” If you duplicated a group of styles, the style names within the new group remain the same.

You can also duplicate styles by copying them to another group.

[To the top](#)

Group styles

You can organize styles by grouping them into separate folders in the Character Styles, Paragraph Styles, Object Styles, Table Styles, and Cell Styles panels. You can even nest groups within groups. Styles do not need to be in a group; you can add them to a group or to the root level of the panel.

Create a style group

1. In the Styles panel:
 - To create the group at the root level, deselect all styles.
 - To create a group within a group, select and open a group.
 - To include existing styles in the group, select the styles.
2. Choose New Style Group from the Styles panel menu, or choose New Group From Styles to move the selected styles into the new group.
3. Type the name of the group and click OK.
4. To move a style into the group, drag the style over the style group. When the style group is highlighted, release the mouse button.

Copy styles to a group

When you copy a style to a different group, the styles are not linked. Even though they have the same name, editing one style does not change the attributes of the other style.

1. Select the style or group you want to copy.

2. Choose Copy To Group from the Styles panel menu.
3. Select the group (or [Root] level) that you want to copy the styles or group to, and then click OK.

If the group already contains style names identical to those being copied, incoming styles are renamed.

Expand or collapse style groups

- To expand or collapse only one group, click the triangle icon next to it.
- To expand or collapse the group and all its subgroups, Ctrl-click (Windows) or Command-click (Mac OS) the triangle icon.

Delete style groups

Deleting a style group deletes the group and everything inside it, including styles and other groups.

1. Select the group you want to delete.
2. Choose Delete Style Group from the Styles panel menu, and then click Yes.
3. For each style in the group, specify a replacement style or choose [None], and then click OK.

 *If you want to use the same replacement style for all styles, select Apply To All.*

If you cancel the replacement of any style, the group is not deleted. You can recover deleted styles by choosing Edit > Undo Delete Styles.

[To the top](#)

Move and reorder styles

By default, styles you create appear at the bottom of the style group or panel.

- To alphabetize all groups and styles within groups, choose Sort By Name from the Styles panel menu.
- To move a single style, drag it to a new location. A black line indicates where the style will be moved to; a highlighted group folder indicates that the style will be added to that group.

 Twitter™ and Facebook posts are not covered under the terms of Creative Commons.

[Legal Notices](#) | [Online Privacy Policy](#)

Typography

[Document installed fonts \(video 2:29\)](#)

Michael Ninness (Jan. 1, 2011)

video-tutorial

Learn how to use document installed fonts in your designs, in InDesign CS5 and later.

Using fonts

- [About fonts](#)
- [Installing fonts](#)
- [Apply a font to text](#)
- [Specify a typeface size](#)
- [Previewing fonts](#)
- [OpenType fonts](#)
- [Installing OpenType fonts](#)
- [Apply OpenType font attributes](#)
- [Work with missing fonts](#)
- [Document installed fonts](#)
- [Multiple master fonts](#)

[To the top](#)

About fonts

A *font* is a complete set of characters—letters, numbers, and symbols—that share a common weight, width, and style, such as 10-pt Adobe Garamond Bold.

Typefaces (often called *type families* or *font families*) are collections of fonts that share an overall appearance, and are designed to be used together, such as Adobe Garamond.

A *type style* is a variant version of an individual font in a font family. Typically, the *Roman* or *Plain* (the actual name varies from family to family) member of a font family is the base font, which may include type styles such as regular, bold, semibold, italic, and bold italic.

[To the top](#)

Installing fonts

When you install InDesign or Adobe Creative Suite, fonts are automatically installed in the system fonts folder.

- Windows: On Windows the fonts are located in the “\Windows\Fonts” folder. For example, c:\Windows\Fonts\
- Mac OS: On Mac, the fonts are located in the “/Library/Fonts”

For information on installing and activating fonts to be used in all applications, see your system documentation or your font manager documentation.

You can make fonts available in InDesign by copying the font files into the Fonts folder inside the InDesign application folder on your hard drive. However, fonts in this Fonts folder are available only to InDesign.

If two or more fonts are active in InDesign and use the same family name but have different Adobe PostScript names, the fonts are available in InDesign. Duplicate fonts are listed in the menus with their font technologies abbreviated in parentheses. For example, a Helvetica TrueType font appears as “Helvetica (TT),” a Helvetica PostScript Type 1 font appears as “Helvetica (T1),” and a Helvetica OpenType font appears as “Helvetica (OTF).” If two fonts have the same PostScript name and one includes .dfont in its name, the other font is used.

Font Installation Instructions

Learn how to install fonts on your computer. Instructions available for most versions of Windows and Mac OS.... [Read More](#)

<http://goo.gl/FvwZF>



by **Adobe Fonts**

<http://www.adobe.com/type>

[Contribute your expertise to Adobe Community Help](#)



[To the top](#)

Apply a font to text

When you specify a font, you can select the font family and its type style independently. When you change from one font family to another, InDesign attempts to match the current style with the style available in the new font family. For example, Arial Bold would change to Times Bold when you change from Arial to Times.

When you apply a bold or italic style to type, InDesign applies the typeface style specified by the font. In most cases, the specific version of bold or italic is applied as expected. However, some fonts may apply a bold or italic variation that isn't exactly labeled bold or italic, respectively. For example, some font designers specify that when you apply bold to a font, the semibold variation is applied.

1. Select the text you want to change.
2. Do any of the following:
 - In the Character panel or Control panel, select a font in the Font Family menu or a style in the Type Style menu. (In Mac OS, you can select type styles in the Font Family submenus.)
 - In the Character panel or Control panel, click in front of the font family name or type style name (or double-click its first word) and type in the first few characters of the name you want. As you type, InDesign displays font family or type style names that match the characters you've typed.
 - Choose a font in the Type > Font menu. Note that you choose both a font family and a type style when you use this menu.

[To the top](#)

Specify a typeface size

By default, typeface size is measured in *points* (a point equals 1/72 of an inch). You can specify any typeface size from 0.1 to 1296 points, in 0.001-point increments.

Note: *In Fireworks, the typeface size is measured in pixels by default.*

1. Select the characters or type objects you want to change. If you don't select any text, the typeface size applies to new text you create.
2. Do one of the following:
 - In the Character panel or Control bar set the Font Size option.
 - Choose a size from the Type > Size menu. Choosing Other lets you type a new size in the Character panel.

 You can change the unit of measurement for type in the Preferences dialog box. This option is not available in Fireworks.

[To the top](#)

Previewing fonts

You can view samples of a font in the font family and font style menus in the Character panel and other areas in the application from where you

can choose fonts. The following icons are used to indicate different kinds of fonts:

- OpenType 
- Type 1 
- TrueType 
- Multiple Master 
- Composite 

You can turn off the preview feature or change the point size of the font names or font samples in Type preferences.

[To the top](#)

OpenType fonts

OpenType fonts use a single font file for both Windows® and Macintosh® computers, so you can move files from one platform to another without worrying about font substitution and other problems that cause text to reflow. They may include a number of features, such as swashes and discretionary ligatures, that aren't available in current PostScript and TrueType fonts.

 *OpenType fonts display the icon.*

When working with an OpenType font, you can automatically substitute alternate glyphs, such as ligatures, small capitals, fractions, and old style proportional figures, in your text.

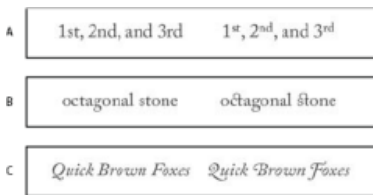

Regular (left) and OpenType (right) fonts
A. Ordinals **B.** Discretionary ligatures **C.** Swashes

OpenType fonts may include an expanded character set and layout features to provide richer linguistic support and advanced typographic control. OpenType fonts from Adobe that include support for central European (CE) languages include the word “Pro,” as part of the font name in application font menus. OpenType fonts that don't contain central European language support are labeled “Standard,” and have an “Std” suffix. All OpenType fonts can also be installed and used alongside PostScript Type 1 and TrueType fonts.

For more information on OpenType fonts, see www.adobe.com/go/opentype.

[To the top](#)

Installing OpenType fonts

InDesign includes fonts from various OpenType families, including Adobe Garamond Pro, Adobe Caslon Pro, Trajan Pro, Caslisch Script Pro, Myriad Pro, Lithos, and Adobe Jenson Pro.

OpenType fonts are installed automatically when you install InDesign or Adobe Creative Suite 4. For information on installing and using OpenType fonts, see www.adobe.com/go/opentype.

[To the top](#)

Apply OpenType font attributes

Use the Character panel or Control panel to apply OpenType font attributes, such as fractions and swashes to text.

For more information on OpenType fonts, see www.adobe.com/go/opentype.

Apply OpenType font attributes

1. Select text.
2. In the Character panel or Control panel, make sure that an OpenType font is selected.
3. Choose OpenType from the Character panel menu, and then select an OpenType attribute, such as Discretionary Ligatures or Fractions.

Features not supported in the current font appear in square brackets, such as [Swash].

 You can also select OpenType font attributes when defining a paragraph or character style. Use the OpenType Features section of the Style Options dialog box.

OpenType font attributes

When you use an OpenType font, you can select specific OpenType features from the Control panel or Character panel menu when formatting text or when defining styles.

Note: OpenType fonts vary greatly in the number of type styles and kinds of features they offer. If an OpenType feature is unavailable, it's surrounded in square brackets (such as [Swash]) in the Control panel menu.

Discretionary Ligatures Font designers may include optional ligatures that shouldn't be turned on in all circumstances. Selecting this option allows these additional optional ligatures to be used, if they are present. For more information on ligatures, see Apply ligatures to letter pairs.

Fractions Numbers separated by a slash (such as 1/2) are converted to a fraction character, when fractions are available.

Ordinal Ordinal numbers such as 1st and 2nd are formatted with superscript letters (1st and 2nd) when ordinals are available. Letters such as the superscript *a* and *o* in the Spanish words *segunda* (2^a) and *segundo* (2^o) are also typeset properly.

Swash When available, regular and contextual swashes, which may include alternate caps and end-of-word alternatives, are provided.

Titling Alternatives When available, characters used for uppercase titles are activated. In some fonts, selecting this option for text formatted in both uppercase and lowercase letters can yield undesired effects.

Contextual Alternatives When available, contextual ligatures and connecting alternates are activated. Alternate characters are included in some script typefaces to provide better joining behavior. For example, the letter pair “bl” in the word “bloom” can be joined so that it looks more like handwriting. This option is selected by default.

All Small Caps For fonts that include real small caps, selecting this option turns characters into small caps. For more information, see Change the case of type.

Slashed Zero Selecting this options displays the number 0 with a diagonal slash through it. In some fonts (especially condensed fonts), it can be difficult to distinguish between the number 0 and the capital letter O.

Stylistic Sets Some OpenType fonts include alternate glyph sets designed for esthetic effect. A *stylistic set* is a group of glyph alternates that can be applied one character at a time or to a range of text. If you select a different stylistic set, the glyphs defined in the set are used instead of the font's default glyphs. If a glyph character in a stylistic set is used in conjunction with another OpenType setting, the glyph from the individual setting overrides the character set glyph. You can see the glyphs for each set using the Glyphs panel.

Positional Forms In some cursive scripts and in languages such as Arabic, what a character looks like can depend on its position inside a word.

The character may change form when it appears at the start (initial position), middle (medial position), or end (final position) of a word, and it may change form as well when it appears alone (isolated position). Select a character and choose a Positional Forms option to format it correctly. The General Form option inserts the common character; the Automatic Form option inserts a form of the character according to where the character is located in the word and whether the character appears in isolation.

Superscript/Superior & Subscript/Inferior Some OpenType fonts include raised or lowered glyphs that are sized correctly relative to the surrounding characters. If an OpenType font doesn't include these glyphs for non-standard fractions, consider using the Numerator and Denominator attributes.

Numerator & Denominator Some OpenType fonts convert only basic fractions (such as 1/2 or 1/4) to fraction glyphs, not non-standard fractions (such as 4/13 or 99/100). Apply Numerator and Denominator attributes to these non-standard fractions in such cases.

Tabular Lining Same widths are provided for full-height figures. This option is appropriate in situations where numbers need to line up from one line to the next, as in tables.

Proportional Oldstyle Varying-height figures with varying widths are provided. This option is recommended for a classic, sophisticated look in text that doesn't use all caps.

Proportional Lining Full-height figures with varying widths are provided. This option is recommended for text that uses all caps.

Tabular Oldstyle Varying-height figures with fixed, equal widths are provided. This option is recommended when you want the classic appearance of old-style figures, but you need them to align in columns, as in an annual report.

Default Figure Style Figure glyphs use the default figure style of the current font.

[To the top](#)

Work with missing fonts

When you open or place documents that include fonts not installed on your system, an alert message appears, indicating which fonts are missing. If you select text that uses a missing font, the Character panel or Control panel indicates that this font is missing by displaying it in brackets in the font style pop-up menu.

InDesign substitutes missing fonts with an available font. When this happens, you can select the text and apply any other available font. Missing fonts for which others have been substituted will appear at the top of the Type > Font menu in a section marked "Missing Fonts." By default, text formatted with missing fonts appears in pink highlighting.

If a TrueType font is installed and the document contains a Type 1 (T1) version of the same font, the font is displayed as missing.

You can choose Type > Find Font to find and change missing fonts. If a missing font is part of a style, you can update the font in that style by changing its style definition.

Make missing fonts available

- Do any of the following:
 - Install the missing fonts on your system.
 - Place the missing fonts in the Fonts folder, which is located in the InDesign application folder. Fonts in this folder are available only to InDesign. See [Installing fonts](#).
 - Activate the missing fonts using a font-management application.

 *If you don't have access to the missing fonts, use the Find Font command to search for and replace missing fonts.*

Highlight substituted fonts in your document

If the Select Substituted Fonts preferences option is selected, text formatted with missing fonts appears in pink highlighting so that you can easily identify text formatted with a missing font.

1. Choose Edit > Preferences > Composition (Windows®) or InDesign > Preferences > Composition (Mac OS®).
2. Select Substituted Fonts, and then click OK.

[To the top](#)

Document installed fonts

Fonts in a Document Fonts folder that is in the same location as an InDesign document are temporarily installed when the document is opened. The Package command can generate a Document Fonts folder when you want to share your document or move it to a different computer.

Fonts in the Document Fonts folder are not the same as fonts available from the standard operating system font locations. They are installed when the document is opened and supersede any font of the same PostScript name. However, they supersede only fonts within the document. Fonts installed by one document are not available to other documents. When you close the document, the fonts that were installed for the document are uninstalled. Document installed fonts are listed in a submenu of the Font menu.

Some Type1 fonts are not available in the document. In addition, Mac OS fonts are not available when running InDesign in Windows.

For a video on using document installed fonts, see <http://tv.adobe.com/go/4955/>.

[To the top](#)

Multiple master fonts

Multiple master fonts are customizable Type 1 fonts whose typeface characteristics are described in terms of variable design axes, such as weight, width, style, and optical size.

Some multiple master fonts include an optical size axis, which lets you use a font specifically designed for optimal readability at a particular size. Generally, the optical size for a smaller font, such as 10 point, is designed with heavier serifs and stems, wider characters, less contrast between thick and thin lines, taller x height, and looser spacing between letters than the optical size for a larger font, such as 72 point.

1. Choose Edit > Preferences > Type (Windows) or InDesign > Preferences > Type (Mac OS).
2. Select Automatically Use Correct Optical Size, and click OK.

Adobe also recommends

 Twitter™ and Facebook posts are not covered under the terms of Creative Commons.

[Legal Notices](#) | [Online Privacy Policy](#)

Aligning text

- [Align or justify text](#)
- [Align paragraphs to a baseline grid](#)
- [Create balanced headline text](#)
- [Create paragraphs that span or split columns](#)
- [Align or justify text vertically within a text frame](#)

[To the top](#)

Align or justify text

Text can be aligned with one or both edges (or *insets*) of a text frame. Text is said to be *justified* when it is aligned with both edges. You can choose to justify all text in a paragraph excluding the last line (Justify Left or Justify Right), or you can justify text in a paragraph including the last line (Justify All). When you have only a few characters on the last line, you may want to use a special end-of-story character and create a flush space.



Justify Left (left) and Justify All (right)

Note: When you justify all lines of text and you are using the Adobe Paragraph Composer, InDesign shifts text to ensure that the paragraph has consistent text density and is visually appealing. You can fine-tune spacing in justified text.

When you set center or justify for text in a frame grid, the text will no longer align exactly with the grid. You can also specify paragraph alignment for all the paragraphs in the frame grid.

1. Select text.
2. Click one of the Alignment buttons (Align Left, Align Center, Align Right, Left Justify, Center Justify, Right Justify and Full Justify) in the Paragraph panel or Control panel.
3. (Optional) Click Align Towards Spine or Align Away From Spine.

When you apply Align Towards Spine to a paragraph, text on a left-hand page is right-aligned, but when the same text flows onto (or if the frame is moved to) a right-hand page, it becomes left aligned. Similarly, when you apply Align Away From Spine to a paragraph, text on a left-hand page is left aligned, while text on a right-hand page is right aligned.

In vertical frames, aligning to or away from the spine has no effect, since text alignment is parallel to the spine direction.

 If you want the left side of a line of text to be left-aligned and the right side to be right-aligned, position the insertion point where you want to right-align the text, press **Tab**, and then right-align the rest of the line.

[To the top](#)

Align paragraphs to a baseline grid

The baseline grid represents the leading for body text in a document. You can use multiples of this leading value for all elements of the page to ensure that text always lines up between columns and from page to page. For example, if the body text in your document has 12-point leading, you could give your heading text 18-point leading and add 6 points of space before the paragraphs that follow the headings.

Using a baseline grid ensures consistency in the location of text elements on a page. You can adjust the leading for the paragraph to ensure that its baselines align to the page's underlying grid. This is useful if you want the baselines of text in multiple columns or adjacent text frames to align. Change settings for the baseline grid by using the Grids section of the Preferences dialog box.

You can also align only the first line of a paragraph to the baseline grid, allowing the rest of the lines to follow the specified leading values.

To view the baseline grid, choose View > Grids & Guides > Show Baseline Grid.

Note: The baseline grid is visible only if the document zoom level is greater than the view threshold setting in Grids Preferences. You may need to zoom in to view the baseline grid.

Align paragraphs to the baseline grid

1. Select text.
2. In the Paragraph panel or Control panel, click Align To Baseline Grid .

 To ensure that the leading of your text does not change, set the baseline grid leading to the same leading value as your text, or to a factor thereof.

Align only the first line to the baseline grid

1. Select the paragraphs you want to align.
2. Choose Only Align First Line To Grid from the Paragraph menu or Control panel menu.
3. In the Paragraph panel or Control panel, click Align To Baseline Grid .

[To the top](#)

Create balanced headline text

You can balance ragged aligned text across multiple lines. This feature is especially useful for multiline headings, pull-quotes, and centered paragraphs.

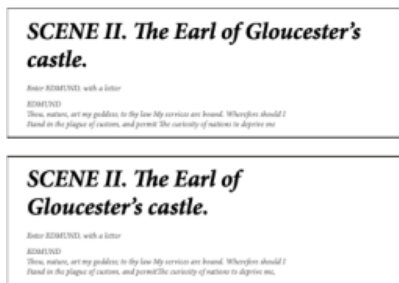

Before and after applying Balance Ragged Lines to the title

1. Click in the paragraph you want to balance.

2. In the Paragraph panel or Control panel, choose Balance Ragged Lines from the menu.

This feature takes effect only when the Adobe Paragraph Composer is selected.

[To the top](#)

Create paragraphs that span or split columns

You can make a paragraph span across multiple columns in a text frame to create a straddle head effect. You can choose whether a paragraph spans all columns or a specified number of columns. When a paragraph is set to span across columns in a multicolumn text frame, any text before the spanning paragraph becomes balanced as a result.

You can also split a paragraph into multiple columns within the same text frame.



Paragraph spanning and splitting multiple columns
A. Heading that spans columns B. Split column

Span a paragraph across columns

1. Place the insertion point inside the paragraph.
You can also make this feature part of a paragraph style, such as a heading style.
2. Choose Span Columns from the Control panel menu or a Paragraph panel menu.
3. Choose Span Columns from the Paragraph Layout menu.
4. Choose the number of columns you want the paragraph to span from the Span menu. Choose All if you want the paragraph to span across all the columns.
5. To add extra space before or after the span paragraph, specify Space Before Span and Space After Span values, and then click OK.

Split a paragraph into columns

1. Place the insertion point inside the paragraph.
You can also make this feature part of a paragraph style, such as a heading style.
2. Choose Span Columns from the Control panel menu or a Paragraph panel menu.

3. Choose Split Columns from the Paragraph Layout menu.

4. Specify the following options, and then click OK:

Sub-columns Choose the number of columns you want the split the paragraph into.

Space Before Split / Space After Split Add space before or after the split paragraph.

Inside Gutter Determine the space between the split paragraphs.

Outside Gutter Determine the space between the outside of the split paragraphs and the margins.

[To the top](#)

Align or justify text vertically within a text frame

You can align or distribute lines of text in a frame along its vertical axis to help keep type vertically consistent among frames and their columns.

You can align text to the top, center, or bottom of the frame using each paragraph's leading and paragraph spacing values. You can also justify text vertically, which evenly spaces lines regardless of their leading and paragraph spacing values.

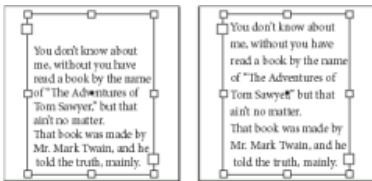

Vertical justification—Bottom (left) and Justify (right)

Vertical text alignment and justification is calculated from the baseline positions of each line of text in the frame. Keep the following in mind as you adjust vertical alignment:

- The top of the frame is defined as the baseline of the first line of top-aligned text. The First Baseline Offset option in the Text Frame Options dialog box affects this value.
- The bottom of the frame is defined as the baseline of the last line of bottom-aligned text. Footnote text is not justified.
- When the Align to Baseline Grid option is applied to paragraphs with Top, Center, or Bottom alignment, all lines will be aligned to the baseline grid. With the Justified option, only the first and last lines will be aligned to the baseline grid.
- If you adjust a text frame's Top or Bottom Inset values in the Text Frame Options dialog box, you change the location of the first or last baseline, respectively.

1. Do one of the following:

- With the Selection tool, select a text frame.
- With the Type tool **T**, click in a text frame.

2. Choose Object > Text Frame Options.

3. In the Vertical Justification section of the Text Frame Options dialog box, choose one of the following options in the Align menu:

- To vertically align text down from the top of the frame, choose Top. (This is the default setting.)
- To center lines of text in the frame, choose Center.
- To vertically align lines of text up from the bottom of the frame, choose Bottom.
- To evenly distribute lines of text vertically between the top and bottom of the frame, choose Justify.

4. If you choose Justify and you want to prevent the leading value from becoming disproportionately larger than the paragraph spacing value, specify a Paragraph Spacing Limit value. The space between paragraphs is expanded up to the value you specify; if the text still doesn't fill the frame, the space between lines is adjusted until the frame is filled. The paragraph spacing limit value is applied in addition to the Space Before or Space After values entered on the Paragraph panel.

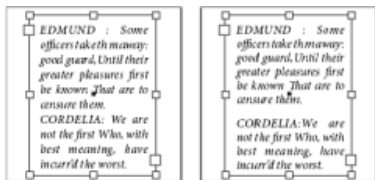

Paragraph spacing limit set to zero (left) and 1 pica (right)

Note: Be careful about vertically justifying multi-column text frames. If the last column contains only a few lines, too much white space may appear between the lines.

5. Click OK.

 An easy way to adjust the Paragraph Spacing Limit value is to select Preview, and then click the up or down arrow next to the Paragraph Spacing Limit value until paragraph spacing appears to be balanced with leading.

Adobe also recommends

 Twitter™ and Facebook posts are not covered under the terms of Creative Commons.

[Legal Notices](#) | [Online Privacy Policy](#)

Formatting paragraphs

[Adjust paragraph spacing](#)

[Use drop caps](#)

[Add rules \(lines\) above or below paragraphs](#)

[Ways to control paragraph breaks](#)



[Control paragraph breaks using Keep Options](#)

[Create hanging punctuation](#)

[To the top](#)

Adjust paragraph spacing

You can control the amount of space between paragraphs. If a paragraph begins at the top of a column or frame, InDesign does not honor the Space Before value. In such a case, you can increase the leading of the first line of the paragraph or increase the top inset of the text frame in InDesign.

1. Select text.
2. In the Paragraph panel or the Control panel, adjust the appropriate values for Space Before  and Space After .

 *To ensure formatting consistency, change paragraph spacing in the paragraph styles you define.*

[To the top](#)

Use drop caps



You can add drop caps to one or more paragraphs at a time. The drop cap's baseline sits one or more lines below the baseline of the first line of a paragraph.

You can also create a character style that can be applied to the drop-cap characters. For example, you can create a tall cap (also called a *raised cap*) by specifying a 1-line, 1-character drop cap and applying a character style that increases the size of the first letter.





One-character, three-line drop cap (left), and five-character, two-line drop cap (right)

Create a drop cap

1. With the Type tool  selected, click in the paragraph where you want the drop cap to appear.
2. In the Paragraph panel or Control panel, type a number for Drop Cap Number Of Lines  to indicate the number of lines you want the drop

cap to occupy.

3. For Drop Cap One Or More Characters , type the number of drop cap characters you want.
4. To apply a character style to the drop cap character, choose Drop Caps And Nested Styles from the Paragraph panel menu, and then choose the character style you created.

 You can also use the Drop Caps And Nested Styles dialog box to align the drop cap to the text edge, reducing the amount of space on the left side of the drop cap, and adjust for drop cap letters with descenders, such as “g” and “y.” If you want to resize, skew, or change the typeface of the drop cap letter for added effect, select the letter or letters and make the formatting changes.

Remove a drop cap

1. With the Type tool  selected, click in the paragraph where the drop cap appears.
2. In the Paragraph panel or Control panel, type 0 for Drop Cap Number Of Lines or Drop Cap Number Of Characters.

[To the top](#)

Add rules (lines) above or below paragraphs

Rules are paragraph attributes that move and are resized along with the paragraph on the page. If you’re using a rule with headings in your document, you may want to make the rule part of a paragraph style definition. The width of the rule is determined by the column width.

The offset for a rule above a paragraph is measured from the baseline of the top line of text to the bottom of the rule. The offset for a rule below a paragraph is measured from the baseline of the last line of text to the top of the rule.

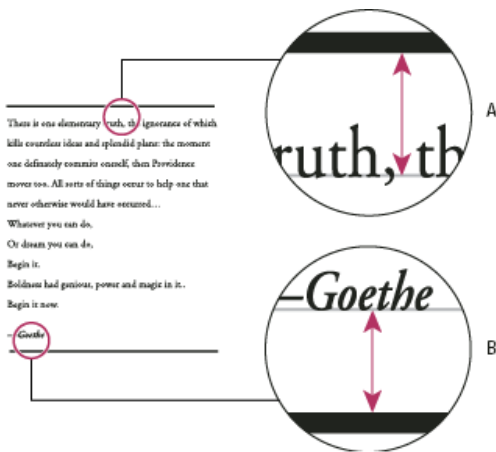

Placement of rules

A. Rule above paragraph **B.** Rule below paragraph

Michael Murphy provides a video tutorial about creating special effects using paragraph rules at [Paragraph Rules Rule](#).

Creative Curio provides an article about creative uses of paragraph rules at [Creative Uses for Paragraph Rules in InDesign, Pt 1](#).

Add a rule above or below a paragraph

1. Select text.
2. Choose Paragraph Rules from the Paragraph panel menu or Control panel menu.

3. At the top of the Paragraph Rule dialog box, select Rule Above or Rule Below.
4. Select Rule On.
Note: *If you want both a rule above and below, make sure that Rule On is selected for both Rule Above and Rule Below.*
5. Select Preview to see what the rule will look like.
6. For Weight, choose a weight or type a value to determine the thickness of the rule. For Rule Above, increasing the weight expands the rule upwards. For Rule Below, increasing the weight expands the rule downward.
7. Select Overprint Stroke when you want to make sure that the stroke doesn't knock out underlying inks on a printing press.
8. Do one or both of the following:
 - Choose a color. The available colors are those listed in the Swatches panel. Select the Text Color option to make the rule the same color as the first character in the paragraph for Rule Above and the last character for Rule Below.
 - Choose a tint or specify a tint value. The tint is based on the color you specified. Note that you can't create tints of the built-in colors None, Paper, Registration, or Text Color.
 - If you specified any line type other than solid, choose a gap color or gap tint to change the appearance of the area between dashes, dots, or lines.
9. Choose the width of the rule. You can choose either Text (from the left edge of text to the line end) or Column (from the left edge of the column to the right edge of the column). If the left edge of the frame has a column inset, the rule begins at the inset.
10. To determine the vertical position of the rule, type a value for Offset.
11. To make sure that the rule above text is drawn within the text frame, select Keep In Frame. If this option isn't selected, the rule can appear outside the text frame.
 *To make sure the paragraph rule at the top of one column aligns with the text at the top of the adjacent column, select Keep In Frame.*
12. Set left or right indents for the rule (not for text) by typing values for Left Indent and Right Indent.
13. Select Overprint Stroke if the paragraph rule will be printed over another color and you want to avoid errors that can occur with printing misregistration. Then click OK.

Remove a paragraph rule

1. Using the Type tool , click in the paragraph containing the paragraph rule.
2. Choose Paragraph Rules from the Paragraph panel menu or Control panel menu.
3. Deselect Rule On and click OK.

[To the top](#)

Ways to control paragraph breaks

You can eliminate orphans and widows, words or single lines of text that become separated from the other lines in a paragraph. *Orphans* fall at the bottom of a column or page, and *widows* fall at the top of a column or page. Another typographic problem to avoid is a heading that stands alone

on a page with the following paragraph on the next page. You have several options for fixing widows, orphans, short exit lines, and other paragraph break problems:

Discretionary hyphens A discretionary hyphen (Type > Insert Special Character > Hyphens And Dashes > Discretionary Hyphen) appears only if the word breaks. This option prevents the common typographic problem of hyphenated words, such as “care-giver,” appearing in the middle of a line after text reflows. Similarly, you can also add a discretionary line break character.

No Break Choose No Break from the Character panel menu to prevent selected text from breaking across a line.

Nonbreaking spaces Insert a nonbreaking space (Type > Insert White Space > *[nonbreaking space]*) between words you want to keep together.

Keep Options Choose Keep Options from the Paragraph panel menu to specify how many lines in the following paragraph remain with the current paragraph.

Start Paragraph Use Start Paragraph in the Keep Options dialog box to force a paragraph (usually a title or heading) to appear at the top of a page, column, or section. This option works especially well as part of a heading paragraph style.

Hyphenation Settings Choose Hyphenation from the Paragraph panel menu to change hyphenation settings.

Edit text Editing text may not be an option depending on the kind of document you work with. If you have license to rewrite, then subtle rewording can often create a better line break.

Use a different composer In general, use Adobe Paragraph Composer to let InDesign compose paragraphs automatically. If a paragraph isn't composed the way you'd like, choose Adobe Single-line Composer from the Paragraph panel menu or Control panel menu and adjust selected lines individually. See Compose text.

[To the top](#)

Control paragraph breaks using Keep Options

You can specify how many lines of the following paragraph remain with the current paragraph as it moves between frames—a convenient way to ensure that headings don't become isolated from the body text they introduce. InDesign can highlight the paragraphs that sometimes break in violation of your settings.

You may not want to use Keep Options if your document does not require your columns to share the same last baseline.

 *To highlight paragraphs that violate Keep Options, choose Edit > Preferences > Composition (Windows) or InDesign > Preferences > Composition (Mac OS), select Keep Violations, and click OK.*

1. Select the paragraph or paragraphs you want to affect.
2. Choose Keep Options in the Paragraph panel menu or Control panel menu. (You can also change keep options when creating or editing a paragraph style.)
3. Choose Keep Options in the Paragraph panel menu. (You can also change keep options when creating or editing a paragraph style.)
4. Select any of these options and then click OK:
 - Select Keep With Previous to keep the first line of the current paragraph with the last line of the previous paragraph.
 - For Keep With Next _ Lines, specify the number of lines (up to five) of the subsequent paragraph that the last line of the current paragraph stays with. This option is especially useful for making sure that a heading stays with the next few lines of the paragraph that follows it.
 - Select the Keep Lines Together option and select All Lines In Paragraph to prevent the paragraph from breaking.
 - Select the Keep Lines Together option, select At Start/End Of Paragraph, and specify the number of lines that must appear at the

beginning or ending of the paragraph to prevent orphans and widows.

- For Start Paragraph, choose an option to force InDesign to push the paragraph to the next column, frame, or page. If Anywhere is selected, the start position is determined by the Keep Line Settings option. For other options, they will be forced to start from these positions.

 When you create paragraph styles for headings, use the Keep Options panel to make sure that your headings remain with the paragraph that follows them.

[To the top](#)

Create hanging punctuation

Punctuation marks and letters such as “W” can make the left or right edges of a column appear to be misaligned. Optical Margin Alignment controls whether punctuation marks (such as periods, commas, quotation marks, and dashes) and edges of letters (such as W and A) hang outside the text margins, so that the type looks aligned.

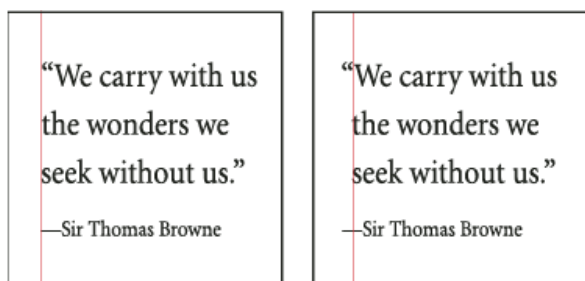

Before (left) and after (right) applying Optical Margin Alignment

1. Select a text frame, or click anywhere in the story.
2. Choose Type > Story.
3. Select Optical Margin Alignment.
4. Select a font size to set the appropriate amount of overhang for the size of type in your story. For optimal results, use the same size as the text.

 To turn off Optical Margin Alignment for an individual paragraph, choose Ignore Optical Margin from the Paragraph panel menu or Control panel menu.

Adobe also recommends

 Twitter™ and Facebook posts are not covered under the terms of Creative Commons.

[Legal Notices](#) | [Online Privacy Policy](#)

Formatting characters

- Apply baseline shift
- Make characters superscript or subscript in a non-OpenType font
- Apply underline or strikethrough
- Apply ligatures to letter pairs
- Change the color, gradient, or stroke of text
- Add transparency effects to text
- Assign a language to text
- Change the case of type
- Scale type
- Skew type

[To the top](#)

Apply baseline shift

Use Baseline Shift to move a selected character up or down relative to the baseline of the surrounding text. This option is especially useful when you're hand-setting fractions or adjusting the position of inline graphics.



Baseline shift values applied to text

1. Select text.
2. In the Character panel or Control panel, type a numeric value for Baseline Shift $\frac{A}{+}$. Positive values move the character's baseline above the baseline of the rest of the line; negative values move it below the baseline.

 *To increase or decrease the value, click in the Baseline Shift box, and then press the Up or Down Arrow key. Hold down Shift while you press the Up or Down Arrow key to change the value in greater increments.*

To change the default increment for baseline shift, specify a value for Baseline Shift in the Units & Increments section of the Preferences dialog box.

[To the top](#)

Make characters superscript or subscript in a non-OpenType font

1. Select text.
2. Choose Superscript or Subscript in the Character panel menu or in the Control panel.

When you choose Superscript or Subscript, a predefined baseline shift value and type size are applied to the selected text.

The values applied are percentages of the current font size and leading, and are based on settings in the Type Preferences dialog box. These values do not appear in the Baseline Shift or Size boxes of the Character panel when you select the text.

Note: *You can change the default size and position of superscripts and subscripts using Advanced Type preferences.*

Apply underline or strikethrough

The default weight of an underline and strikethrough depends on the size of the type.

Jeff Witchel provides a video tutorial about underlining at [Custom Underlines in InDesign](#).

Apply underline or strikethrough

1. Select text.
2. Choose Underline or Strikethrough in the Character panel menu or the Control panel.

Change underline or strikethrough options

Creating custom underlining is especially useful when you want to create an even underline below characters of different sizes, or for creating special effects, such as background highlighting.



Before and after adjusting underlines

1. From the Character panel menu or the Control panel menu, choose Underline Options or Strikethrough Options.
2. Do any of the following, and then click OK:
 - Select Underline On or Strikethrough On to turn on underline or strikethrough for the current text.
 - For Weight, choose a weight or type a value to determine the thickness of the underline or strikethrough line.
 - For Type, select one of the underline or strikethrough options.
 - For Offset, determine the vertical position of the line. The offset is measured from the baseline. Negative values move the underline above the baseline and the strikethrough below the baseline.
 - Select Overprint Stroke when you want to make sure that the stroke doesn't knock out underlying inks on a printing press.
 - Choose a color and tint. If you specified any line type other than solid, choose a gap color or gap tint to change the appearance of the area between dashes, dots, or lines.
 - Select Overprint Stroke or Overprint Gap if the underline or strikethrough will be printed over another color, and you want to avoid errors that can occur with printing misregistration.

 *To change the underline or strikethrough options in a paragraph or character style, use the Underline Options or Strikethrough Options section of the dialog box that appears when you create or edit the style.*

Apply ligatures to letter pairs

InDesign can automatically insert *ligatures*, which are typographic replacement characters for certain letter pairs, such as “fi” and “fl,” when they are available in a given font. The characters that InDesign uses when the Ligature option is selected appear and print as ligatures, but are fully editable, and do not cause the spell checker to flag a word erroneously.



Individual characters (top) and ligature combinations (bottom)

With OpenType fonts, when you choose Ligatures from the Character panel menu or Control panel menu, InDesign produces any standard ligature defined in the font, as determined by the font designer. However, some fonts include more ornate, optional ligatures, which can be produced when you choose the Discretionary Ligatures command.

1. Select text.
2. Choose Ligatures from the Character panel menu or the Control panel menu.

[To the top](#)

Change the color, gradient, or stroke of text

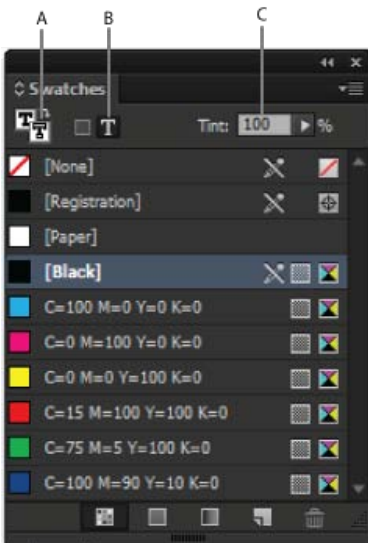

You can apply colors, gradients, and strokes to characters and continue to edit the text. Use the Swatches panel and Stroke panel to apply colors, gradients, and strokes to text, or change Character Color settings when creating or editing a style.





Swatches

A. Swatch affects fill or stroke **B.** Swatch affects container or text **C.** Tint percentage

1. Do one of the following:

- To apply color changes to text inside a frame, use the Type tool  to select text.
 - To apply color changes to all text in a frame, use the Selection tool  to select the frame. When applying color to the text rather than the container, make sure that you select the Formatting Affects Text icon  in the Tools panel or in the Swatches panel.
2. In the Tools panel or in the Swatches panel, select whether you want to apply the color change to the fill or stroke. If you select Stroke, the color change affects only the outline of characters.
3. Do any of the following:
 - In the Swatches panel, click a color or gradient swatch.
 - In the Stroke panel, specify a weight or other stroke options. (See Stroke panel options.)

You can also apply a gradient to text by dragging across the selected text using either the Gradient Swatch tool  or the Gradient Feather tool .

 *To create reverse type, you can change the text fill color to white or [Paper] and the frame's fill color to a dark color. You can also create reverse type by using a paragraph rule behind text; however, if the rule is black, you'll need to change the type to white.*

[To the top](#)

Add transparency effects to text

Use the Effects panel to add transparency effects, such as drop shadows, to text.

Mike Rankin provides examples about transparency effects at [InDesign Eye Candy, Part I](#).

1. Use the Selection tool  to select the text frame.
2. Choose Object > Effects > [effect].
3. Choose Text from the Settings For menu.

You can choose Object if you want the effects you choose to apply to the text frame's stroke and fill as well as the text inside it.

4. Specify the effect attributes and click OK.

If you want to change the text's blending mode or opacity settings, make these changes on the Effects panel.

[To the top](#)

Assign a language to text

Assigning a language to text determines which spelling and hyphenation dictionary is used. Assigning a language does not change the actual text.

1. Do any of the following:
 - To apply the language only to selected text, select the text.
 - To change the default dictionary used in InDesign, choose the language with no documents open.

- To change the default dictionary for a specific document, open the document, choose Edit > Deselect All, and then choose the language.

2. In the Character panel, choose the appropriate dictionary in the Language menu.

InDesign uses Proximity (and WinSoft for some languages) dictionaries for both spelling and hyphenation. These dictionaries let you specify a different language for as little as a single character of text. Each dictionary contains hundreds of thousands of words with standard syllable breaks. Changing the default language does not affect existing text frames or documents.

You can customize language dictionaries to ensure that any unique vocabulary you use is recognized and treated correctly.

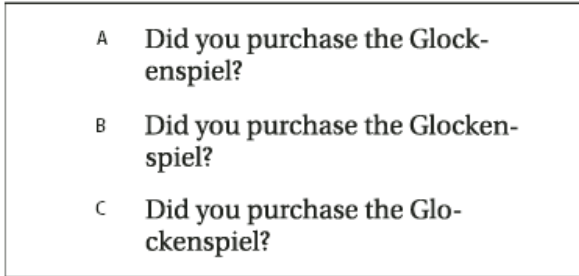

How dictionaries affect hyphenation

A. "Glockenspiel" in English **B.** "Glockenspiel" in Traditional German **C.** "Glockenspiel" in Reformed German

[To the top](#)

Change the case of type

The All Caps or Small Caps commands change the appearance of text, but not the text itself. Conversely, the Change Case command changes the case setting of selected text. This distinction is important when searching or spell-checking text. For example, suppose you type "spiders" in your document and apply All Caps to the word. Using Find/Change (with Case Sensitive selected) to search for "SPIDERS" will not find the instance of "spiders" to which All Caps was applied. To improve search and spell-check results, use the Change Case command rather than All Caps.

Anne-Marie Concepcion provides an article about small caps at [Small Caps vs OpenType All Small Caps](#).

Change text to All Caps or Small Caps

InDesign can automatically change the *case* of selected text. When you format text as small caps, InDesign automatically uses the small-cap characters designed as part of the font, if available. Otherwise, InDesign *synthesizes* the small caps using scaled-down versions of the regular capital letters. The size of synthesized small caps is set in the Type Preferences dialog box.



Before (top) and after (bottom) setting BC and AD in small caps to complement old-style numerals and surrounding text

If you select All Caps or Small Caps in an OpenType font, InDesign creates more elegant type. If you're using an OpenType font, you can also choose All Small Caps from the Character panel menu or the Control panel. (See Apply OpenType font attributes.)

1. Select text.
2. Choose All Caps or Small Caps in the Character panel menu or in the Control panel. If the text was originally typed in all caps, selecting Small Caps will not change the text.

Specify the size for small caps

1. Choose Edit > Preferences > Advanced Type (Windows) or InDesign > Preferences > Advanced Type (Mac OS).
2. For Small Caps, type a percentage of the original font size for text to be formatted as small caps. Then click OK.

Change capitalization

1. Select text.
2. Choose one of the following in the Type > Change Case submenu:
 - To change all characters to lowercase, choose Lowercase.
 - To capitalize the first letter of each word, choose Title Case.
 - To change all characters to uppercase, choose Uppercase.
 - To capitalize the first letter of each sentence, choose Sentence Case.

Note: The Sentence Case command assumes that the period (.), exclamation point (!), and question mark (?) characters mark the ends of sentences. Applying Sentence Case may cause unexpected case changes when these characters are used in other ways, as in abbreviations, file names, or Internet URLs. In addition, proper names may become lowercase when they should be uppercase.

[To the top](#)

Scale type

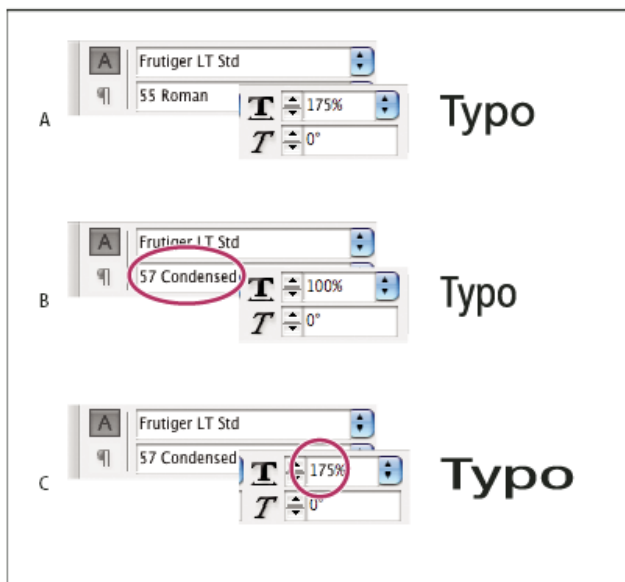

You can specify the proportion between the height and width of the type, relative to the original width and height of the characters. Unscaled characters have a value of 100%. Some type families include a true *expanded font*, which is designed with a larger horizontal spread than the plain type style. *Scaling* distorts the type, so it is generally preferable to use a font that is designed as condensed or expanded, if one is available.



Scaling fonts horizontally

A. Unscaled type **B.** Unscaled type in condensed font **C.** Scaled type in condensed font

Adjust vertical or horizontal scaling

1. Select text you want to scale.
2. In the Character panel or Control panel, type a numeric value to change the percentage of Vertical Scaling  or Horizontal Scaling .

Scale text by resizing the text frame in InDesign

- Do any of the following:
 - Using the Selection tool, hold down Ctrl (Windows) or Command (Mac OS), and then drag a corner of the text frame to resize it.
 - Using the Scale tool , resize the frame.
(See Scale objects.)

Determine the appearance of scaled text values

When you change the scale of a frame, the text inside the frame is also scaled. For example, when you double the size of a text frame, the text also doubles in size; 20-point text increases to 40 points.

David Blatner provides an article about scaled text frames at [Making a Magnifying Glass Text Frame in InDesign](#).

You can change a preferences option to indicate how scaled text appears in panels:

- By default, with Apply To Content selected, the Font Size boxes in the Control panel and Character panel list the new size of text (such as 40 pt). If you select the Adjust Scaling Percentage option, the Font Size boxes display both the original and the scaled size of the text, such as “20 pt (40).”
- The scaling values in the Transform panel tell you the horizontal and vertical percentage by which the frame was scaled. By default, with Apply To Content selected, scaling values display at 100% after a text is scaled. If you select the Adjust Scaling Percentage option, the scaling values reflect the scaled frame, so doubling the scale of a frame displays as 200%.

Tracking scale changes to frames is useful if you have to revert a frame and the text inside it to their original size. It's useful as well for finding out by how much you changed the size of a frame. To track scale changes to frames and the text inside these frames:

1. Choose Edit > Preferences > General (Windows) or InDesign > Preferences > General (Mac OS).
2. Select Adjust Scaling Percentage, and then click OK.

Note the following:

- The Adjust Scaling Percentage preference applies to frames that you scale after the preference is turned on, not to existing frames.
- The Adjust Scaling Percentage preference stays with the text. The scaled point size continues to appear in parentheses even if you turn off the Adjust Scaling Percentage preference and scale the frame again.
- To remove the scaled point size from the Transform panel, choose Redefine Scaling as 100% in the Transform panel. Choosing this option doesn't change the appearance of the scaled frame.

- If you edit the text or scale a frame within threaded frames when the Adjust Scaling Percentage preference is selected, the text is scaled, even if it moves to a different frame. However, if Apply To Content is selected, any text that flows to a different frame as a result of editing is no longer scaled.

[To the top](#)

Skew type

1. Select text.
2. In the Character panel, type a numeric value for Skewing **T**. Positive values slant type to the right; negative values slant type to the left.

Note that applying an angle to type does not produce true italic characters.

Adobe also recommends

- Applying color

 Twitter™ and Facebook posts are not covered under the terms of Creative Commons.

[Legal Notices](#) | [Online Privacy Policy](#)

Text composition

[Compose text](#)
[Hyphenate text](#)
[Prevent unwanted word breaks](#)
[Change Justification settings](#)

[To the top](#)

Compose text

The appearance of text on your page depends on a complex interaction of processes called *composition*. Using the word spacing, letterspacing, glyph scaling, and hyphenation options you've selected, InDesign composes your type in a way that best supports the specified parameters.

InDesign offers two composition methods: Adobe Paragraph Composer (the default) and Adobe Single-line Composer (both are available from the Control panel menu). You can select which composer to use from the Paragraph panel menu, the Justification dialog box, or the Control panel menu.

InDesign supports four methods developed for typesetting, including Adobe Japanese Single-line Composer, Adobe Japanese Paragraph Composer, Adobe Paragraph Composer, and Adobe Single-line Composer. Each Composer evaluates possible breaks for Japanese and Roman text, and chooses those which best support the hyphenation and justification options specified for a given paragraph. The Adobe Japanese Paragraph Composer is selected by the default. For details on these options, see InDesign Help.

InDesign Magazine provides an article about fixing composition problems at [Mind the Gaps](#).

Composition methods

InDesign offers two composition methods: Adobe Paragraph Composer (the default) and Adobe Single-line Composer. Both composition methods evaluate possible breaks, and choose those that best support the hyphenation and justification options you've specified for a given paragraph.

The Adobe Paragraph Composer

Considers a network of breakpoints for an entire paragraph, and thus can optimize earlier lines in the paragraph in order to eliminate especially unattractive breaks later on. Paragraph composition results in more even spacing with fewer hyphens.

The Paragraph Composer approaches composition by identifying possible breakpoints, evaluating them, and assigning a weighted penalty to them based on such principles as evenness of letterspacing, word spacing, and hyphenation.

 You can use the Hyphenation dialog box to determine the relationship between better spacing and fewer hyphens. (See [Hyphenate text](#).)

The Adobe Single-line Composer

Offers a traditional approach to composing text one line at a time. This option is useful if you want to restrict composition changes from late-stage edits.

Choose a composition method for a paragraph

- Do any of the following:

- From the Paragraph panel menu, choose Adobe Paragraph Composer (the default) or Adobe Single-line Composer.
- From the Paragraph panel menu or the Control panel menu, choose Justification, and then choose an option from the Composer menu.

Note: Additional composition engine plug-ins from other companies may be available, along with interfaces that let you customize an engine's parameters.

Set composition preferences

1. Choose Edit > Preferences > Composition (Windows) or InDesign > Preferences > Composition (Mac OS).
2. To use on-screen highlighting to identify compositional problems, select Keep Violations And H&J Violations (hyphenation and justification).
3. To justify text that wraps around an object, select Justify Text Next To An Object.
4. Under Mojikumi Compatibility Modes, determine whether you want to select Use New Vertical Scaling or Use CID-Based Mojikumi.
5. Click OK.

[To the top](#)

Hyphenate text

The settings you choose for hyphenation and justification affect the horizontal spacing of lines and the aesthetic appeal of type on your pages. Hyphenation options determine whether words can be hyphenated and, if they can, which breaks are allowable.

Justification is controlled by the alignment option you choose, the word spacing and letterspacing you specify, and whether or not you have used glyph scaling. You can also justify single words in narrow columns of fully justified text.

Eda Warren provides an article about avoiding composition problems at [Mind the Gaps](#).

Adjust hyphenation manually

You can hyphenate words manually or automatically, or you can use a combination of the two methods. The safest way to hyphenate manually is to insert a *discretionary hyphen*, which is not visible unless the word needs to be broken at the end of a line. Placing a discretionary hyphen at the beginning of a word prevents it from being broken.

1. Using the Type tool **T**, click where you want to insert the hyphen.
2. Do one of the following:
 - Choose Type > Insert Special Character > Hyphens And Dashes > Discretionary Hyphen.
 - Press Ctrl+Shift+- (Windows) or Command+Shift+- (Mac OS) to insert a discretionary hyphen.

Note: Entering a discretionary hyphen in a word does not guarantee that the word will be hyphenated. Whether or not the word breaks depends on other hyphenation and composition settings. However, entering a discretionary hyphen in a word does guarantee that the word can be broken only where the discretionary hyphen appears.

Adjust hyphenation automatically

Hyphenation is based on word lists that can be stored either in a separate user dictionary file on your computer, or in the document itself. To ensure consistent hyphenation, you may want to specify which word list to refer to, especially if you will be taking your document to a service provider or if you work in a workgroup.

- To turn automatic hyphenation on or off for a paragraph, in the Paragraph panel or Control panel, select or deselect the Hyphenation option. (You can also include this option in a paragraph style.)

When you set automatic hyphenation options, you can determine the relationship between better spacing and fewer hyphens. You can also prevent capitalized words and the last word in a paragraph from being hyphenated.

Set automatic hyphenation options for a paragraph

1. Click in a paragraph or select the range of paragraphs you want to affect.
2. Choose Hyphenation from the Paragraph panel menu.
3. Select the Hyphenate option.
4. Make changes to the following settings as needed, and then click OK:

Words With At Least _ Letters Specify the minimum number of characters for hyphenated words.

After First _ Letters / Before Last _ Letters Specify the minimum number of characters at the beginning or end of a word that can be broken by a hyphen. For example, by specifying 3 for these values, *aromatic* would be hyphenated as *aro- matic* instead of *ar- omatic* or *aromat- ic*.

Hyphen Limit _ Hyphens Specify the maximum number of hyphens that can appear on consecutive lines. Zero means unlimited hyphens.

Hyphenation Zone Specify the amount of white space allowed at the end of a line of unjustified text before hyphenation begins. This option applies only when you're using the Single-line Composer with nonjustified text.

Better Spacing / Fewer Hyphens To alter the balance between these settings, adjust the slider at the bottom of the dialog box.

Hyphenate Capitalized Words To prevent capitalized words from being hyphenated, deselect this option.

Hyphenate Last Word To prevent last words in paragraphs from being hyphenated, deselect this option.

Hyphenate Across Column To prevent words from being hyphenated across a column, frame, or page, deselect this option.

[To the top](#)

Prevent unwanted word breaks

By using nonbreaking hyphens, you can prevent certain words from breaking at all—for example, proper names or words which, when broken, become unattractive fragments. By using nonbreaking spaces, you can also keep multiple words from breaking—for example, clusters of initials and a last name (P. T. Barnum).

Prevent text from breaking

1. Select the text you want to keep on the same line.
2. Choose No Break from the Character panel menu or the Control panel menu.

 *Another way to prevent a word from breaking is to place a discretionary hyphen at the beginning of the word. Press Ctrl+Shift+- (Windows) or Command+Shift+- (Mac OS) to insert a discretionary hyphen.*

Create a nonbreaking hyphen

1. Using the Type tool , click where you want to insert the hyphen.
2. Choose Type > Insert Special Character > Hyphens And Dashes > Nonbreaking Hyphen.

Create a nonbreaking space

1. Using the Type tool , click where you want to insert the space.
2. Choose Type > Insert White Space> Nonbreaking Space (or any other white space character).

The Nonbreaking Space varies in width depending on point size, the justification setting, and word space settings, whereas the Nonbreaking Space (Fixed Width) character maintains the same width regardless of context.

[To the top](#)

Change Justification settings

Use the Justification panel to precisely control how word spacing, letterspacing, and glyph scaling. Adjusting spacing is especially useful with justified type, although you can also adjust spacing for unjustified type.

 *Word spacing, character spacing, and glyph scalings for justification settings, are ignored for CJK text. To set CJK text character spacing, use the Mojikumi dialog box.*

Adjust word and letterspacing in justified text

1. Insert the cursor in the paragraph you want to change, or select a type object or frame to change all of its paragraphs.
2. Choose Justification from the Paragraph panel menu.
3. Enter values for Word Spacing, Letter Spacing, and Glyph Spacing. The Minimum and Maximum values define a range of acceptable spacing for justified paragraphs only. The Desired value defines the desired spacing for both justified and unjustified paragraphs:

Word Spacing The space between words that results from pressing the spacebar. Word Spacing values can range from 0% to 1000%; at 100%, no additional space is added between words.

Letter Spacing The distance between letters, including kerning or tracking values. Letter Spacing values can range from -100% to 500%; at 0%, no space is added between letters; at 100%, an entire space width is added between letters.

Glyph Scaling The width of characters (a *glyph* is any font character). Glyph Scaling values can range from 50% to 200%.



 Spacing options are always applied to an entire paragraph. To adjust the spacing in a few characters, but not an entire paragraph, use the Tracking option.

4. Set the Single Word Justification option to specify how you want to justify single-word paragraphs.

In narrow columns, a single word can occasionally appear by itself on a line. If the paragraph is set to full justification, a single word on a line may appear to be too stretched out. Instead of leaving such words fully justified, you can center them or align them to the left or right margins.

Set glyph scaling in justified text

1. Click an insertion point in a paragraph or select the paragraphs you want to affect.
2. Choose Justification from the Paragraph panel menu.
3. Type values for Glyph Scaling Minimum, Desired, and Maximum. Then click OK.

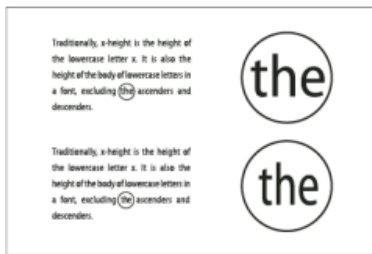

Before (top) and after (bottom) glyph scaling in justified text

 Glyph scaling can help in achieving even justification; however, values more than 3% from the 100% default value may result in distorted letter shapes. Unless you're striving for a special effect, it's best to keep glyph scaling to subtle values, such as 97–100–103.

Use a flush space with justified text

Using a flush space character adds a variable amount of space to the last line of a fully justified paragraph—between the last word and an end-of-story character from a decorative font. Used with nonjustified text, the flush space appears as a normal word space. In justified text, it expands to absorb all available extra space on the last line. Using a flush space can make a dramatic difference in the way the entire paragraph is formatted by the Adobe Paragraph Composer.



Before and after adding a flush space character

1. Using the Type tool , click directly in front of the end-of-story character.
2. Choose Type > Insert White Space > Flush Space.

Note: The effect of a flush space isn't apparent until you apply the Justify All Lines option to the paragraph.

Highlight lines that are too loose or tight

Because composing a line of type involves factors in addition to word spacing and letterspacing (hyphenation preferences, for example), InDesign cannot always honor your settings for word spacing and letterspacing. However, compositional problems in lines of text can be highlighted in yellow; the darkest of three shades indicates the most serious problems.

1. Choose Edit > Preferences > Composition (Windows) or InDesign > Preferences > Composition (Mac OS).
2. Select H&J Violations and click OK.

Adobe also recommends

- Justify text next to wrap objects



Twitter™ and Facebook posts are not covered under the terms of Creative Commons.

[Legal Notices](#) | [Online Privacy Policy](#)

Formatting text

- [Format text](#)
- [Text formatting precedence](#)
- [Copy type attributes \(Eyedropper\)](#)
- [Use Quick Apply](#)



[To the top](#)

Format text

Use the Control panel to change the appearance of text. When text is selected or when the insertion point is placed in text, the Control panel displays either the character formatting controls or the paragraph formatting controls, or a combination of both, depending on your monitor resolution. These same text formatting controls appear in the Character panel and Paragraph panel. You can also use the Character panel and Paragraphs panel to change the appearance of text.

Note the following methods of formatting text:

- To format characters, you can use the Type tool  to select characters, or you can click to place the insertion point, select a formatting option, and then begin typing.
- To format paragraphs, you don't need to select an entire paragraph—selecting any word or character, or placing the insertion point in a paragraph will do. You can also select text in a range of paragraphs.
- To set the formatting for all future text frames that you'll create in the current document, make sure that the insertion point is not active and that nothing is selected, and then specify text formatting options. To set default text formatting for all new documents, close all documents, and then specify the text settings. See [Set defaults](#).
- Select a frame to apply formatting to all text inside it. The frame cannot be part of a thread.
- Use paragraph styles and character styles to format text quickly and consistently.

- Select the Type tool .
- Click to place an insertion point, or select the text that you want to format.
- In the Control panel, click the Character Formatting Control icon  or the Paragraph Formatting Control icon .



Control panel

A. Character formatting controls **B.** Paragraph formatting controls

- Specify formatting options.

[To the top](#)

Text formatting precedence



[To the top](#)

Copy type attributes (Eyedropper)

You can use the Eyedropper tool to copy type attributes such as character, paragraph, fill, and stroke settings, and then apply those attributes to other type. By default, the Eyedropper tool copies all type attributes. To customize the attributes you want to copy with the Eyedropper tool, use the Eyedropper Options dialog box.



The Eyedropper tool is available only in Layout View.

Copy type attributes to unselected text

1. With the Eyedropper tool , click the text that is formatted with the attributes you want to copy. (The text can be in another open document.) The eyedropper pointer reverses direction, and appears full , to indicate that it's loaded with the attributes you copied. When you position the eyedropper pointer over text, an I-beam appears next to the loaded eyedropper .
2. With the Eyedropper tool, select the text you want to change.

The selected text takes on the attributes loaded in the eyedropper. As long as the Eyedropper tool is selected, you can continue to select text to apply formatting.

3. To deselect the Eyedropper tool, click another tool.



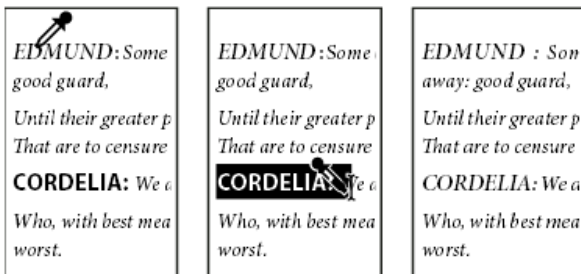

 To clear the formatting attributes currently held by the eyedropper tool, press **Alt** (Windows) or **Option** (Mac OS) while the Eyedropper tool is loaded. The Eyedropper tool reverses direction and appears empty , to indicate that it's ready to pick up new attributes. Click an object containing the attributes you want to copy, and then drop the new attributes on another object.



The eyedropper is clicked on formatted text to copy its formatting (left), and then dragged across unformatted text (middle) to apply that formatting (right).

If you use the Eyedropper tool to copy a paragraph style from text in one document to text in another, and the paragraph style has the same name but different sets of attributes, any style differences will appear as local overrides to the destination style.

Copy type attributes to selected text

1. With the Type tool  or Path Type tool , select the text to which you want to copy attributes.
2. Using the Eyedropper tool , click the text from which you want to copy attributes. (The text from which you want to copy attributes must be in the same InDesign document as the text you want to change.) The Eyedropper tool reverses direction and appears full , to indicate that it's loaded with the attributes you copied. The attributes are applied to the text you selected in step 1.

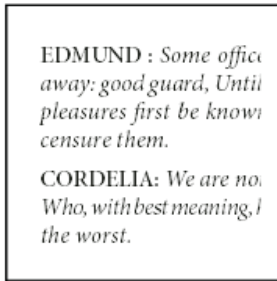

Type attributes copied to selected text

Change which text attributes the Eyedropper tool copies

1. In the toolbox, double-click the Eyedropper tool.
2. Choose Character Settings or Paragraph Settings in the Eyedropper Options dialog box.
3. Select the attributes you want to copy with the Eyedropper tool, and then click OK.

 To copy or apply paragraph attributes only without having to change settings in the Eyedropper Options dialog box, hold down Shift as you click text with the Eyedropper tool.

[To the top](#)

Use Quick Apply

Use Quick Apply to find and apply styles, menu commands, scripts, variables, and most other commands that can be found in the Keyboard Shortcuts dialog box.

1. Select the text or frame to which you want to apply the style, menu command, script, or variable.
2. Choose Edit > Quick Apply, or press Ctrl+Enter (Windows) or Command+Return (Mac OS).
3. Start typing the name of the item you want to apply.

The name you type doesn't need to be an exact match. For example, typing **he** will locate styles such as Head 1, Head 2, and Subhead, as well as Help menu commands such as Help Menu > InDesign Help.

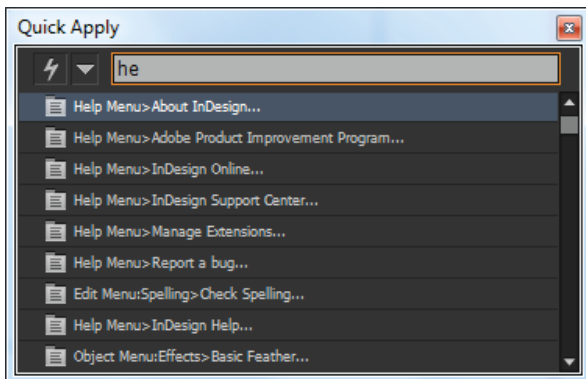

Use Quick Apply to find styles, menu commands, scripts, and variables.



 You can narrow the search to only a single category by typing the appropriate prefix at the beginning of the search, such as **m**: for menu or **p**: for paragraph styles. To view a list of prefixes, click the down arrow to the left of the Quick Apply text box. You can deselect categories in this list that you don't want to appear.

4. Select the item you want to apply, and then:

- To apply a style, menu command, or variable, press Enter or Return.
- To apply a paragraph style and remove overrides, press Alt+Enter (Windows) or Option+Return (Mac OS).
- To apply a paragraph style and remove overrides and character styles, press Alt+Shift+Enter (Windows) or Option+Shift+Return (Mac OS).
- To apply an item without closing the Quick Apply list, press Shift+Enter (Windows) or Shift+Return (Mac OS).
- To close the Quick Apply list without applying an item, press Esc or click anywhere else in the document window.
- To edit a style, press Ctrl+Enter (Windows) or Command+Return (Mac OS).

 When the Quick Apply list is displayed, press the left and right arrow keys to scroll through the edit field; press the up and down arrow keys to scroll through the list of items.

Adobe also recommends

- Apply colors using the Eyedropper tool

 Twitter™ and Facebook posts are not covered under the terms of Creative Commons.

[Legal Notices](#) | [Online Privacy Policy](#)

Bullets and numbering

- [Create bulleted or numbered lists](#)
- [Format a bulleted or numbered list](#)
- [Change bullet characters](#)
- [Change numbered list options](#)
- [Defining lists](#)
- [Create a paragraph style for running lists](#)
- [Create multi-level lists](#)
- [Create running captions for figures and tables](#)
- [Restart or continue numbering for a list](#)
- [Convert list bullets or numbers to text](#)

[To the top](#)

Create bulleted or numbered lists

In bulleted lists, each paragraph begins with a bullet character. In numbered lists, each paragraph begins with an expression that includes a number or letter and a separator such as a period or parenthesis. The numbers in a numbered list are updated automatically when you add or remove paragraphs in the list. You can change the type of bullet or numbering style, the separator, the font attributes and character styles, and the type and amount of indent spacing.

You cannot use the Type tool to select the bullets or numbers in a list. Instead, edit their formatting and indent spacing using the Bullets And Numbering dialog box, the Paragraph panel, or the Bullets And Numbering section of the Paragraph Styles dialog box (if the bullets or numbers are part a style).

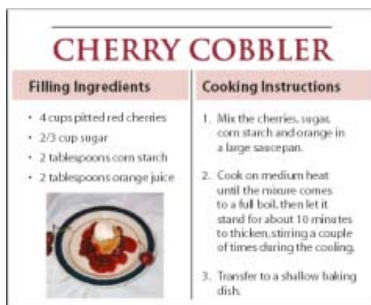



Bulleted list and numbered list

A quick way to create a bulleted or numbered list is to type the list, select it, and then click the Bulleted List or Numbered List button in the Control panel. These buttons let you turn the list on or off and switch between bullets and numbers. You can also make bullets and numbering part of a paragraph style and construct lists by assigning styles to paragraphs.

Note: *Automatically generated bullet and number characters aren't actually inserted in the text. Therefore, they cannot be found during a text search or selected with the Type tool unless you convert them to text. In addition, bullets and numbering don't appear in the story editor window (except in the paragraph style column).*



InDesign Docs provides a series of articles about using bullets and numbering to create [outlines](#), [multi-level lists](#), [figure captions](#), and [numbered steps](#).

1. Select the set of paragraphs that will become the list, or click to place the insertion point where you want the list to begin.
2. Do any of the following:

- Click the Bulleted List button  or the Numbered List button  in the Control panel (in Paragraph mode). Hold down Alt (Windows) or Option (Mac OS) while clicking a button to display the Bullets And Numbering dialog box.
 - Choose Bullets And Numbering from the Paragraph panel or Command panel. For List Type, choose either Bullets or Numbers. Specify the settings you want, and then click OK.
 - Apply a paragraph style that includes bullets or numbering.
3. To continue the list in the next paragraph, move the insertion point to the end of the list and press Enter or Return.
 4. To end the list (or list segment, if the list is to be continued later in the story), click the Bulleted List or Numbered List button in the Control panel again, or choose Bullets And Numbering from the Paragraph panel menu.

[To the top](#)

Format a bulleted or numbered list

1. Using the Type tool , select the bulleted or numbered paragraphs you want to reformat.
2. Do any of the following to open the Bullets And Numbering dialog box:
 - Choose Bullets And Numbering from the Control panel menu (in Paragraph mode) or the Paragraph panel menu.
 - Alt-click (Windows) or Option-click (Mac OS) either the Bulleted List button  or the Numbered List button .
3. In the Bullets And Numbering dialog box, do any of the following:
 - Change the bullet character.
 - Change the numbered list options.
 - Choose a style for the numbers or bullets from the Character Style list.
4. To change the position of the bullet or number, specify any of the following:

Alignment Left-aligns, centers, or right-aligns the bullets or numbers within the horizontal space allotted for numbers. (If this space is narrow, the difference between the three options is negligible.)

Left Indent Specifies how far the lines after the first line are indented.

First Line Indent Controls where the bullet or number is positioned.

Increase the First Line Indent value if you want the punctuation in long lists to be aligned. For example, if you want “9.” and “10.” to be aligned on the period, change the Alignment to Right and gradually increase the first line indent until the numbers align (make sure Preview is turned on).

To create the hanging indent effect, specify a positive Left Indent value (such as 2p0), and then specify an equal negative value (such as -2p0) for First Line Indent.

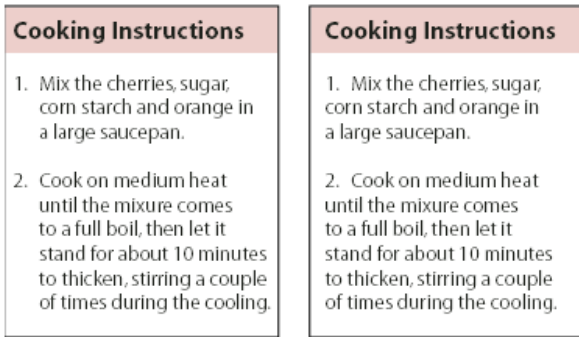

A

B

Position settings

Note: The *Left Indent*, *First Line Indent*, and *Tab Position* settings in the *Bullets And Numbering* dialog box are paragraph attributes. For that reason, changing these settings in the *Paragraph* panel also changes bulleted and numbered list formats.

Tab Position Activates the tab position to create space between the bullet or number and the start of the list item.

By default, bullets and numbers inherit some of their text formatting from the first character in the paragraph to which they're attached. If the first character in one paragraph is different from the first characters in other paragraphs, the numbering or bullet character may appear inconsistent with the other list items. If this is not the formatting you desire, create a character style for numbers or bullets and apply it to your list by using the *Bullets And Numbering* dialog box.

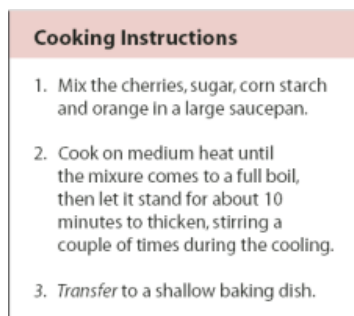

Italicized first word of step 3 causes numbering to be italicized as well, unless you create character style for numbers and apply it to list.

[To the top](#)

Change bullet characters

If you don't want to use one of the existing bullet characters, you can add other bullet characters to the *Bullet Character* grid. A bullet character that is available in one font may not be available in another font. You can choose whether the font is remembered with any bullet character you add.

If you want to use a bullet found in a specific font (such as the pointing hand from *Dingbats*), be sure to set the bullet to remember that font. If you use a basic bullet character, it's probably best not to remember the font, because most fonts have their own version of that bullet character. Depending on whether you select the *Remember Font With Bullet* option, a bullet you add can reference either a *Unicode* value and a specific font family and style, or just a *Unicode* value.

Note: *Bullets that reference only the Unicode value (without a remembered font) appear with a red "u" indicator.*

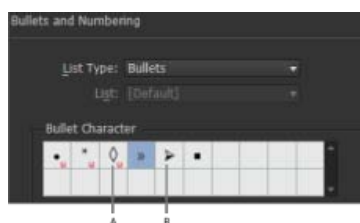

Change the bullet character

1. On the Control panel menu or Paragraph panel menu, select Bullets And Numbering.
2. In the Bullets And Numbering dialog box, select Bullets from the List Type menu.
3. Select a different bullet character, and then click OK.

Add a bullet character

1. In the Bullets And Numbering dialog box, select Bullets from the List Type menu, then click Add.
2. Select the glyph that you want to use as the bullet character. (Different font families and font styles contain different glyphs.)
3. If you want the new bullet to remember the currently chosen font and style, select Remember Font With Bullet.
4. Click Add.

Note: The list of bullet characters is stored in the document, like paragraph and character styles. When you paste or load paragraph styles from another document, any bullet character used in those styles appears in the Bullets And Numbering dialog box, along with the other bullets defined for the current document.

Remove a bullet character

1. In the Bullets And Numbering dialog box, select Bullets from the List Type menu.
2. Select the bullet character you want to remove, and click Delete. (The first preset bullet character cannot be deleted.)

[To the top](#)

Change numbered list options

In a numbered list, the numbers are updated automatically when you add or remove paragraphs in the list. Paragraphs that are part of the same list are numbered sequentially. These paragraphs do not have to be consecutive to one another as long as you define a list for the paragraphs.

You can also create a multi-level list, in which list items are numbered in outline form and are indented by different degrees.

1. Open the Bullets And Numbering dialog box.
2. Under Numbering Style, select the type of numbering you want to use from the Format menu.
3. In the Number box, use the default expression—period (.) and tab space (^t)—or construct a number expression of your own. To enter a number expression, delete the period after the number metacharacter (^#) and do one of the following:

- Type a character (such as a closing parenthesis) or more than one character in place of the period.

Tip: You can also input a full-width separator instead of a half-width period separator, which is especially useful for vertical text.

- Choose an item (such as Em Dash or Ellipses) from the Insert Special Character menu.
 - Type a word or character before the number metacharacter. For example, to number questions in a list, you can type the word **Question**.
4. Choose a character style for the expression. (The style you choose applies to the entire number expression, not just to the number.)
5. For Mode, choose one of the following options:

Continue From Previous Number Numbers lists sequentially.

Start At Starts numbering at a number or other value that you enter in the text box. Enter a number, not a letter, even if your list uses letters or Roman numerals for numbering.

6. Specify any other options, and then click OK.

[To the top](#)

Defining lists

A defined list can be interrupted by other paragraphs and lists, and can span different stories and different documents in a book. For example, use defined lists to create a multi-level outline, or to create a running list of numbered table names throughout your document. You can also define lists for separately numbered or bulleted items that are mixed together. For example, in a list of questions and answers, define one list for numbering the questions and another for numbering the answers.

Defined lists are often used to track paragraphs for numbering purposes. When you create a paragraph style for numbering, you can assign the style to a defined list, and paragraphs are numbered in that style according to where they appear in the defined list. The first paragraph to appear is given number 1 (“Table 1”), for example, and the next paragraph is given number 2 (“Table 2”), even if it appears several pages later. Because both paragraphs belong to the same defined list, they can be numbered consecutively no matter how far apart they are in the document or book.

Define a new list for each type of item you want to number—step-by-step instructions, tables, and figures, for example. By defining multiple lists, you can interrupt one list with another and maintain number sequences in each list.

 *If list items appear in unthreaded frames on the same page, items are numbered in the order in which the text frames are added to the page. To reorder the items, cut and paste the text frames one by one in the order in which you want them to be listed.*

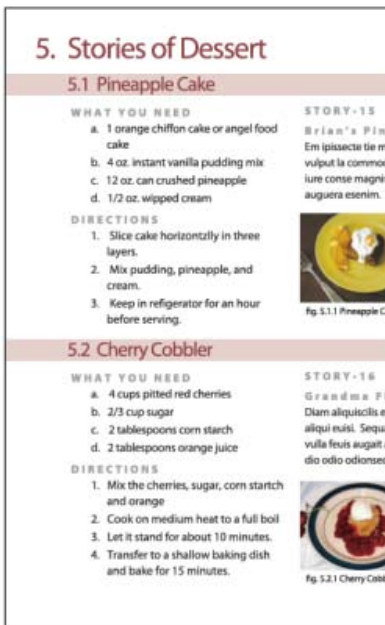

Defined lists let you interrupt one list with another.

Define a list

1. Choose Type > Bulleted And Numbered Lists > Define Lists.
2. Click New in the Define Lists dialog box.
3. Enter a name for the list, choose whether you want to continue numbering across stories, and continue numbering from previous documents in your book.
4. Click OK twice.

After you define a list, you can use it in a paragraph style, such as a style for tables, figures, or ordered lists, as well as apply it by way of the Control panel and Paragraph panel.

Note: Some lists are defined automatically. For example, when you import a numbered list from a Microsoft Word document, InDesign defines a list automatically for your document.

Edit a defined list

1. Choose Type > Bulleted And Numbered Lists > Define Lists.
2. Select a list and click Edit.
3. Enter a new name for the list or change your selection of Continue Numbers options.

Paragraph styles that are assigned to the list are reassigned to the list under its new name.

Delete a defined list

1. Choose Type > Bulleted And Numbered Lists > Define Lists.
2. Select a list.
3. Click Delete, and then select a different list or the [Default] list to replace your list with.

[To the top](#)

Create a paragraph style for running lists

To create a *running list*—a list that is interrupted by other paragraphs or that spans multiple stories or documents—create a paragraph style and apply the style to paragraphs that you want to be part of the list. For example, to create a running list of the tables in your document, create a paragraph style called Tables, make a defined list part of the style, and then apply the Tables paragraph style to all paragraphs you want in your Table list.

InDesign Docs provides a series of articles about using bullets and numbering to create [figure captions](#) and [numbered steps](#).

1. Choose New Paragraph Style from the Paragraph Styles panel menu.
2. Enter a style name.

3. On the left side of the New Paragraph Style dialog box, click Bullets And Numbering.
4. For List Type, select Bullets or Numbering.
5. If you are creating a style for numbered lists, choose a defined list from the List menu, or choose New List and define the list.
6. Specify the bullet or numbering characteristics.
7. Use the Bullet or Number Position section of the New Paragraph Style dialog box to change the indent spacing. For example, to create a hanging indent, type 2p for Left Indent and -2p for First Line Indent.
8. Specify other paragraph style attributes for the style, and then click OK.

[To the top](#)

Create multi-level lists

A *multi-level list* is a list that describes hierarchical relationships between the list paragraphs. These lists are also called *outline lists* because they resemble outlines. The list's numbering scheme (as well as indentations) show rank as well as how items are subordinate to one another. You can tell where each paragraph fits in the list with respect to the paragraphs before and after it. You can include up to nine levels in a multi-level list.

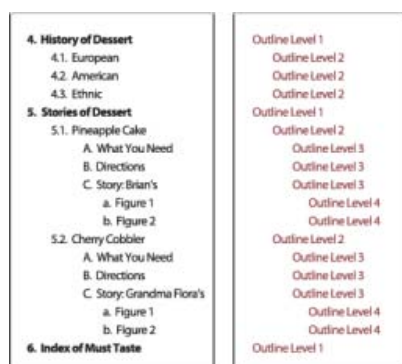

Multi-level list with numbers and letters marking hierarchy levels

To create a multi-level list, define the list and then create a paragraph style for each level you want. For example, a list with four levels requires four paragraph styles (each one assigned the same defined list). As you create each style, you define its numbering format and paragraph formatting.

Gabriel Powell provides a video tutorial about creating outlines and multi-level lists at [Creating an automatic numbered list](#).

Bob Bringhurst provides a series of articles about using bullets and numbering to create [outlines](#), [multi-level lists](#), [figure captions](#), and [numbered steps](#).

1. Choose New Paragraph Style from the Paragraph Styles panel menu.
2. Enter a style name.
3. If you already created a style for your multi-level list, choose the style you will assign to levels above this one from the Based On menu; otherwise, choose No Paragraph Style or Basic Paragraph.
4. On the left side of the New Paragraph Style dialog box, click Bullets And Numbering.
5. Choose Numbers from the List Type menu.

6. Choose a list you defined from the List menu. If you haven't yet defined your list, you can choose New List from the menu and define it now.
7. In the Level box, enter a number that describes which level of the multi-level list you're creating a style for.
8. From the Format menu, choose the type of numbering you want to use.
9. In the Number box, enter metacharacters or select metacharacters from the menus to describe the number formatting you want for list items at this level.
 - To include numbering prefixes from higher levels, enter text or click at the start of the Number box and choose Insert Number Placeholder and then select a Level option (for example, Level 1), or enter ^ and then the list level (for example, enter ^1). In a list with first levels numbered 1, 2, 3, and so on, and second levels numbered a, b, c, and so on, including the first-level prefix in the second level renders second-level numbers as 1a, 1b, 1c; 2a, 2b, 2c; 3a, 3b, 3c.
 - To create a number expression, enter punctuation, enter metacharacters, or select options on the Insert Special Character list.
10. Select Restart Numbers At This Level After to renumber beginning at 1 when a paragraph at this level appears after a paragraph at a higher level; deselect this option to number paragraphs at this level consecutively throughout the list without regard for where the paragraphs appear in the list hierarchy.

To restart numbers after a specific level or range of levels, type the level number or range (such as 2-4) in the Restart Numbers At This Level After field.
11. In the Bullet or Number Position area, choose Indent or Tab Position options to indent list items at this level farther than list items at higher levels. Indenting helps subordinate items in lists stand out.
12. Click OK.

In some cases, such as with numbered steps, you may want to restart numbering within the same story. To avoid restarting the numbered list manually, create a separate style that's identical to the Level 1 style with one exception. For Mode, chose Start At, and then specify 1. Name this style something like "Level 1 Restart."

[To the top](#)

Create running captions for figures and tables

Running captions number figures, tables, and other items consecutively in a document. For example, the first figure caption starts with the words "Figure 1," the second with "Figure 2," and so on. To make sure that figures, tables, or similar items are numbered consecutively, define a list for the item, and then create a paragraph style that includes the list definition. You can also add descriptive words such as "Figure" or "Table" to the numbering scheme of the paragraph style.

Bob Bringhurst provides an article about creating figure captions at [Numbered Lists Part III - Figure Captions](#).

 *List items are numbered in the order in which they are added to the page. To reorder the items, cut and paste the items one by one in the order in which you want them to be listed.*

1. Create a new paragraph style and, in the Bullets And Numbering section of the Paragraph Style Options dialog box, choose Numbers from the List Type menu.
2. Choose a defined list from the List menu (or choose New List to define a list).
3. Under Numbering Style, select the type of numbering you want to use from the Format menu.

For example, select the A, B, C, D... option to create a list for "Figure A," "Figure B," and so on.

4. In the Number box, enter a descriptive word and any spacing or punctuation (as needed) along with the numbering metacharacters.

For example, to create a “Figure A” effect, enter the word “Figure” and a space before the numbering metacharacters (such as **Figure** ^#. ^t). This adds the word “Figure” followed by a sequential number (^#), a period, and a tab (^t).

Note: To include chapter numbers in running captions, choose *Insert Number Placeholder > Chapter Number* from the Number list, or enter ^H where you want the chapter number to appear in the number scheme.

5. Finish creating the style and click OK.

After you create the style, apply it to text figure captions or table titles.

 You can use the *Table Of Contents* feature to generate a list of tables or figures.

[To the top](#)

Restart or continue numbering for a list

InDesign offers commands for restarting a list and continuing a list:

Restarting a numbered list Place the insertion point in the paragraph and choose *Restart Numbering* from the context menu or choose *Type > Bulleted And Numbered Lists > Restart Numbering*. In normal lists, this command assigns the number 1 (or letter A) to a paragraph and makes it the first paragraph in a list. In multi-level lists, this command assigns the first lower-level number to a nested paragraph.

Continuing a numbered list Choose *Continue Numbering* from the context menu or choose *Type > Bulleted And Numbered Lists > Continue Numbering*. This command resumes numbering a list that was interrupted by commentary, graphics, or nested list items. InDesign also offers commands for numbering lists that begin in one story or book and cross into the next story or book.

Number a list from the previous or current story

Whether a list resumes numbering from the previous story or starts numbering anew in the current story depends on how the list is defined.

1. Choose *Type > Bulleted And Numbered Lists > Define Lists*.
2. Select a list and click the *Edit* button.

Don't choose the *Default* list because it can't run across stories.

3. Select *Continue Numbers Across Stories* to resume numbering the list from the previous story, or deselect this option to start the list in the current story at 1 (or A).
4. Click *OK* twice.

Number a list from the previous or current document in a book

Whether a list resumes numbering from the previous document in a book or starts numbering anew in the current document depends on how the list is defined.

1. Choose *Type > Bulleted And Numbered Lists > Define Lists*.

2. Select a list and click the Edit button.
3. Select Continue Numbers From Previous Document In Book to resume numbering the list from the previous document (you must choose Continue Numbers Across Stories to activate this option), or deselect this option to start the list in the current document at 1 (or A).
4. Click OK twice.

 *To make sure that numbering is updated properly in a book, synchronize the documents in the book and choose Update Numbering > Update All Numbers from the books panel menu.*

[To the top](#)

Convert list bullets or numbers to text

1. Select the paragraphs containing the bulleted or numbered list.
2. Do one of the following:
 - From the Paragraph panel menu, choose Convert Numbering To Text or Convert Bullets To Text.
 - Right-click (Windows) or Command-click (Mac OS) the selection, and then choose Convert Numbering To Text or Convert Bullets To Text.

Note: *To remove the list numbers or bullets, click the Numbered List button or Bulleted List button to unapply list formatting to the selected text.*

Adobe also recommends

 Twitter™ and Facebook posts are not covered under the terms of Creative Commons.

[Legal Notices](#) | [Online Privacy Policy](#)

Leading

[About leading](#)
[Change leading](#)

[To the top](#)

About leading

The vertical space between lines of type is called *leading*. Leading is measured from the baseline of one line of text to the baseline of the line above it. *Baseline* is the invisible line on which most letters—that is, those without descenders—sit.

The default auto-leading option sets the leading at 120% of the type size (for example, 12-point leading for 10-point type). When auto-leading is in use, InDesign displays the leading value in parentheses in the Leading menu of the Character panel.

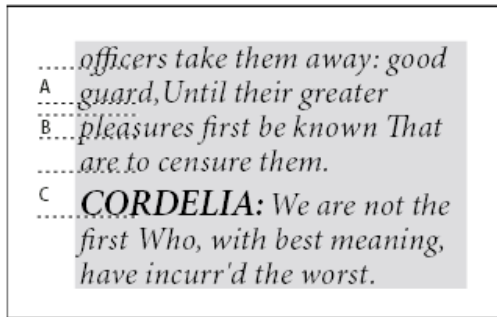

Leading

A. Leading **B.** Text height **C.** Larger text size of one word increases leading for that one line.

[To the top](#)

Change leading

By default, leading is a character attribute, which means that you can apply more than one leading value within the same paragraph. The largest leading value in a line of type determines the leading for that line. However, you can select a preferences option so that leading applies to the entire paragraph, instead of to text within a paragraph. This setting does not affect the leading in existing frames.

Change leading of selected text

1. Select the text you want to change.
2. Do any of the following:
 - In the Character panel or Control panel, choose the leading you want from the Leading menu .
 - Select the existing leading value and type a new value.
 - While creating a paragraph style, change the leading using the Basic Character Formats panel.

If InDesign ignores the leading change, it may be due to Vertical Justification or Align To Baseline Grid being selected. Choose Object > Text

Frame Options and make sure Vertical Justification is set to Top, and make sure Do Not Align To Baseline Grid is selected in the Paragraph panel, Control panel, or paragraph style.

 You can also adjust vertical space by aligning text to the baseline grid. When baseline grid is set, the baseline grid setting takes precedence over the leading value.

Change the default leading percentage

1. Select the paragraphs that you want to change.
2. Choose Justification from the Paragraph panel menu or from the Control panel menu.
3. For Auto Leading, specify a new default percentage. The minimum value is 0%, and the maximum value is 500%.

Note: The Auto option in the Leading pop-up menu of the Control panel menu sets Auto Leading value in the Justification dialog box as a ratio (%) of character size. The default is 175% for text frames and 100% for frame grids.

Apply leading to whole paragraphs

1. Choose Edit > Preferences > Type (Windows) or InDesign > Preferences > Type (Mac OS).
2. Select Apply Leading To Entire Paragraph, and then click OK.

Note: When you use a character style to apply leading to text, the leading affects only the text to which the style is applied, not the entire paragraph, regardless of whether the Apply Leading To Entire Paragraph option is selected.

 Twitter™ and Facebook posts are not covered under the terms of Creative Commons.

[Legal Notices](#) | [Online Privacy Policy](#)

Tabs and indents

Tabs dialog box overview

Set tabs

Repeat tabs

Move, delete, and edit tab settings

Specify characters for decimal tabs

Add tab leaders

Insert right indent tabs

Set indents

[To the top](#)

Tabs dialog box overview

Tabs position text at specific horizontal locations in a frame. The default tab settings depend on the Horizontal ruler units setting in the Units & Increments preferences dialog box.

Tabs apply to an entire paragraph. The first tab you set deletes all default tab stops to its left. Subsequent tabs delete all default tabs between the tabs you set. You can set left, center, right, and decimal or special-character tabs.

You set tabs using the Tabs dialog box.

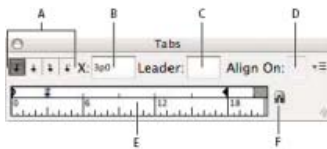

Tabs dialog box

A. Tab alignment buttons **B.** Tab position **C.** Tab Leader box **D.** Align On box **E.** Tab ruler **F.** Snap above frame

When you do this in a vertical text frame, the Tabs dialog box also becomes vertical. When the Tabs dialog box direction is not consistent with the text frame direction, click on the magnet icon  to snap the rulers to the current text frame.



Vertical tabs

Open the Tabs dialog box

1. Using the Type tool, click in the text frame.

2. Choose Type > Tabs.

If the top of the frame is visible, the Tabs dialog box snaps to the current text frame and matches its width to the current column.

When the top of a horizontal frame is displayed, the Tabs dialog box will snap to the top of the current text frame, and the width will change to conform to the width of the current column. When there is a text insertion point in a vertical frame, the Tabs dialog box will snap to the right side of the text frame, and the length displayed will conform to the length of the current column.

Align the Tabs dialog box ruler with your text

1. In Layout View, scroll through your document to display the top of the content.
2. Scroll through your document to display the top of the text frame.
3. Click the magnet icon  on the Tabs dialog box. The Tabs dialog box snaps to the top of the column that includes the selection or the insertion point.

[To the top](#)

Set tabs

You can set left, center, right, and decimal or special-character tabs. When you use the special-character tab, you can set a tab to align to any character you choose, such as a colon or a dollar sign.

Bob Bringhurst provides an article about various tab and indent effects at [Tabs and Indents Gallery](#).

1. To see the effect of changing tab settings, choose View > Layout View.
2. Using the Type tool , click an insertion point in the paragraph.
3. Press the Tab key. Add tabs in the paragraphs where you want to add horizontal space. (You can also add tabs after you create your tab settings.)

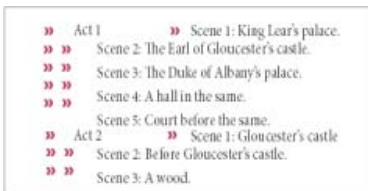

Using tabs to align text

4. Choose Type > Tabs to display the Tabs dialog box.
5. To specify which paragraphs will be affected, select a paragraph or a group of paragraphs.

Note: In Galley view and Story view, adding a tab at the beginning of the paragraph indents the text the same amount, regardless of the tab position. Layout view shows the actual distance of the tab.

6. For the first tab, click a tab-alignment button (left, right, center, or decimal) in the Tabs dialog box to specify how text will align to the tab's position.

7. Do one of the following:

- Click a location on the tab ruler to position a new tab.

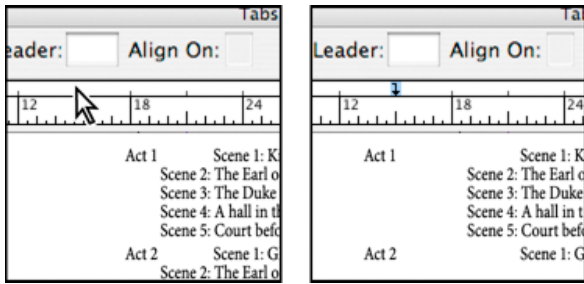

Adding a new tab setting

- Type a position in the X box and press Enter or Return. If the X value is selected, press the up or down arrow key to increase or decrease the tab value by 1 point, respectively.

8. For subsequent tabs with different alignments, repeat steps 3 and 4.

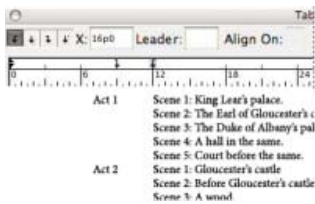

The first tab setting is right-aligned; the second tab setting is left-aligned.

 To insert a tab character in a table, choose *Type > Insert Special Character > Other > Tab*.

[To the top](#)

Repeat tabs

The Repeat Tab command creates multiple tabs based on the distance between the tab and the left indent or the previous tab stop.

1. Click an insertion point in the paragraph.
2. In the Tabs panel, select a tab stop on the ruler.
3. Choose Repeat Tab from the panel menu.

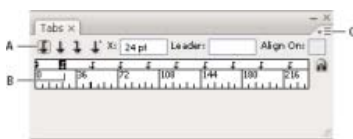

Repeated tabs

A. Tab-alignment buttons **B.** Tab stop on the ruler **C.** Panel menu

[To the top](#)

Move, delete, and edit tab settings

Use the Tabs dialog box to move, delete, and edit tab settings.

Move a tab setting

1. Using the Type tool , click an insertion point in the paragraph.
2. In the Tabs dialog box, select a tab on the tab ruler.
3. Do one of the following:
 - Type a new location for X and press Enter or Return.
 - Drag the tab to a new location.

Delete a tab setting

1. Click an insertion point in the paragraph.
2. Do one of the following:
 - Drag the tab off the tab ruler.
 - Select the tab, and choose Delete Tab from the panel menu.
 - To return to the default tab stops, choose Clear All from the panel menu.

Change a tab from one alignment to another

1. In the Tabs dialog box, select a tab on the tab ruler.
2. Click a tab-alignment button.

 You can also hold down *Alt* (Windows) or *Option* (Mac OS) while clicking the tab setting to cycle through the four alignment options.

[To the top](#)

Specify characters for decimal tabs

You use decimal tabs to align text with a character you specify, such as a period or a dollar sign.

1. In the Tabs panel, create or select a decimal tab  on the tab ruler.
2. In the Align On box, type the character to which you want to align. You can type or paste any character. Make sure that the paragraphs you're aligning contain that character.

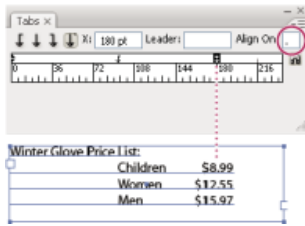

Text aligned using a decimal tab

[To the top](#)

Add tab leaders

A *tab leader* is a repeated pattern of characters, such as a series of dots or dashes, between a tab and the following text.

1. In the Tabs panel, select a tab stop on the ruler.
2. Type a pattern of as many as eight characters in the Leader box, and then press Enter or Return. The characters you entered repeat across the width of the tab.
3. To change the font or other formatting of the tab leader, select the tab character in the text frame, and use the Character panel or Type menu to apply formatting.

[To the top](#)

Insert right indent tabs

In one step, you can add a right-aligned tab at the right indent, making it easier to prepare tabular text that spans an entire column. Right indent tabs are slightly different from regular tabs. A right indent tab:

- Aligns all subsequent text to the right edge of the text frame. If the same paragraph includes any tabs after the right indent tab, those tabs and their text are pushed to the next line.
- Is a special character located in the text, not in the Tabs dialog box. You add a right indent tab using a context menu, not the Tabs dialog box. As a result, a right indent tab can't be part of a paragraph style.
- Is different from the Right Indent value in the Paragraph panel. The Right Indent value keeps the entire right edge of the paragraph away from the right edge of the text frame.
- Can be used with a tab leader. Right indent tabs use the tab leader of the first tab stop past the right margin, or, if there isn't one, the last tab stop before the right margin.

1. Using the Type tool **T**, click on the line where you want to add the right indent tab.
2. Choose Type > Insert Special Character > Other > Right Indent Tab.

[To the top](#)

Set indents

Indents move text inward from the right and left edges of the frame. In general, use first-line indents, not spaces or tabs, to indent the first line of a paragraph.

A first-line indent is positioned relative to the left-margin indent. For example, if a paragraph's left edge is indented one pica, setting the first-line indent to one pica indents the first line of the paragraph two picas from the left edge of the frame or inset.

You can set indents using the Tabs dialog box, the Paragraph panel, or the Control panel. You can also set indents when you create bulleted or

numbered lists.

When setting CJK characters, you can use the mojikumi setting to specify the indent for the first line. However, for text in which the first line indent was specified in the Paragraph panel, if you specify indents in mojikumi settings, you can make the text indent the sum value of both indents.

Bob Bringhurst provides an article about various tab and indent effects at [Tabs and Indents Gallery](#).

Set an indent using the Tabs dialog box

1. Using the Type tool **T**, click in the paragraph you want to indent.
2. Choose Type > Tabs to display the Tabs dialog box.
3. Do one of the following to the indent markers **▶** in the Tabs dialog box:
 - Drag the top marker to indent the first line of text. Drag the bottom marker to move both markers and indent the entire paragraph.

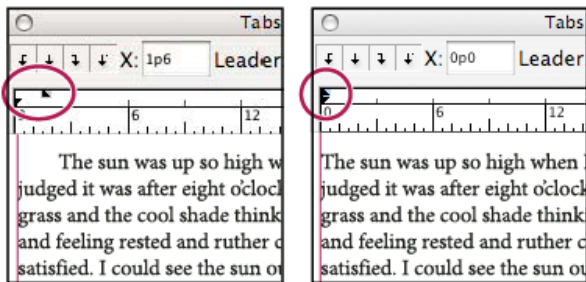

First-line indent (left) and no indent (right)

- Select the top marker and type a value for X to indent the first line of text. Select the bottom marker and type a value for X to move both markers and indent the entire paragraph.

For more information on using the Tabs dialog box, see [Tabs dialog box overview](#).

Set indents using the Paragraph panel or the Control panel

1. Using the Type tool **T**, click in the paragraph you want to indent.
2. Adjust the appropriate indent values in the Paragraph panel or Control panel. For example, do the following:
 - To indent the entire paragraph one pica, type a value (such as **1p**) in the Left Indent box **⌘**.
 - To indent only the first line of a paragraph one pica, type a value (such as **1p**) in the First Line Left Indent box **⌘**.
 - To create a hanging indent of one pica, type a positive value (such as **1p**) in the Left Indent box and type a negative value (such as **-1p**) in the First Line Left Indent box. See [Set indents](#).

Reset indents

1. Click in the paragraph in which you want to reset indents to the zero mark.
2. Choose Reset Indents from the Tabs dialog box menu.

Create a hanging indent

In a hanging indent, all the lines in a paragraph are indented except for the first line. Hanging indents are especially useful when you want to add inline graphics at the beginning of the paragraph.

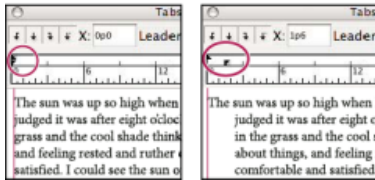

No indent (left) and hanging indent (right)

1. Using the Type tool **T**, click in the paragraph you want to indent.
2. In the Tabs dialog box or the Control panel, specify a left indent value greater than zero.
3. To specify a negative first-line left indent value, do one of the following:
 - In the Control panel, type a negative value for the first-line left indent .
 - In the Tabs dialog box, drag the top marker to the left, or select the marker and type a negative value for X.

In most cases, you'll specify the negative equivalent of the value you entered in step 2; for instance, if you specified a left indent of 2 picas, your first-line left indent will typically be -2 picas.

Right-indent the last line of a paragraph

You can use the Last Line Right Indent option to add a hanging indent on the right side of the last line in a paragraph. This option is especially useful for right-aligning prices in a sales catalog.

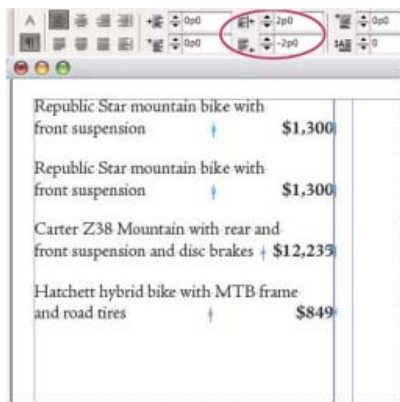

Last line right indent

1. Type your paragraphs. In the last line of each paragraph, place the insertion point before the text to be indented, and choose Type > Insert Special Character > Other > Right Indent Tab.
2. Select the paragraphs.
3. To create a right indent for paragraphs, specify a value (such as **2p**) in the Right Indent field of the Paragraph panel or Control panel.
4. To offset the right indent value for the text that follows the tab, type a negative value (such as **-2p**) in the Last Line Right Indent field of the Paragraph panel or Control panel.

Use Indent To Here

You can use the Indent To Here special character to indent lines in a paragraph independently of a paragraph's left indent value. The Indent To Here special character is different from the paragraph's left indent in the following ways:

- Indent To Here is part of the text flow, as if it were a visible character. If text reflows, the indent moves with it.
- Indent To Here affects all lines after the line where you've added its special characters, so you can indent just some of the lines in a paragraph.
- When you choose Type > Show Hidden Characters, the Indent To Here character **¶** is visible.

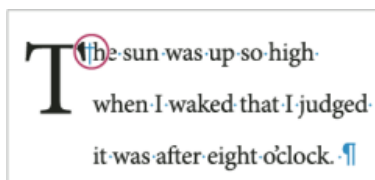

Indent To Here special character

1. Using the Type tool **T**, click the insertion point where you would like to indent.
2. Choose Type > Insert Special Character > Other > Indent To Here.

Adobe also recommends

 Twitter™ and Facebook posts are not covered under the terms of Creative Commons.

[Legal Notices](#) | [Online Privacy Policy](#)

Kerning and tracking

[About kerning and tracking](#)
[Apply kerning to text](#)
[Adjust kerning between words](#)

[To the top](#)

About kerning and tracking

Kerning is the process of adding or subtracting space between specific pairs of characters. *Tracking* is the process of loosening or tightening a block of text.

Note: Values for kerning and tracking affect Japanese text but normally these options are used to adjust the *aki* between roman characters.

Types of kerning

You can automatically kern type using metrics kerning or optical kerning. *Metrics kerning* uses kern pairs, which are included with most fonts. Kern pairs contain information about the spacing of specific pairs of letters. Some of these are: LA, P., To, Tr, Ta, Tu, Te, Ty, Wa, WA, We, Wo, Ya, and Yo.

InDesign uses metrics kerning by default so that specific pairs are automatically kerned when you import or type text. To disable metrics kerning, select "0".

Optical kerning adjusts the spacing between adjacent characters based on their shapes. Some fonts include robust kern-pair specifications. However, when a font includes only minimal built-in kerning or none at all, or if you use two different typefaces or sizes in one or more words on a line, you may want to use the *optical kerning* option.

Optical kerning adjusts the spacing between adjacent characters based on their shapes, and is optimized for use with Roman glyphs. Some fonts include robust kern-pair specifications. However, when a font includes only minimal built-in kerning or none at all, or if you use two different typefaces or sizes in one or more words on a line, you may want to use the *optical kerning* option for the Roman text in your document.



Before applying the optical kerning option to the "W" and "a" pair (top), and after (bottom)

You can also use *manual kerning*, which is ideal for adjusting the space between two letters. Tracking and manual kerning are cumulative, so you can first adjust individual pairs of letters, and then tighten or loosen a block of text without affecting the relative kerning of the letter pairs.

Word kerning isn't the same as the Word Spacing option in the Justification dialog box; word kerning changes the kerning value only between a specific word's first character and the word space preceding that character.

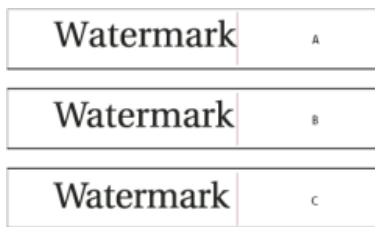

Kerning and tracking

A. Original **B.** Kerning applied between “W” and “a” **C.** Tracking applied

How kerning and tracking are measured

You can apply kerning, tracking, or both to selected text. Tracking and kerning are both measured in 1/1000 em, a unit of measure that is relative to the current type size. In a 6-point font, 1 em equals 6 points; in a 10-point font, 1 em equals 10 points. Kerning and tracking are strictly proportional to the current type size.

Tracking and manual kerning are cumulative, so you can first adjust individual pairs of letters, and then tighten or loosen a block of text without affecting the relative kerning of the letter pairs.



When you click to place the insertion point between two letters, InDesign displays kerning values in the Character panel and the Control panel. Metrics and optical kerning values (or defined kern pairs) appear in parentheses. Similarly, if you select a word or a range of text, InDesign displays the tracking values in the Character panel and Control panel.

[To the top](#)

Apply kerning to text

You apply either of two types of automatic kerning: metrics kerning or optical kerning, or you can adjust the spacing between letters manually.

Use metrics kerning

1. Set the text insertion point between the characters you want to pair kern, or select text.
2. In the Character panel or Control panel, select Metrics in the Kerning  menu.
3. In the Character panel or Control panel, select Metrics or Metrics - Roman Only in the Kerning  menu.

Note: If Metrics is applied to fonts (including some Japanese OpenType fonts) which do not contain pair kerning information, spacing for each character will be set to “0” and character compression will not occur.

To avoid using the built-in kerning information of a font for selected text, choose “0” in the Kerning  menu.

Note: The default setting is Metrics – Roman Only. When Metrics - Roman Only is applied to Roman OpenType fonts, kerning is the same as when Metrics is selected. When Metrics - Roman Only is applied to CJK OpenType fonts, only the Roman characters will be kerned with kerning pairs as if Metrics were set. The CJK characters will not be kerned, as if '0' were set. For this reason, choose '0' to turn off pair kerning.

Note: If you use font metrics kerning in a Japanese OpenType font, it is recommended that you choose OpenType > Use Proportional Metrics from the Control panel menu. That way, you can avoid making unnecessary manual kerning adjustments.

Use optical kerning

1. Set the text insertion point between characters you want to pair kern or select the text you want to kern.
2. In the Character panel or Control panel, select Optical in the Kerning  menu.

Note: Optical Kerning is designed on the basis of Roman character forms. You can use this feature with CJK fonts, but you should always check the results of the operation.

Adjust kerning manually

1. Using the Type tool , click to place an insertion point between two characters.

Note: If a range of text is selected, you can't manually kern the text (you can choose only Metrics, Optical, or 0). Instead, use tracking.

Note: If a range of text is selected, you can't manually kern the text (you can choose only Metrics, Metrics - Roman Only, Optical, or 0). Instead, use tracking.

2. Do any of the following:

- In the Character panel or the Control panel, type or select a numeric value in the Kerning menu.
- Press Alt+Left/Right Arrow (Windows) or Option+Left/Right Arrow (Mac OS) to decrease or increase the kerning between two characters.

The amount of the word kerning adjustment is the same as the Kerning value in the Units & Increments Preferences dialog box. When you press the shortcut and hold down the Ctrl or Command key, the kerning amount is the Kerning preferences value multiplied by 5.

Change the default kerning increment value

- In the Units & Increments section of the Preferences dialog box, type a new value for the Kerning option and click OK.

Turn off kerning for selected text

1. Select text.
2. In the Character panel or Control panel, type or choose 0 in the Kerning menu.

You can also press Alt+Ctrl+Q (Windows) or Option+Command+Q (Mac OS) to reset kerning and tracking. When you do so, kerning is set to Metrics regardless of which kerning option was previously applied.

Adjust tracking

1. Select a range of characters.
2. In the Character panel or Control panel, type or select a numeric value for Tracking .

Highlight text containing custom kerning and tracking

In some instances, you'll want to be aware of text that has custom tracking and kerning applied. If you select the Custom Tracking/Kerning preferences option, green highlighting appears over text with custom tracking or kerning.

1. Choose Edit > Preferences > Composition (Windows) or InDesign > Preferences > Composition (Mac OS).
2. Select Custom Tracking/Kerning, and then click OK.

Adjust kerning between words

- With the Type tool , select a range of text and do one of the following:
 - To add space between selected words, press Alt+Ctrl+\ (Windows) or Option+Command+\ (Mac OS).
 - To remove space between selected words, press Alt+Ctrl+Backspace (Windows) or Option+Command+Delete (Mac OS).
 - To multiply the kerning adjustment by 5, hold down Shift as you press the keyboard shortcut.

Adobe also recommends

- [Keys for working with type](#)



Twitter™ and Facebook posts are not covered under the terms of Creative Commons.

[Legal Notices](#) | [Online Privacy Policy](#)

Formatting CJK characters

- [Apply shatai to text](#)
- [Rotate characters](#)
- [Adjust aki before and after characters](#)
- [Use tate-chu-yoko](#)
- [Add Ruby to text](#)
- [Apply kenten](#)
- [Align text of different sizes](#)

[To the top](#)

Apply shatai to text

In traditional typesetting technology, characters were slanted by using a lens to distort the glyphs when being set on film. This oblique style is known as *shatai*. Shatai is distinct from a simple slant of the glyphs, because it also scales the glyphs. You can adjust the magnification or angle of text you want to slant from the center point, without changing the height of the glyph, using the shatai feature in InDesign.

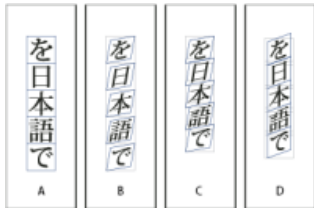

Shatai

A. No scale applied **B.** Magnification 30%, 45 shatai **C.** Selecting the Adjust Tsume option **D.** Selecting the Adjust Rotation option

1. Select text.
2. Select Shatai from the Character panel menu or Control panel menu.
3. Specify the following options, and click OK:
 - Specify the degree of skew in Magnification (In traditional typesetting technology terms, 10% magnification is lens 1, and 40% magnification is lens 4).
 - Set the angle of obliqueness to 30, 45, or 60, in Angle.
 - Select Adjust Rotation to rotate the glyphs, and display horizontal lines horizontally for horizontal text, and vertical lines vertically for vertical text.
 - Select Adjust Tsume to apply jidori.



 You can fine tune the rotated oblique effect for individual characters, after applying shatai to text.

[To the top](#)

Rotate characters

1. Select the characters.
2. In the Character panel, type a value for Character Rotation  Specify a minus value to rotate the character to the right (clockwise).

Adjust aki before and after characters

1. Select opening parenthesis or closing parenthesis with the type tool.
2. Choose the amount of aki you want to add from the Mojikumi Before Character  or Mojikumi After Character  pop-up menu, in the Character panel.

For example, if you specify 2bu, half a full-width space is added, and if you specify 4bu, a quarter of a full-width space is added. This aki will not be adjusted when the line is set to full justification. Adjusting aki is especially useful to override Mojikumi Akiryo Settings for certain characters.

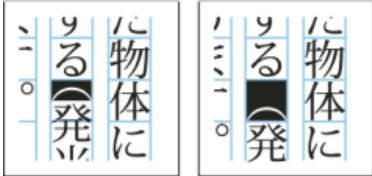

Adding aki before opening parenthesis

Use tate-chu-yoko

Using tate-chu-yoko (also known as kumimoji or renmoji) is an option to make a part of the text horizontal, in vertical text. It is easier to read half-width characters such as numbers, dates, and short foreign words in a vertical text frame, by rotating the text.

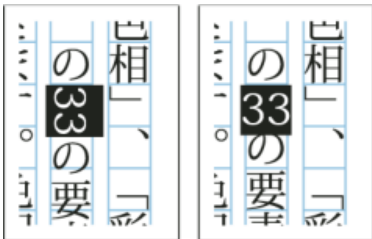

Before and after applying tate-chu-yoko

You can move text left, right, up, and down when you turn on the Tate-chu-yoko option. You can also set Auto Tate-chu-yoko for special half-width characters. Auto Tate-chu-yoko is set in the paragraph attributes.

 Use *tsume* or *tracking* in the Character panel to adjust the character spacing for Tate-chu-yoko.

Apply tate-chu-yoko

1. Select the text to which you want to apply tate-chu-yoko.
2. Do one of the following:
 - Choose Tate-chu-yoko from the Character panel menu or Control panel menu.
 - Choose Tate-chu-yoko Settings from the Character panel menu or Control panel menu, choose Tate-chu-yoko in the Tate-chu-yoko

dialog box, and click OK.

💡 If multiple instances of *tate-chu-yoko* appear next to each other, use the *Non-joiner* character to keep them separate. Choose *Type > Insert Special Character > Other > Non-joiner*.

Remove *tate-chu-yoko*

1. Select the text to which you want to apply *tate-chu-yoko*.
2. Do one of the following:
 - Choose and cancel *Tate-chu-yoko* from the *Character* panel menu or *Control* panel menu.
 - Choose *Tate-chu-yoko Settings* from the *Character* panel menu, deselect *Tate-chu-yoko* in the *Tate-chu-yoko* dialog box, and then click OK.

Change *tate-chu-yoko* settings

1. Choose *Tate-chu-yoko Settings* from the *Character* panel menu.
2. Specify a value for moving the text up or down in *X Offset*. If you specify a plus value, the text will move up, and if you specify a minus value, it will move down.
3. Specify a value for moving the text left or right in *Y Offset*. If you specify a plus value, the text will move to the right, and if you specify a minus value, it will move to the left.

Set Auto *Tate-chu-yoko* for specific paragraphs

1. Select the text to be set to *Auto Tate-chu-yoko*, or place the text insertion point in the paragraph.
2. Choose *Auto Tate-chu-yoko* from the *Paragraph* panel menu.
3. In *KumiNumber*, specify the number of successive half-width characters that you want to rotate to vertical orientation. For example, if this is set to 2, the character string "123" will not rotate, while "12" will.
4. If you want to apply *tate-chu-yoko* to roman text, select *Include Roman Characters*, and click OK.

[To the top](#)

Add Ruby to text

In Japanese, Ruby (also known as *furigana*) is normally used to show the kanji yomi in hiragana. In Simplified Chinese, Ruby is called Pinyin, while in Traditional Chinese, Ruby is called Chuyin. InDesign provides full support to Japanese Ruby and limited support to Chinese Pinyin or Chuyin. You can adjust Ruby settings to specify Ruby location, size, or color. Furthermore, when the ruby is longer than the parent you can specify the ruby distribution. You can also apply *tate-chu-yoko* to Ruby.



Ruby on horizontal text (left), and ruby to the right of vertical text (right)

When the parent to which you want to attach ruby covers two lines, the ruby will follow when the parent moves to the next line.

Note: In some instances, such as when applying a style that includes a variable, Ruby characters may be removed.

1. Select the text to which you want to attach ruby. You cannot attach ruby when there are forced line breaks in the selected text.
2. Select Ruby > Ruby from the Character panel menu or Control panel menu.
3. Enter the ruby characters in Ruby.
4. Change Ruby settings by clicking an option on the left side of the dialog box and specifying settings.
5. Click OK.

Ruby settings

The following options appear in the different panels of the Ruby dialog box.

Ruby Placement and Spacing

- From the Type menu, choose Per-Character or Group Ruby. When Per Character Ruby is selected, enter a half or full width space when inputting Ruby characters to separate them in line with their parent characters. For "hakunetsutou" for example, enter as "haku netsu tou" (example of a word composed of Japanese characters and its phonetic spelling is given).

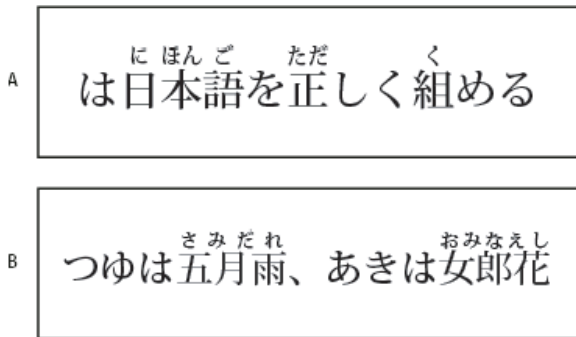

Ruby

- From the Alignment menu, specify the position of the Ruby characters. You can check the position with the graphic shown in the sample field.
- To attach ruby above horizontal text or to the right of vertical text, select Above/Right, and to attach below horizontal text or to the left of vertical text, select Below/Left in Placement.
- Specify the spacing between the ruby and the parent in XOffset and YOffset. When you enter a minus value, the ruby moves closer to the parent.

Ruby Font and Size

- Select a font family and font style in Font.
- Specify the size of the ruby characters in Size. The default ruby size is half the size of the parent.
- Specify the scale for the height and width of the ruby characters in Horizontal Scale and Vertical Scale.
- Select Use Open Type Pro Ruby Glyphs to use alternate glyphs for ruby (when possible). Specific kana characters are available for some Open Type Pro fonts. When you select this option, the specific font for ruby characters, and not the standard kana font, will be used.

- In KumiNumber, specify the number of successive half-width characters that you want to rotate to vertical orientation. For example, if this is set to 2, the character string "123" will not rotate, while "12" will.
- Select Include Roman Characters to apply tate-chu-yoko to roman text.
- Select Scale to Fit to force the tate-chu-yoko to have the same dimensions (1 em x 1 em) in the ruby string, either using an OpenType feature or scaling the glyphs.

Adjustment When Ruby Is Longer Than Parent

- With Overhang, when the total Ruby width is greater than that of their parent characters, the specified Ruby will overflow widthways into the space above characters either side of the parents. For Japanese, character types compatible with Overhang comply with the JISx4051-1995 specification.
- Specify the parent character spacing necessary for attaching ruby in Spacing. When you select a different option, the graphics displayed in the sample field are updated.
- To automatically adjust the ruby character width, select Char Width Scaling, and specify the compression scale for the width of the ruby characters.
- Select Auto Align at Line Edges to align the parent with the start and end of the line.

Ruby Color

- Select a color swatch in the list box.
- Specify the degree of tinting and line weight, as necessary.
- Select Overprint Fill or Overprint Stroke to set filling or stroke overprint for ruby characters.

(See Determining when to overprint manually.)

[To the top](#)

Apply kenten

Kenten (also known as *Boten*) are points which you attach to text you want to highlight. You can select the type of points from existing kenten forms, or specify customized kenten characters. You can also specify the position, scale, and color by adjusting the kenten settings.

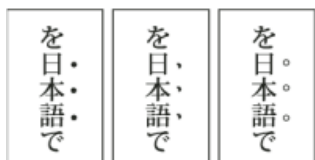

Small black circle kenten, black sesame kenten, and small white circle kenten applied to text

Apply kenten

1. Choose the characters you want to highlight.
2. Choose a kenten character, such as Fisheye or White Circle, from Kenten in the Character panel menu or Control panel menu.

Change kenten settings and color

1. Choose Kenten > Kenten from the Character panel menu or Control panel menu.

2. For Kanten Settings, specify the options below:

Kanten Type Select a kanten character, such as Fisheye or White Circle. Choose Custom to specify a custom character. You can enter characters directly, or you can specify a character code value for the specified character set.

Position Specify the spacing between the kanten and characters.

Location Select Above/Right to attach kanten above horizontal text or to the right of vertical text, and Below/Left to attach below horizontal text or to the left of vertical text.

Size Specify the size of the kanten character.

Align Specify whether the kanten should be displayed in the center (Center) or to the left (Left) (above for vertical text) of the character's embox.

H/Scale and V/Scale Specify the scale for the height and width of the kanten character.

3. To change the color of the kanten, choose Kanten Color from the list box, and then specify the options below:

- Select a color swatch from the list box.
- Specify the degree of tinting and line weight, as necessary.
- Select Overprint Fill or Overprint Stroke to set filling or stroke overprint for kanten characters.
(See Determining when to overprint manually.)

4. Click OK.

[To the top](#)

Align text of different sizes

You can specify how to align text to the largest characters in a line using the Character Alignment option, when positioning characters of different sizes in 1 line. It is possible to align characters to the top, center or bottom of the embox (right, center, and left for vertical frames), to the roman baseline, and to the top or bottom of the ICF box (right or left for vertical frames). *ICF* (Ideographic Character Face) is the average height and width used by the font designer to design the ideographic characters which comprise a font.



Align different sizes

A. Align different size letters above full space letters **B.** Align different size letters in the middle of full space letters **C.** Align different size letters below full space letters

Note: The Character Alignment option is not effective, even if applied, when all characters are the same size in a line.

1. Select a range of text or lines for the characters you want to align, or select a text frame using the selection tool.
2. Choose one of the following options from Character Alignment in the Character panel menu or Control panel menu.

- Roman Baseline aligns the small characters in a line to the large character baseline grid.
- Embox Top/Right, Center, or Embox Bottom/Left align the small characters in a line to the specified position of the large characters embox. In vertical text frames, Embox Top/Right aligns the text to the right of the embox, and Embox Bottom/Left aligns the paragraph to the left of the embox.
- ICF Top/Right and ICF Bottom/Left align the small characters in a line to the ICF specified by the large characters. In vertical text frames, ICF Top/Right aligns the text to the right of the ICF, and ICF Bottom/Left to the left of the ICF.

Adobe also recommends

 Twitter™ and Facebook posts are not covered under the terms of Creative Commons.

[Legal Notices](#) | [Online Privacy Policy](#)

Arabic and Hebrew features | CC, CS6

[Adobe World-Ready Composers](#)

[Text direction](#)

[Story direction](#)

[Automatic Kashida insertion](#)

[Ligatures](#)

[Diacritical marks](#)

[Copy-paste from Microsoft Word](#)

[Default fonts](#)

[Legacy font support](#)

[Digit Types](#)

[Hyphenation](#)

[Find and replace](#)

[Glyphs](#)

[Justification Alternates](#)

[Special Middle East characters insertion](#)

[Table direction](#)

[Binding directions](#)

[Right to Left writing preferences](#)

[Page and chapter numbering](#)

[Writing direction in Gallery view and Story Editor](#)

[Diacritical coloring](#)

New and improved features for working in Arabic and Hebrew are available in the Middle East and North African edition of this software.

[To the top](#)

Adobe World-Ready Composers

Adobe World-Ready composers enable you to create content in middle-eastern languages. You can type in, and mix between, Arabic, Hebrew, English, French, German, Russian, and other Latin languages.

You can choose between available composers from the Paragraph panel menu (Windows > Paragraph > panel menu). For example, in InDesign, you can use the Adobe World-Ready Paragraph Composer. Or, in Illustrator, you can use the Middle Eastern Single-line Composer.

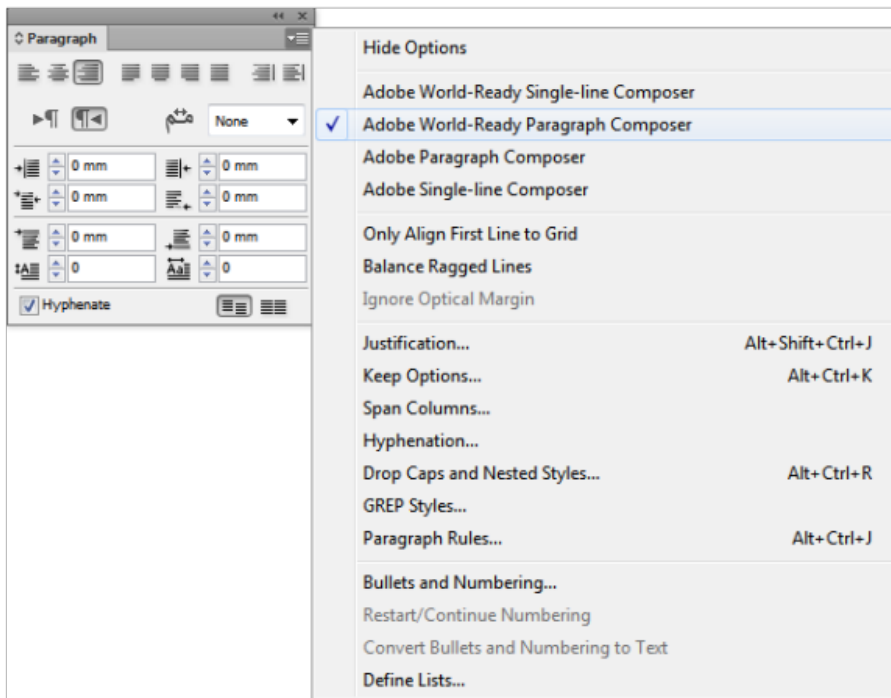

Adobe World-Ready Composers

You can also save your files with Arabic and Hebrew names.

[To the top](#)

Text direction

To create content in Arabic and Hebrew, you can make the right-to-left (RTL) direction the default text direction. However, for documents that include left-to-right (LTR) text, you can now seamlessly switch between the two directions.

Select the paragraph direction from the Paragraph panel.

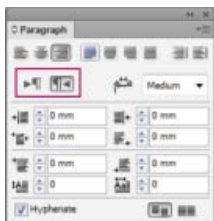

Paragraph direction selection

If you have a mix of languages in the same paragraph, you can specify the direction of text at a character level. Also, to insert dates or numbers, specify the direction of text at the character level.

From the Character panel menu, choose Character Direction and then select a direction.

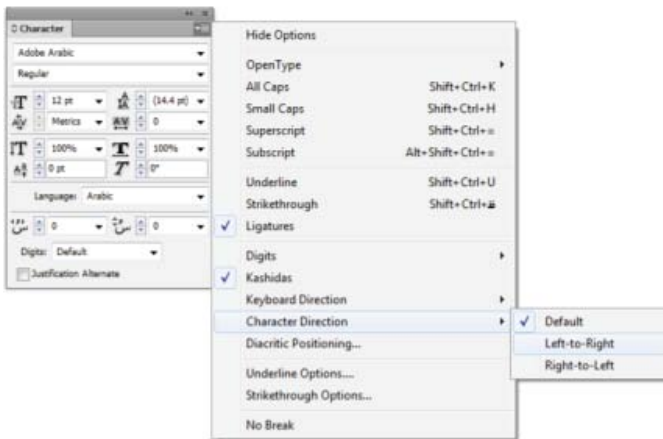

Character direction

[To the top](#)

Story direction

When you're working with Arabic and Hebrew languages, the story generally flows from the right to the left. The first column must be on right side of the frame, and subsequent columns are added to the left. If your layout contains mixed content, then different stories need a different direction.

From the Story panel (Window > Type & Tables > Story), click a story direction.



Story direction

[To the top](#)

Automatic Kashida insertion

In Arabic, text is justified by adding Kashidas. Kashidas are added to arabic characters to lengthen them. Whitespace is not modified. Use automatic Kashida insertion to justify paragraphs of arabic text.

Select the paragraph and from the Paragraph panel (Window > Type & Tables > Paragraph), choose a setting from the Insert Kashida drop-down list. The options available are: None, Short, Medium, Long, or Stylistic. Kashidas are only inserted if the paragraph is justified. This setting is not applicable for paragraphs that have alignment settings.

To apply Kashidas to a group of characters, select the characters and choose Kashidas from the Character panel menu.

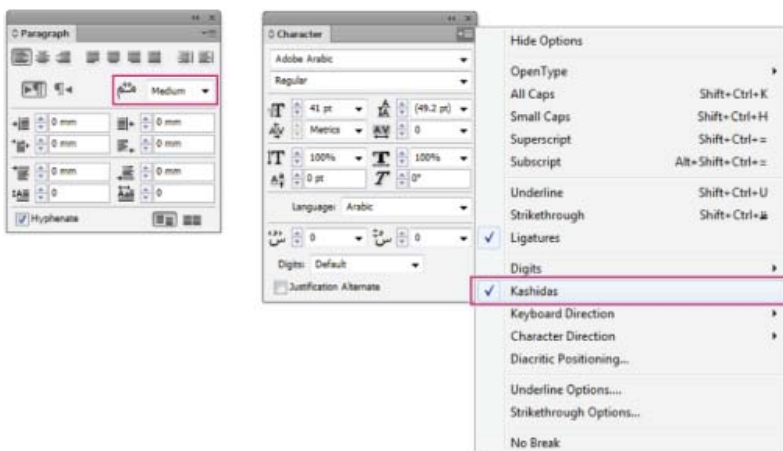

Ligatures

You can automatically apply ligatures to character pairs in Arabic and Hebrew. Ligatures are typographic replacement characters for certain letter pairs if they are available in a given Open Type font.

When you choose Ligatures from the Character panel menu or Control panel menu, a standard ligature defined in the font is produced.

1. Select text.
2. Choose Ligatures from the Character panel menu or the Control panel menu.

However, some Open Type fonts include more ornate, optional ligatures, which can be produced when you choose Discretionary Ligatures. These ligatures are found at Character panel > OpenType > Discretionary Ligatures.

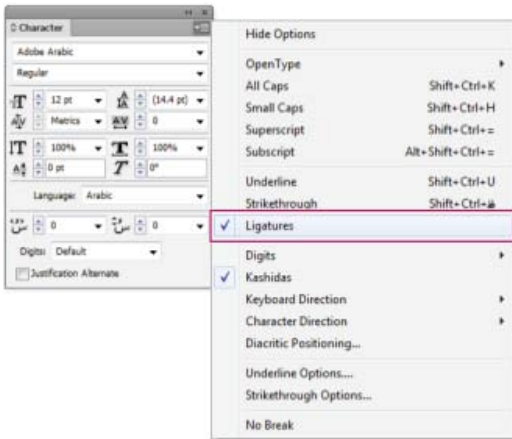

Enable automatic ligatures

Diacritical marks

In the Arabic script, a diacritic or a diacritical mark is a glyph used to indicate consonant length or short vowels. A diacritical mark is placed above or below the script. For better styling of text, or improved readability of certain fonts, you can control the vertical or horizontal position of diacritical marks:

1. Select text that has diacritical marks
2. In the Character panel, modify the position of the diacritic marks relative to the script. Values you can change are, Adjust Horizontal Diacritic Position, and the Adjust Vertical Diacritic Position.

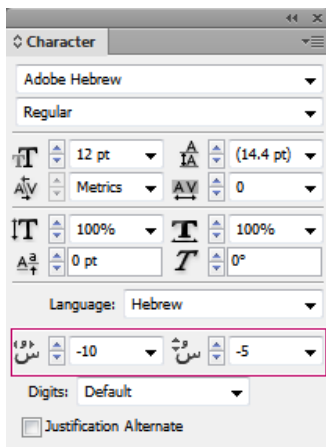

Change the position of diacritical marks

[To the top](#)

Copy-paste from Microsoft Word

You can copy text from Microsoft Word, and paste it directly into a document. The pasted text's alignment and direction is automatically set to that of the arabic or hebrew text.

[To the top](#)

Default fonts

When you install a Middle Eastern or North African version, the default typing font is set to the installation-specific language, by default. For example, if you have installed the English/Arabic-enabled version, the default typing font is set to Adobe Arabic. Similarly, if you have installed the English/Hebrew-enabled version, the default typing font is set to Adobe Hebrew (or Myriad Hebrew in Photoshop).

[To the top](#)

Legacy font support

Fonts that have been traditionally used (for example, AXT fonts) can continue to be used in this release of the software. However, it is recommended that newer Open Type fonts be used for text-based elements.

Missing Glyph Protection (Edit > Preferences > Advanced Type) is enabled by default. Text is handled automatically, where glyphs are not available in the font you are using.

[To the top](#)

Digit Types

When you are working in Arabic or Hebrew, you can select the type of digits you want to use. You can choose between Arabic, Hindi, and Farsi. By default, in Arabic, the Hindi version is auto-selected, and in case of Hebrew, the Arabic type digits are selected. However, you can switch to Arabic digits, if necessary:

1. Select the digits in the text typed.
2. In the Character panel (Ctrl + T), use the Digits list to select the font that the digits must appear in.

You can ensure that Arabic digits are used by enabling the Use Native Digits when typing in Arabic Scripts option. To use this option, choose Edit > Preferences > Advanced Type.

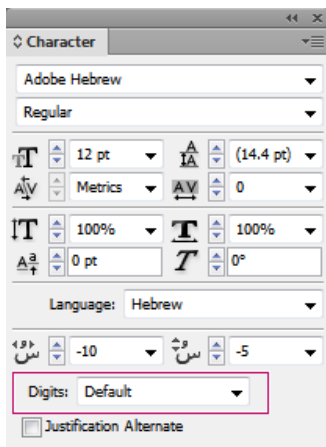

Digit type selection

[To the top](#)

Hyphenation

Sentences that have more words that can fit into one line of text automatically wrap into the next line. The type of text justification when wrapping occurs sometimes causes unnecessary spaces to appear in the line that are not aesthetically pleasing or linguistically correct. Hyphenation enables you to split the word at the end of a line, using a hyphen. This fragmentation causes the sentence to wrap into the next line in a better way.

Mixed text: The Kashida insertion feature affects how hyphenation occurs in mixed text. When enabled, Kashidas are inserted where applicable, and non-Arabic text is not hyphenated. When the Kashida feature is disabled, only non-Arabic text is considered for hyphenation.

Hebrew text: Hyphenation is allowed. To enable hyphenation and customize settings, choose Paragraph panel > Panel menu > Hyphenation Settings.

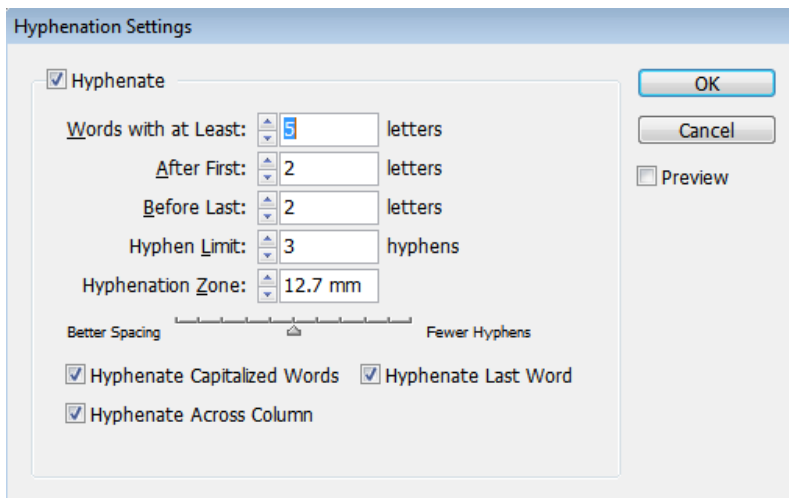

Hyphenation options

[To the top](#)

Find and replace

Arabic and Hebrew users can perform full text search and replace. In addition to searching and replacing simple text, you can also search and replace text with specific characteristics. These characteristics can include diacritical marks, Kashidas, special characters (for example, Alef), digits in different languages (for example, digits in Hindi), and more.

To perform text find-and-replace:

- **InDesign:** Edit > Find/Change

In InDesign, you can use the Transliterate tab (Edit > Find/Change) to find and replace digits between Arabic, Hindi, and Farsi. For example, you can find digits typed in Hindi and convert them to Arabic.

[To the top](#)

Glyphs

Arabic and Hebrew users can apply glyphs from the default character set. However, to browse, select, and apply a glyph from the default character set or a different language set, use the Glyphs panel:

- **InDesign:** Window > Type & Tables > Glyphs
- **Illustrator:** Window > Type > Glyphs

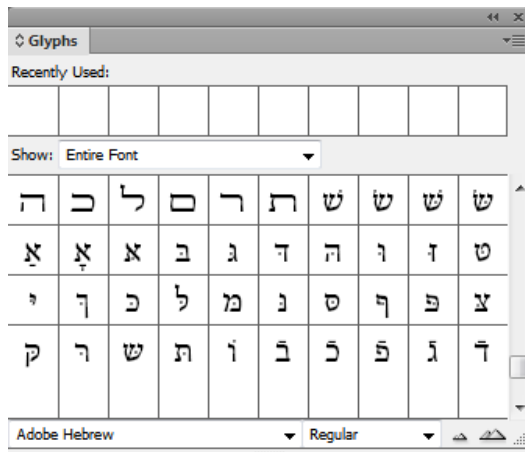

Browse, select, and apply glyphs

[To the top](#)

Justification Alternates

A font can have alternative shapes of certain letters of the alphabet. These variations of the font face for some letters are generally available for stylistic or calligraphy purposes. In rare cases, justification alternates are used to justify and align paragraphs for specific needs.

Justification alternates can be turned on at a paragraph level, where alternates are used wherever possible. You can also turn on or off this feature at a character level. Justification alternates are available only in those fonts that have this feature integrated. Therefore, the option to turn them on or off is available only for supported fonts.

Arabic fonts that contain justification alternates: Adobe Arabic, Myriad Arabic, and Adobe Naskh. Hebrew fonts that contain justification alternates: Adobe Hebrew and Myriad Hebrew.

- **InDesign**

Paragraph-level: Window > Paragraph panel > panel menu > Justification, and then choose an option from the Justification list.

Character-level: Window > Character panel > panel menu > Justification Alternate option.

- **Photoshop**

Character-level: Window > Character panel > Justification Alternates checkbox.

[To the top](#)

Special Middle East characters insertion

Some characters in Arabic and Hebrew are difficult to insert in text. Also, Arabic and Hebrew keyboard layouts make it difficult to type or include these characters. To insert characters like a Hebrew apostrophe (Geresh) or Maqaf, select a character from Character panel > panel menu >

Insert Special ME Character.

Insert Special Character	▶	
Insert Special ME Character	▶	Geresh
Insert White Space	▶	Gershayim
Insert Break Character	▶	Maqaf
Fill with Placeholder Text		Sof Pasuk
Tag Text	▶	Kashida
Autotag	Alt+Shift+Ctrl+F7	Dotted Circle
Interactive	▶	Left to Right Dash
Edit in Story Editor	Ctrl+Y	Right to Left Dash
InCopy	▶	Unicode Markers ▶

Insert a special ME character

[To the top](#)

Table direction

Arabic and Hebrew users can set the direction of a table inserted in a document. Accordingly the order of cells and columns, default language, and the alignment of text is set. For an Arabic user, the rightmost column is the first column, and any additional columns are added beyond the leftmost column of the table. Table direction is also supported in the Story Editor (Ctrl + Y).

To set the direction of a new table:

1. Click Table > Insert Table
2. In the Insert Table dialog box, choose from the Direction list to select the table direction.

To change the direction of an existing table:

1. Place the cursor inside a table
2. Open the Table panel (Shift + F9), and click the Left-to-Right Table or Right-to-Left Table icons to set the direction of the table.

For Right-to-Left tables, the Arabic and North African versions default to Arabic language. The Hebrew version is set to Hebrew language. For Left-to-Right tables, the Arabic and Hebrew versions default to English language. The North African version defaults to French.

[To the top](#)

Binding directions

Binding direction determines the edge along which a book is bound. Books written in a left-to-right language are left-bound. Documents written in right-to-left language are bound along the rightmost edge of the book.

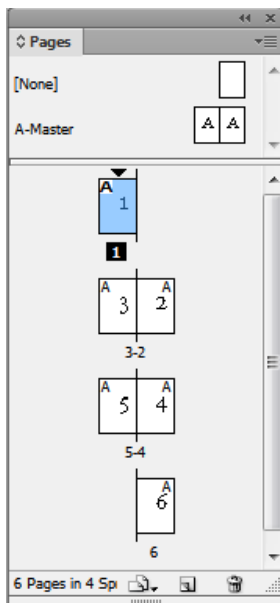

Page layout of a right-bound book

[To the top](#)

Right to Left writing preferences

Neutral characters

The direction of some characters in Arabic and Hebrew can appear ambiguous. Lack of clarity about the direction of characters can cause confusion in the direction and order of strings. To ensure that the direction of such characters is clear and unambiguous:

1. Click Edit > Preferences > Right to Left
2. Select the Force Neutral Character Direction According to the Keyboard Input box.

Cursor Control

Arabic and Hebrew users can control the direction that the cursor moves, when they use the arrow keys on the keyboard. This Cursor Movement list (Edit > Preferences > Right to Left) has two options that you can choose from:

- **Visual:** The cursor moves in the direction of the arrow key. When the right arrow is pressed, the cursor on the screen moves to the right.
- **Logical:** The cursor moves according to the direction of the language typed. In Arabic and Hebrew, when the right arrow is pressed, the cursor moves left (to the next character in a right to left language).

[To the top](#)

Page and chapter numbering

Arabic and Hebrew users use the most commonly preferred numbering systems in the region. The most popular numbering systems are:

- **Arabic:** Arabic Abjad and Alef-Ba-Tah
- **French:** Hebrew Biblical Standard and Hebrew Non-Standard Decimal

To select or change the numbering system, go to Layout > Numbering & Section Options, and then select from the Style list.

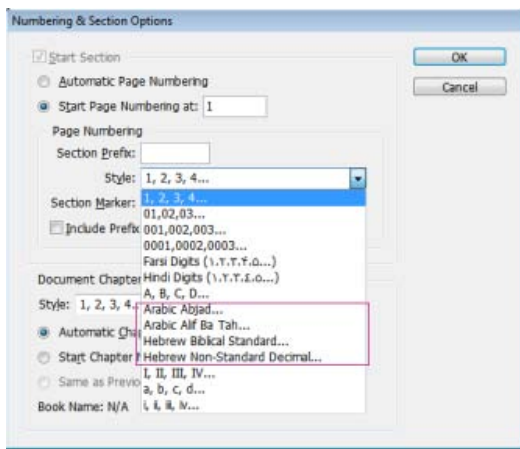

Numbering pages, sections, and chapters

[To the top](#)

Writing direction in Gallery view and Story Editor

While in Arabic or Hebrew, you can indicate the direction in which you are writing. Go to Edit > Preferences > Story Editor Display, and select the Indicate Writing Direction box, to enable this feature. When this feature is enabled, the cursor has an arrow that indicates the direction of writing.

[To the top](#)

Diacritical coloring

In Arabic text, diacritical marks can be colored differently for stylistic or other purposes. For example, diacritical marks can be lay emphasis on a particular aspect of a word or sentence. You can find and change the color of diacritical marks using the Change Arabic Diacritic Color query.

1. Click Edit > Find/Change
2. From the Query list, select Change Arabic Diacritic Color
3. Use the Change, Change All, or Change/Find buttons to replace older diacritical marks with the new colored diacritical marks.

You can modify and save the query as per your requirements.

 Twitter™ and Facebook posts are not covered under the terms of Creative Commons.

[Legal Notices](#) | [Online Privacy Policy](#)

Tables

Table and cell styles

- [About table and cell styles](#)
- [Table/Cell Styles panels overview](#)
- [Define table and cell styles](#)
- [Load \(import\) table styles from other documents](#)
- [Apply table and cell styles](#)
- [Base one table or cell style on another](#)
- [Edit table and cell styles](#)
- [Delete table and cell styles](#)
- [Redefine table or cell styles based on current formatting](#)
- [Override table and cell styles](#)
- [Break the link to table or cell styles](#)

[To the top](#)

About table and cell styles

Just as you use text styles to format text, you can use table and cell styles to format tables. A *table style* is a collection of table formatting attributes, such as table borders and row and column strokes, that can be applied in a single step. A *cell style* includes formatting such as cell insets, paragraph styles, and strokes and fills. When you edit a style, all tables or cells to which the style is applied are updated automatically.

Note: *There is one important difference between text styles and table styles. While all character styles attributes can be part of a paragraph style, cell style attributes are not part of the table style. For example, you cannot use a table style to change the border color of interior cells. Instead, create a cell style and include it in the table style.*

[Basic Table] and [None] styles

By default, each new document contains a [Basic Table] style that can be applied to tables you create and a [None] style that can be used to remove cell styles applied to cells. You can edit the [Basic Table] style, but you can't rename or delete either [Basic Table] or [None].

Using cell styles in table styles

When you create a table style, you can specify which cell styles are applied to different regions of the table: header and footer rows, left and right columns, and body rows. For example, for the header row, you can assign a cell style that applies a paragraph style, and for the left and right columns, you can assign different cell styles that apply shaded backgrounds.

Name	Region and City	Member Since
Lee	East, Taipei	June 1999
Luebke	East, Augsburg	November 2003
Sanchez	South, Fort Morrison	August 1998
Stewart	North, Suddan	May 2001
Rhoades	West, Tucson	March 2004

Cell styles applied to regions in table style

A. Header row formatted with cell style that includes paragraph style B. Left column C. Body cells D. Right column

Cell style attributes

Cell styles do not necessarily include all the formatting attributes of a selected cell. When you create a cell style, you can determine which attributes are included. That way, applying the cell style changes only the desired attributes, such as cell fill color, and ignores all other cell attributes.

Formatting precedence in styles

If a conflict occurs in formatting applied to a table cell, the following order of precedence determines which formatting is used:

Cell style precedence 1. Header/Footer 2. Left column/Right column 3. Body rows. For example, if a cell appears in both the header and the left column, the formatting from the header cell style is used.

Table style precedence 1. Cell overrides 2. Cell style 3. Cell styles applied from a table style 4. Table overrides 5. Table styles. For example, if you apply one fill using the Cell Options dialog box and another fill using the cell style, the fill from the Cell Options dialog box is used.

[To the top](#)

Table/Cell Styles panels overview

Use the Table Styles panel (Window > Styles > Table Styles) to create and name table styles, and to apply the styles to existing tables or tables you create or import. Use the Cell Styles panel (Window > Styles > Cell Styles) to create and name cell styles, and to apply the styles to table cells. Styles are saved with a document and appear in the panel each time you open that document. You can save table and cell styles in groups for easier management.

When you position the insertion point in a cell or table, any style that is applied is highlighted in either of the panels. The name of any cell style that is applied through a table style appears in the lower left corner of the Cell Styles area. If you select a range of cells that contains multiple styles, no style is highlighted and the Cell Styles panel displays "(Mixed)."

Open the Table Styles or Cell Styles panel

- Choose Window > Styles, and choose Table Styles or Cell Styles.

Change how styles are listed in the panel

- Select Small Panel Rows to display a condensed version of the styles.
- Drag the style to a different position. You can also drag styles to groups that you create.
- Choose Sort By Name from the panel menu to list the styles alphabetically.

[To the top](#)

Define table and cell styles

1. If you want to base a new style on the formatting of an existing table or cell, place the insertion point in a cell.
2. If desired, define a paragraph style for the cell style.
3. Choose Window > Styles > Table Styles to open the Table Style panel, or choose Window > Styles > Cell Styles to open the Cell Styles panel.
4. Choose New Table Style from the Table Styles panel menu, or choose New Cell Style from the Cell Styles panel menu.
5. For Style Name, type a name.

6. For Based On, select which style the current style is based on.
7. To define a style shortcut, position the insertion point in the Shortcut text box and make sure that Num Lock is on. Then hold down any combination of Shift, Alt, or Ctrl (Windows) or Shift, Option, and Command (Mac OS), and press a number on the numeric keypad. You cannot use letters or non-keypad numbers for defining style shortcuts.
8. To specify the formatting attributes, click a category on the left and specify the attributes you want. For example, to assign a paragraph style to a cell style, click the General category, and then choose the paragraph style from the Paragraph Style menu.

For cell styles, options that don't have a setting specified are ignored in the style. If you don't want a setting to be part of the style, choose (Ignore) from the setting's menu, delete the contents of the field, or click a check box until a small box appears in Windows or a hyphen (-) appears in Mac OS.

9. If you want the new style to appear in a style group you've created, drag it to the style group folder.

[To the top](#)

Load (import) table styles from other documents

You can import table and cell styles from another InDesign document into the active document. During import, you can determine which styles are loaded and what should occur if a loaded style has the same name as a style in the current document. You can also import styles from an InCopy document.

1. From the menu of the Cell Styles or Table Styles panel, choose Load Cell Styles, Load Table Styles, or Load Table And Cell Styles.
2. Double-click the InDesign document containing the styles you want to import.
3. In the Load Styles dialog box, make sure that a check mark appears next to the styles you want to import. If any existing style has the same name as one of the imported styles, choose one of the following options under Conflict With Existing Style, and then click OK:

Use Incoming Style Definition Overwrites the existing style with the loaded style and applies its new attributes to all cells in the current document that used the old style. The definitions of the incoming and existing styles appear at the bottom of the Load Styles dialog box so you can compare them.

Auto-Rename Renames the loaded style. For example, if both documents have a style named "Table Style 1," the loaded style is renamed "Table Style 1 copy" in the current document.

[To the top](#)

Apply table and cell styles

Unlike paragraph and character styles, table and cell styles do not share attributes, so applying a table style does not override cell formatting, and applying a cell style does not override table formatting. By default, applying a cell style removes formatting applied by any previous cell style, but does not remove local cell formatting. Similarly, applying a table style removes formatting applied by any previous table style, but does not remove overrides made using the Table Options dialog box.

In the Styles panel, a plus sign (+) appears next to the current cell or table style if the selected cell or table has additional formatting that isn't part of the applied style. Such additional formatting is called an *override*.

1. Position the insertion point in a table, or select the cells to which you want to apply the style.
2. Do one of the following:

Click the table or cell style in the Table Styles or Cell Styles panel (choose Window > Styles > Table Styles or Cell Styles). If the style is in a style group, expand the style group to locate the style.

- Press the shortcut you defined for the style. (Make sure that Num Lock is on.)

[To the top](#)

Base one table or cell style on another

You can create links between similar table or cell styles by creating a base, or *parent*, style. When you edit the parent style, any changed attribute that appears in the *child* styles will change as well. By default, table styles are based on [No Table Style], and cell styles are based on [None].

1. Create a new style.
2. In the New Table Style or New Cell Style dialog box, select the parent style in the Based On menu. The new style becomes the child style.
3. Specify formatting for the new style to distinguish it from the parent style.

[To the top](#)

Edit table and cell styles

One of the advantages of using styles is that when you change the definition of a style, all of the tables or cells formatted with that style change to match the new style definition.

1. Do one of the following:
 - If you don't want the style to be applied to a selected table or cell, right-click (Windows) or Control-click (Mac OS) the style in the Styles panel, and choose Edit *[style name]*.
 - In the Styles panel, double-click the style, or select the style and choose Style Options from the Styles panel menu. Note that this method applies the cell style to any selected cell or the table style to any selected table. If no table is selected, double-clicking a table style sets it as the default style for any table you create.
2. Adjust settings in the dialog box, and then click OK.

[To the top](#)

Delete table and cell styles

When you delete a style, you can select a different style to replace it, and you can choose whether to preserve the formatting.

1. Select the style in the Styles panel.
2. Do one of the following:
 - Choose Delete Style from the panel menu.
 - Click the Delete icon  at the bottom of the panel, or drag the style to the Delete icon.
 - Right-click (Windows) or Control-click (Mac OS) the style, and then choose Delete Style. This method is especially useful for deleting a style without applying it to the selected cell or table.
3. Select the style to replace it.

If you select [No Table Style] to replace a table style or [None] to replace a cell style, select Preserve Formatting to keep the formatting of the table or cell to which the style is applied. The table or cell preserves its formatting but is no longer associated with a style.

4. Click OK.

[To the top](#)

Redefine table or cell styles based on current formatting

After you apply a style, you can override any of its settings. If you decide you like the changes, you can redefine the style to retain the new formatting.

1. Place the insertion point in the table or cell that is formatted with the style you want to redefine.
2. Make changes to the table or cell as necessary.
3. Choose Redefine Style from the Styles panel menu.

Note: For cell styles, changes to only those attributes that are part of the cell style will enable the Redefine Style command. For example, if the cell style includes a red fill and you override a cell to use a blue fill, you can redefine the style based on that cell. But if you change an attribute that is ignored in the cell style, you can't redefine the style with that attribute.

[To the top](#)

Override table and cell styles

After you apply a table or cell style, you can override any of its settings. To override a table style, you can change options in the Table Options dialog box. To override a cell, you can change options in the Cell Options dialog box or use other panels to change the stroke or fill. If you select a table or cell that has an override, a plus sign (+) appears next to the style in the Styles panel.

You can clear table and cell overrides when you apply a style. You can also clear overrides from a table or cell to which a style has already been applied.

 If a style has a plus sign (+) next to it, hover over the style to view a description of the override attributes.

Preserve or remove overrides while applying a table style

- To apply a table style and preserve cell styles but remove overrides, hold down Alt (Windows) or Option (Mac OS) as you click the style in the Table Styles panel.
- To apply a table style and remove both cell styles and overrides, hold down Alt+Shift (Windows) or Option+Shift (Mac OS) as you click the style in the Table Styles panel.

 Right-click (Windows) or Control-click (Mac OS) the style in the Table Styles panel, and then choose Apply [table style], Clear Cell Styles to apply a style and clear cell styles.

Remove overrides while applying a cell style

- To apply a cell style and remove overrides, hold down Alt (Windows) or Option (Mac OS) as you click the name of the style in the Cell Styles panel.

Note: Only those attributes that are part of the cell style are considered overrides. For example, if the cell style includes a red fill and all other attributes are ignored, changing a different cell option is not considered an override.

Clear attributes not defined by a cell style

- Choose Clear Attributes Not Defined By Style from the Cell Styles panel menu.

Clear table or cell overrides

1. Select the table or cells containing the overrides.
2. In the Styles panel, click the Clear Overrides In Selection icon , or choose Clear Overrides from the Styles panel menu.

[To the top](#)

Break the link to table or cell styles

When you break the link between tables or cells and the style applied to them, the tables or cells retain their current formatting. However, future changes to that style won't affect them.

1. Select the cells to which the style has been applied.
2. Choose Break Link To Style from the Styles panel menu.

Adobe also recommends



Twitter™ and Facebook posts are not covered under the terms of Creative Commons.

[Legal Notices](#) | [Online Privacy Policy](#)

Formatting tables

Formatting tables

Resize columns, rows, and tables

Change the spacing before or after a table

Break tables across frames

Add text before a table

Format text within a table

Merge and split cells

Work with overset cells

[To the top](#)

Formatting tables

Use the Control panel or Character panel to format text within a table—just like formatting text outside a table. In addition, two main dialog boxes help you format the table itself: Table Options and Cell Options. Use these dialog boxes to change the number of rows and columns, to change the appearance of the table border and fill, to determine the spacing above and below the table, to edit header and footer rows, and to add other table formatting.

Use the Table panel, the Control panel, or the context menu to format the table structure. Select one or more cells and then right-click (Windows) or Control-click (Mac OS) to display a context menu with table options.

[To the top](#)

Resize columns, rows, and tables

You can resize columns, rows, and tables using a number of different methods.

Resize columns and rows

1. Select cells in the columns and rows you want to resize.
2. Do one of the following:
 - In the Table panel, specify Column Width and Row Height settings.
 - Choose Table > Cell Options > Rows And Columns, specify Row Height and Column Width options, and then click OK.

Note: *If you select At Least to set a minimum row height, rows increase in height as you add text or increase the point size. If you select Exactly to set a fixed row height, the row height does not change when you add or remove text. A fixed row height often results in an overset condition in the cell. (See [Work with overset cells.](#))*

- Position the pointer over the edge of a column or row so that a double-arrow icon () appears, and then drag left or right to increase or decrease the column width, or drag up or down to increase or decrease row height.

Name	Lee	
	Luebke	
	Sanchez	
	Stewart	
	Rhoades	

Name	Lee	
	Luebke	
	Sanchez	
	Stewart	
	Rhoades	

Before and after dragging to resize rows

By default, row height is determined by the slug height of the current font. Thus, row height also changes if you change the point size of type for entire rows of text, or if you change the row height setting. The maximum row height is determined by the Maximum setting in the Rows And Columns section of the Cell Options dialog box.

Resize rows or columns without changing the table width

- Hold down Shift while dragging an inside row or column edge (not the table boundary). One row or column gets bigger as the other gets smaller.
- To resize rows or columns proportionally, hold down Shift while dragging the right table border or bottom table edge.

Holding down Shift while dragging the right table edge will resize all the columns proportionally; holding down Shift while dragging the bottom table edge will resize all rows proportionally.

Resize the entire table

- Using the Type tool **T**, position the pointer over the lower-right corner of the table so that the pointer becomes an arrow shape , and then drag to increase or decrease the table size. Hold down Shift to maintain the table's height and width proportions.

Note: If the table spans more than one frame in a story, you cannot use the pointer to resize the entire table.

Distribute columns and rows evenly

1. Select cells in the columns or rows that should be the same width or height.
2. Choose Table > Distribute Rows Evenly or Distribute Columns Evenly.

[To the top](#)

Change the spacing before or after a table

1. Place the insertion point in the table and choose Table > Table Options > Table Setup.
2. Under Table Spacing, specify different values for Space Before and Space After, and then click OK.

Note that changing the spacing before the table does not affect the spacing of a table row that falls at the top of a frame.

[To the top](#)

Break tables across frames

Use Keep options to determine how many rows should remain together, or to specify where a row breaks, such as at the top of a column or frame.

When you create a table that is taller than the frame in which it resides, the frame is *overset*. If you thread the frame to another frame, the table continues in that frame. Rows move into threaded frames one at a time—you can't break a single row across multiple frames. Specify header or footer rows to repeat information in the new frame.

1. Position the insertion point in the appropriate row, or select a range of cells in the rows you want to keep together.
2. Choose Table > Cell Options > Rows And Columns.
3. To keep the selected rows together, select Keep With Next Row.
4. To cause the row to break in a specified location, select an option (such as In Next Frame) from the Start Row menu, and then click OK.

 If you create a single table that spans both pages of a spread, you may want to add a blank column in the middle of the table to create inset margins.

[To the top](#)

Add text before a table

A table is anchored to the paragraphs that immediately precede and follow it. If you insert a table at the beginning of the text frame, you can't click above the table to place an insertion point. Instead, use the arrow keys to move the insertion point before the table.

1. Place the insertion point at the beginning of the paragraph in the first cell, press the Left Arrow key, and begin typing.
2. Do one of the following:
 - Place the insertion point at the beginning of the paragraph in the first cell, press the left arrow key, and begin typing.

[To the top](#)

Format text within a table

In general, use the same methods to format text in a table that you would use to format text that's not in a table.

Insert tabs into a table cell

When the insertion point is in a table, pressing Tab moves the insertion point to the next cell. However, you can insert a tab within a table cell. Use the Tabs panel to define tab settings in the table. Tab settings affect the paragraph in which the insertion point is placed.

1. Using the Type tool , place the insertion point where you want to insert a tab.
2. Choose Type > Insert Special Character > Other > Tab.

To change tab settings, select the columns or cells you want to affect, choose Type > Tabs to display the Tabs panel, and then adjust tab settings.

Note: When you use the Tabs ruler to apply a decimal tab to a cell or group of cells, you usually don't need to press Tab at the beginning of each paragraph to decimal-align the text in the cells. Paragraphs are automatically aligned on the decimal character, unless the paragraph contains additional formatting, such as center alignment, that overrides the decimal tab.

Change the alignment of text within a table cell

1. Using the Type tool **T**, select the cell or cells you want to affect.
2. Choose Table > Cell Options > Text.
3. Under Vertical Justification, select an Align setting: Align Top, Align Center, Align Bottom, or Justify Vertically.

If you select Justify, specify the Paragraph Spacing Limit; this will set a maximum amount of space to be added between paragraphs. (See Align or justify text vertically within a text frame.)

4. For First Baseline, select an option to determine how text is to be offset from the top of the cell.

The settings are the same as the corresponding settings in the Text Frame Options dialog box. (See Change text frame properties.)

5. Click OK.

Note: To change the horizontal alignment of text within a cell, use the alignment option in the Paragraph panel. To align text in a cell to a decimal tab, use the Tabs panel to add a decimal tab setting.

Rotate text in a cell

1. Position the insertion point in the cell you want to rotate, or select the cells you want to affect.
2. Choose Table > Cell Options > Text, or display the Table panel.
3. Select a value for Rotation, and click OK.

Change cell inset spacing

1. Using the Type tool **T**, place the insertion point in or select the cell or cells you want to affect.
2. Choose Table > Cell Options > Text, or display the Table panel.
3. Under Cell Insets, specify values for Top, Bottom, Left, and Right, and then click OK.

In many cases, increasing the cell inset spacing will increase the row height. If the row height is set at a fixed value, make sure that you leave enough room for the inset values, to avoid causing overset text.

[To the top](#)

Merge and split cells

You can merge (combine) or split (divide) cells in a table.

Merge cells

You can combine two or more cells in the same row or column into a single cell. For example, you can merge the cells in the top row of the table to create a single cell to be used for the table title.

1. Using the Type tool **T**, select the cells you want to merge.

2. Choose Table > Merge Cells.

Unmerge cells

- Place the insertion point in the merged cell and choose Table > Unmerge Cells.

Split cells

You can split cells horizontally or vertically, which is especially useful when creating form tables. You can select multiple cells and split them vertically or horizontally.

1. Place the insertion point in the cell you want to split, or select a row, column, or block of cells.

2. Choose Table > Split Cell Vertically or Split Cell Horizontally.

[To the top](#)

Work with overset cells

In most cases, a table cell will expand vertically to accommodate new text and graphics being added. However, if you set a fixed row height and add text or graphics that are too large for the cell, a small red dot appears in the lower-right corner of the cell, indicating that the cell is overset.

You cannot flow overset text into another cell. Instead, edit or resize the contents, or expand the cell or the text frame in which the table appears.

In the case of inline graphics or text with fixed leading, it is possible for the cell contents to extend beyond cell edges. You can select the Clip Contents To Cell option, so that any text or inline graphics that otherwise extend beyond any cell edge are clipped to the cell boundary. However, when inline graphics are overset to extend beyond cell bottom edges (Horizontal), this does not apply.

Display the contents of an overset cell

- Do one of the following:
 - Increase the size of the cell.
 - Change the text formatting. To select the cell's contents, click in the overset cell, press Esc, and then use the Control panel to format the text.

Clip an image in a cell

If an image is too large for a cell, it extends beyond the cell borders. You can clip the parts of the image that extend beyond the cell borders.

1. Place the insertion point in the cell you want to clip, or select the cell or cells you want to affect.

2. Choose Table > Cell Options > Text.

3. Select Clip Contents To Cell, and then click OK.

Adobe also recommends



Twitter™ and Facebook posts are not covered under the terms of Creative Commons.

[Legal Notices](#) | [Online Privacy Policy](#)

Creating tables

Create tables

Add text to a table

Add graphics to a table

Add table headers and footers

A table consists of rows and columns of cells. A cell is like a text frame in which you can add text, anchored frames, or other tables. Create tables in Adobe InDesign CS5 or export them from other applications.

Note: To create, edit, and format tables in Adobe InCopy, make sure you are in Layout view.

[To the top](#)

Create tables

A table consists of rows and columns of cells. A cell is like a text frame in which you can add text, inline graphics, or other tables. You can create tables from scratch or by converting them from existing text. You can also embed a table within a table.

When you create a table, the new table fills the width of the container text frame. A table is inserted on the same line when the insertion point is at the beginning of the line, or on the next line, when the insertion point is in the middle of a line.

Tables flow with surrounding text just as inline graphics do. For example, a table moves through threaded frames when the text above it changes in point size or when text is added or deleted. However, a table cannot appear on a text-on-path frame.

Michael Murphy provides an article on creating and formatting tables at [Mind Your Table Manners](#).

Jeff Witchell from InfiniteSkills.com provides a video demonstration on [The basics of setting up tables](#).

Create a table from scratch

The table you create fills the width of the text frame.

1. Using the Type tool , place the insertion point where you want the table to appear.
2. Choose Table > Insert Table.
3. Specify the numbers of rows and columns.
4. If your table contents will continue on more than one column or frame, specify the number of header or footer rows in which you want the information to be repeated.
5. (Optional) Specify a table style.
6. Click OK.

The row height of a table is determined by the specified table style. For example, a table style may use cell styles to format different parts of the table. If any of these cell styles include paragraph styles, the leading value of the paragraph styles determines the row height of that area. If no paragraph style is used, the document's default slug determines the row height. (The slug is based on the leading value. In this context, a *slug* is the approximate height of the highlighting in selected text.)

Create a table from existing text

Before you convert text to a table, make sure that you set up the text properly.

1. To prepare the text for conversion, insert tabs, commas, paragraph returns, or another character to separate columns. Insert tabs, commas, paragraph returns, or another character to separate rows. (In many instances, text can be converted to a table without having to be edited.)
2. Using the Type tool **T**, select the text you want to convert to a table.
3. Choose Table > Convert Text To Table.
4. For both Column Separator and Row Separator, indicate where new rows and columns should begin. Choose Tab, Comma, or Paragraph, or type the character, such as a semicolon (;), in the Column Separator and Row Separator field. (Any character you type appears in the menu the next time you create a table from text.)
5. If you specify the same separator for columns and rows, indicate the number of columns you want the table to include.
6. (Optional) Specify a table style to format the table.
7. Click OK.

If any row has fewer items than the number of columns in a table, empty cells fill out the row.

Embed a table within a table

1. Do one of the following:
 - Select the cells or table you want to embed, and then choose Edit > Cut or Copy. Place the insertion point in the cell where you want the table to appear, and then choose Edit > Paste.
 - Click inside a cell, choose Table > Insert Table, specify the number of rows and columns, and then click OK.
2. Adjust the cell inset as necessary. (See Format text within a table.)

If you create a table within a cell, you cannot use the mouse to select any part of the table that oversets the cell boundary. Instead, expand the row or column; or place the insertion point in the first part of the table, and use keyboard shortcuts to move the insertion point and select text.

Importing tables from other applications

When you use the Place command to import a Microsoft Word document that includes tables, or a Microsoft Excel spreadsheet, imported data is an editable table. You can use the Import Options dialog box to control the formatting.

You can also paste data from an Excel spreadsheet or a Word table into an InDesign or InCopy document. The Clipboard Handling preference settings determine how text pasted from another application is formatted. If Text Only is selected, the information appears as unformatted tabbed text, which you can then convert to a table. If All Information is selected, the pasted text appears in a formatted table.

If you're pasting text from another application into an existing table, insert enough rows and columns to accommodate the pasted text, select the Text Only option in Clipboard Handling preferences, and make sure that at least one cell is selected (unless you want to embed the pasted table into a cell).

If you want more control over formatting the imported table, or if you want to maintain spreadsheet formatting, use the Place command to import the table. If you want to maintain a link to the spreadsheet, select the Create Links When Placing Text And Spreadsheet Files option in File Handling preference settings.

 You can also copy and paste tabbed text across a selection of table cells. This technique is a great way to replace content while preserving formatting. For example, suppose you want to update the content of a formatting table in a monthly magazine. One possibility is to link to an Excel spreadsheet. However, if your content comes from a different source, you can copy the tabbed text containing the new content, select the range of cells in the formatted InDesign table, and paste.

[To the top](#)

Add text to a table

You can add text, anchored objects, XML tags, and other tables to table cells. The height of a table row expands to accommodate additional lines of text, unless you set a fixed row height. You cannot add footnotes to tables.

- Using the Type tool , do any of the following:
 - Position the insertion point in a cell, and type text. Press Enter or Return to create a new paragraph in the same cell. Press Tab to move forward through cells (pressing Tab in the last cell inserts a new row). Press Shift+Tab to move backwards through cells.
 - Copy text, position the insertion point in a cell, and then choose Edit > Paste.
 - Position the insertion point in a cell where you want to add text, choose File > Place, and then double-click a text file.

[To the top](#)

Add graphics to a table

- Do any of the following:
 - Position the insertion point where you want the graphic, choose File > Place, and then double-click the graphic's filename.
 - Position the insertion point where you want the graphic, choose Object > Anchored Object > Insert, and then specify settings. You can later add a graphic to the anchored object.
 - Copy a graphic or a frame, position the insertion point, and then choose Edit > Paste.

When you add a graphic that is larger than the cell, the cell height expands to accommodate the graphic, but the width of the cell doesn't change—the graphic may extend beyond the right side of the cell. If the row in which the graphic is placed is set to a fixed height, a graphic that is taller than the row height causes the cell to be *overset*.

 To avoid an overset cell, you may want to place the image outside the table, resize the image, and then paste it into the table cell.

[To the top](#)

Add table headers and footers

When you create a long table, the table may span more than one column, frame, or page. You can use headers or footers to repeat the information at the top or bottom of each divided portion of the table.

You can add header and footer rows when you create the table. You can also use the Table Options dialog box to add header and footer rows and change how they appear in the table. You can convert body rows to header or footer rows.



Address List	
Name	Region and City
East, Sydney	
South, Parramatta	
South, Sutherland	

Address List	
Name	Region and City
West, Tucson	
North, Sioux	
Central, Denver	
South, Milwaukee	

Header rows repeated once per frame

 To number tables sequentially, such as Table 1A, Table 1B, and so on, add a variable to the table header or footer. (See Create running captions for figures and tables.)

Convert existing rows to header or footer rows

1. Select the rows at the top of the table to create header rows, or at the bottom of the table to create footer rows.
2. Choose Table > Convert Rows > To Header or To Footer.

Change header or footer row options

1. Place the insertion point in the table, and then choose Table > Table Options > Headers And Footers.
2. Specify the number of header or footer rows. Blank rows may be added to the top or bottom of the table.
3. Specify whether the information in the header or footer appears in every text column (if text frames have more than one column), once per frame, or only once per page.
4. Select Skip First if you don't want the header information to appear in the first row of the table. Select Skip Last if you don't want the footer information to appear in the last row of the table.

The Skip First option is especially useful if you want to indicate that the header or footer is continued. For example, for a table that spans multiple pages, you may want the header text to be "Table 2 (Continued)." Since you don't want "(Continued)" to appear at the beginning of the table, select Skip First, and simply type **Table 2** in the first row of the table.

5. Click OK.

Remove header or footer rows

- Do any of the following:
 - Place the insertion point in the header or footer row, and then choose Table > Convert Rows > To Body.
 - Choose Table > Table Options > Headers And Footers, and then specify a different number of header rows or footer rows.

Adobe also recommends

 Twitter™ and Facebook posts are not covered under the terms of Creative Commons.

[Legal Notices](#) | [Online Privacy Policy](#)

Selecting and editing tables

Select table cells, rows, and columns

Insert rows and columns

Delete rows, columns, or tables

Change the alignment of a table within a frame

Navigate within a table

Cut, copy, and paste table contents

Move or copy a table

Convert tables to text

Combine tables

Working with tables in Story Editor

[To the top](#)

Select table cells, rows, and columns

When you select part or all of the text in a cell, that selection has the same appearance as would text selected outside a table. However, if the selection spans more than one cell, the cells and their contents are both selected.

If a table spans more than one frame, holding the mouse pointer over any header or footer row that is not the first header or footer row causes a lock icon to appear, indicating that you cannot select text or cells in that row. To select cells in a header or footer row, go to the beginning of the table.

Select cells

- Using the Type tool **T**, do any of the following:
 - To select a single cell, click inside a cell, or select text, and then choose Table > Select > Cell.
 - To select multiple cells, drag across a cell border. Be careful not to drag the column or row line so that you don't resize the table.

 To switch between selecting all of the text in a cell and selecting the cell, press **Esc**.

Select entire columns or rows

- Using the Type tool **T**, do any of the following:
 - Click inside a cell, or select text, and then choose Table > Select > Column or Row.
 - Move the pointer over the top edge of a column or the left edge of a row so that the pointer becomes an arrow shape (**↕** or **↔**), and then click to select the entire column or row.



Address List	
Lee	
Luebke	
Sanchez	
Stewart	
Rhoades	

Before and after selecting Row

Select all header, body, or footer rows

1. Click inside a table, or select text.
2. Choose Table > Select > Header Rows, Body Rows, or Footer Rows.

Select the entire table

- Using the Type tool **T**, do any of the following:
 - Click inside a table, or select text, and then choose Table > Select > Table.
 - Move the pointer over the upper left corner of the table so that the pointer becomes an arrow shape **↖**, and then click to select the entire table.

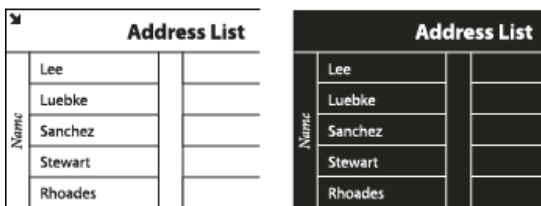

Address List	
Name	Lee
	Luebke
	Sanchez
	Stewart
	Rhoades

Before and after selecting table

- Drag the Type tool across the entire table.

 You can also select a table in the same way you select an anchored graphic—place the insertion point immediately before or after a table, and then hold down Shift while pressing the Right Arrow key or Left Arrow key, respectively, to select the table.

[To the top](#)

Insert rows and columns

You can insert rows and columns using a number of different methods.

Insert a row

1. Place the insertion point in a row below or above where you want the new row to appear.
2. Choose Table > Insert > Row.
3. Specify the number of rows you want.
4. Specify whether the new row or rows should appear before or after the current row, and then click OK.

The new cells have the same formatting as the text in the row in which the insertion point was placed.

 You can also create a new row by pressing Tab when the insertion point is in the last cell.

Insert a column

1. Place the insertion point in a column next to where you want the new column to appear.
2. Choose Table > Insert > Column.
3. Specify the number of columns you want.
4. Specify whether the new column or columns should appear before or after the current column, and then click OK.

The new cells have the same formatting as the text in the column in which the insertion point was placed.

Insert multiple rows and columns



1. With the insertion point in a cell, choose Table > Table Options > Table Setup.
2. Specify a different number of rows and columns, and then click OK.

New rows are added to the bottom of the table; new columns are added to the right side of the table.

 You can also change the number of rows and columns using the Table panel. To display the Table panel, choose Window > Type & Tables > Table.

Insert a row or column by dragging



When adding columns, if you drag more than one and one-half times the width of the column being dragged, new columns are added that have the same width as the original column. If you drag to insert only one column, that column can have a narrower or wider width than the column from where you dragged. The same behavior is true of rows, unless the Row Height for the row being dragged is set to At Least. In this case, if you drag to create only one row, InDesign will resize the new row, if necessary, so that it's tall enough to contain text.

1. Position the Type tool  over the border of a column or row so that a double-arrow icon ( or ) appears.
2. Hold down the mouse button, and then hold down Alt (Windows) or Option (Mac OS) while dragging down to create a new row, or to the right to create a new column. (If you press Alt or Option before holding down the mouse button, the Hand tool appears—so make sure you begin dragging before you press Alt or Option.)

Note: Dragging to insert rows or columns doesn't work at the top or left edges of a table. These fields are used to select rows or columns.

[To the top](#)

Delete rows, columns, or tables

- To delete a row, column, or table, place the insertion point inside the table, or select text in the table, and then choose Table > Delete > Row, Column, or Table.
- To delete rows and columns by using the Table Options dialog box, choose Table > Table Options > Table Setup. Specify a different number of rows and columns, and then click OK. Rows are deleted from the bottom of the table; columns are deleted from the right side of the table.
- To delete a row or column by using the mouse, position the pointer over the border of the bottom or right side of the table so that a double-arrow icon ( or ) appears; hold down the mouse button; and then hold down Alt (Windows) or Option (Mac OS) while dragging either up to delete rows, or to the left to delete columns.

Note: If you press Alt or Option before holding down the mouse button, the Hand tool will appear—so press Alt or Option after you begin dragging.

- To delete cell contents without deleting cells, select the cells containing the text you want to delete, or use the Type tool to select the text within the cells. Press Backspace or Delete, or choose Edit >Clear.

[To the top](#)

Change the alignment of a table within a frame

A table assumes the width of the paragraph or table cell in which it is created. However, you can change the size of the text frame or table so that the table is wider or narrower than the frame. In such a case, you can decide where you want the table to be aligned within the frame.

1. Place the insertion point to the right or left of the table. Make sure that the text insertion point is placed on the table paragraph and not inside the table. The insertion point becomes as tall as the table in the frame.
2. Click an alignment button (such as Align Center) in the Paragraph panel or Control panel.

[To the top](#)

Navigate within a table

Use the Tab or arrow keys to move within a table. You can also jump to a specific row, especially useful in long tables.

Move within a table using Tab

- Press Tab to move to the next cell. If you press Tab in the last table cell, a new row is created. For information on inserting tabs and indents in a table, see Format text within a table.
- Press Shift+Tab to move to the previous cell. If you press Shift+Tab in the first table cell, the insertion point moves to the last table cell.

Move within a table using arrow keys

Press the arrow keys to navigate within and between table cells. If you press the Right Arrow key when the insertion point is at the end of the last cell in a row, the insertion point moves to the beginning of the first cell in the same row. Similarly, if you press the Down Arrow key when the insertion point is at the end of the last cell in a column, the insertion point moves to the beginning of the first cell in the same column.

Jump to a specific row in a table

1. Choose Table > Go To Row.
2. Do any of the following:
 - Specify the row number you want to jump to, and then click OK.
 - If a header or footer row is defined in the current table, choose Header or Footer from the menu, and then click OK.

[To the top](#)

Cut, copy, and paste table contents

When text is selected within a cell, cutting, copying, and pasting actions are the same as for text selected outside a table. You can also cut, copy, and paste cells and their contents. If the insertion point is in a table when you paste, multiple pasted cells appear as a table within a table. You can also move or copy the entire table.

1. Select the cells you want to cut or copy, and then choose Edit > Cut or Copy.
2. Do any of the following:
 - To embed a table within a table, place the insertion point in the cell where you want the table to appear, and then choose Edit > Paste.
 - To replace existing cells, select one or more cells in the table—making sure that there are sufficient cells below and to the right of the selected cell—and then choose Edit > Paste.

[To the top](#)

Move or copy a table

1. To select the entire table, place the insertion point in the table and choose Table > Select > Table.
2. Choose Edit > Cut or Copy, move the insertion point where you want the table to appear, and then choose Edit > Paste.

[To the top](#)

Convert tables to text

1. Using the Type tool , place the insertion point inside the table, or select text in the table.
2. Choose Table > Convert Table To Text.
3. For both Column Separator and Row Separator, specify the separators you want to use.

For best results, use a different separator for columns and rows, such as tabs for columns and paragraphs for rows.

4. Click OK.

When you convert a table to text, the table lines are removed and the separator you specify is inserted at the end of each row and column.

[To the top](#)

Combine tables

Use the Paste command to merge two or more tables into a single table.

1. In the target table, insert at least as many blank rows as you'll be pasting from the other tables. (If you insert fewer rows than are copied, you cannot paste.)
2. In the source table, select the cells you want to copy. (If you copy more column cells than are available in the target table, you cannot paste.)
3. Select at least one cell where you want the incoming rows to be inserted, and then choose Edit > Paste.

 *If the pasted rows use different formatting than the rest of the table, define one or more cell styles, and then apply the cell styles to the pasted cells. Hold down Alt (Windows) or Option (Mac OS) while clicking the cell style to override existing formatting.*

Anne-Marie Concepcion provides an article about combining tables at [Joining Tables](#).

Working with tables in Story Editor

When you choose Edit > Edit In Story Editor, tables and their contents appear in Story Editor. You can edit tables in Story Editor.

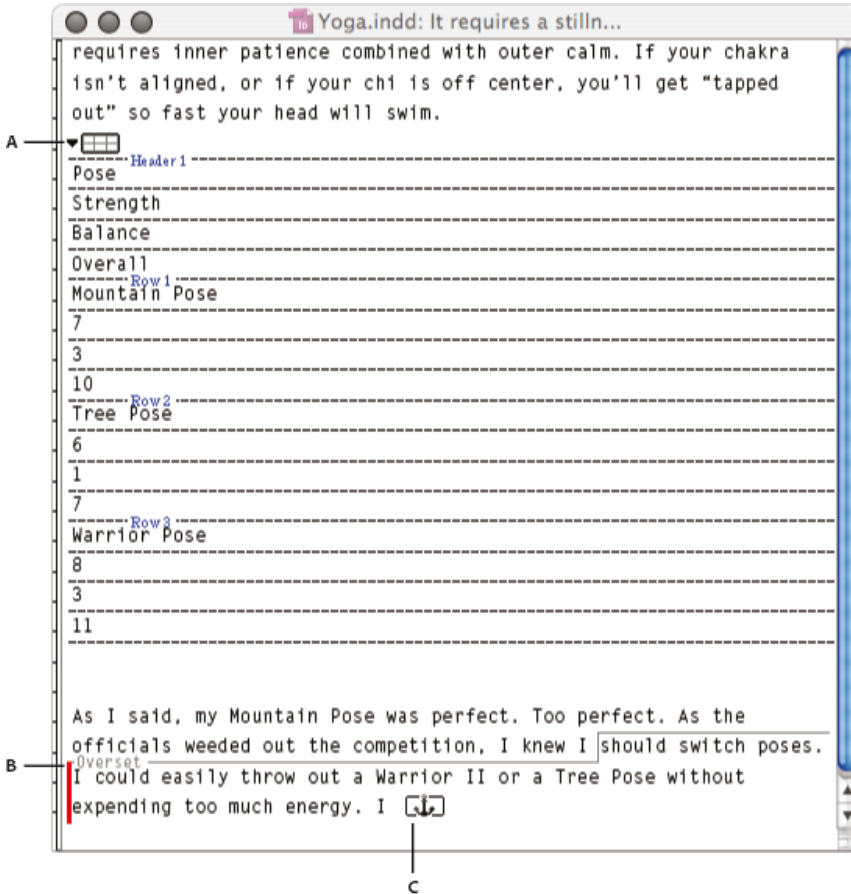

Editing tables in Story Editor
A. Table icon **B.** Overset graphic

- To expand or collapse the table in Story Editor, click the triangle to the left of the table icon at the top of the table.
- To determine whether the table is sorted by rows or columns, right-click (Windows) or Ctrl-click (Mac OS) the table icon and choose Arrange By Rows or Arrange By Columns.
- Use Layout view to modify and format the table. You cannot select columns or rows in Story Editor.

Adobe also recommends

Twitter™ and Facebook posts are not covered under the terms of Creative Commons.

[Legal Notices](#) | [Online Privacy Policy](#)

Table strokes and fills

[About table strokes and fills](#)

[Change the table border](#)

[Add stroke and fill to cells](#)

[Add diagonal lines to a cell](#)

[Table stroke and fill options](#)

[Alternate strokes and fills in a table](#)

[To the top](#)

About table strokes and fills

You can add strokes and fills to your tables in a number of ways. Use the Table Options dialog box to change the stroke of the table border, and to add alternating strokes and fills to columns and rows. To change the strokes and fills of individual cells or header/footer cells, use the Cell Options dialog box, or use the Swatches, Stroke, and Color panels.

By default, the formatting you select using the Table Options dialog box overrides any corresponding formatting previously applied to table cells. However, if you select the Preserve Local Formatting option in the Table Options dialog box, the strokes and fills applied to individual cells are not overridden.

If you use the same formatting repeatedly for tables or cells, create and apply table styles or cell styles.

[To the top](#)

Change the table border

You can change the table border by using either the Table Setup dialog box or the Stroke panel.

1. With the insertion point in a cell, choose **Table > Table Options > Table Setup**.
2. Under **Table Border**, specify the desired weight, type, color, tint, and gap settings. (See [Table stroke and fill options](#).)
3. Under **Stroke Drawing Order**, select the drawing order from the following options:

Best Joins If selected, row strokes will appear to the front at the points where strokes of different colors cross. In addition, when strokes such as double lines cross, the strokes are joined and the crossing points are connected.

Row Strokes In Front If selected, row strokes appear in front.

Column Strokes In Front If selected, column strokes appear in front.

InDesign 2.0 Compatibility If selected, row strokes appear in front. In addition, when strokes such as double lines cross, they are joined and the crossing points are connected only at points where strokes cross in a T-shape.

4. If you do not want stroke formatting of individual cells to be overridden, select **Preserve Local Formatting**.
5. Click **OK**.

 If you remove the stroke and fill from a table, choose **View > Extras > Show Frame Edges** to display the cell boundaries of a table.

Add stroke and fill to cells

You can add stroke and fill to cells using the Cell Options dialog box, Stroke panel, or Swatches panel.

Add stroke and fill using Cell Options

You can determine which cell lines are formatted with a stroke or fill by selecting or deselecting lines in the Preview proxy. If you want to change the appearance of all rows or columns in the table, use an alternating stroke or fill pattern in which the second pattern is set to 0.

1. Using the Type tool **T**, place the insertion point in or select the cell or cells in which you want to add a stroke or fill. To add a stroke or fill to header/footer rows, select the header/footer cells at the beginning of the table.
2. Choose Table > Cell Options > Strokes And Fills.
3. In the proxy preview area, specify which lines will be affected by stroke changes. For example, if you want to add a heavy stroke to the outside lines but not to the inside lines of the selected cells, click an inside line to deselect it. (Selected lines are blue; deselected lines are gray.)

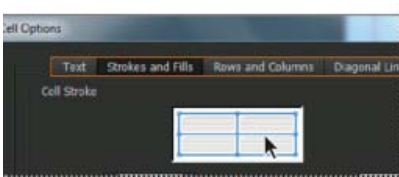

Select the lines you want to affect in proxy preview area.

💡 In the proxy preview area, double-click any outside line to select the entire outer selection rectangle. Double-click any inside line to select the inside lines. Triple-click anywhere in the proxy to select or deselect all lines.

4. For Cell Stroke, specify desired weight, type, color, tint, and gap settings. (See [Table stroke and fill options.](#))
5. For Cell Fill, specify desired color and tint settings.
6. Select Overprint Stroke and Overprint Fill if desired, and then click OK.



Add a stroke to cells using the Stroke panel

The Stroke panel is available in InDesign, not InCopy.

1. Select the cell or cells you want to affect. To apply a stroke to header or footer cells, select the header or footer row.
2. Choose Window > Stroke to display the Stroke panel.
3. In the proxy preview area, specify which lines will be affected by stroke changes.
4. In the Tools panel, make sure the Object button **□** is selected. (If the Text button **T** is selected, the stroke changes will affect the text, not the cells.)

5. Specify a weight value and stroke type.

Add a fill to cells using the Swatches panel

1. Select the cell or cells you want to affect. To apply a fill to header or footer cells, select the header or footer row.
2. Choose Window > Color > Swatches to display the Swatches panel.
3. Make sure the Object button  is selected. (If the Text button  is selected, the color changes will affect the text, not the cells.)
4. Select a swatch.

Add a gradient to cells using the Gradient panel

1. Select the cells you want to affect. To apply a gradient to header or footer cells, select the header or footer row.
2. Choose Window > Color > Gradient to display the Gradient panel.
3. Click in the Gradient Ramp to apply a gradient to the selected cells. Adjust the gradient settings as necessary.

[To the top](#)

Add diagonal lines to a cell

1. Using the Type tool , place the insertion point in or select the cell or cells in which you want to add diagonal lines.
2. Choose Table > Cell Options > Diagonal Lines.
3. Click the button for the type of diagonal line you want to add.
4. Under Line Stroke, specify desired weight, type, color, and gap settings; specify a Tint percentage and Overprint options.
5. From the Draw menu, choose Diagonal In Front to place the diagonal line in front of the cell contents; choose Content In Front to place the diagonal line behind the cell contents, and then click OK.

[To the top](#)

Table stroke and fill options

When selecting strokes and fills for the table or cells, use the following options:

Weight Specifies the line thickness for the table or cell border.

Type Specifies the line style, such as Thick - Thin.

Color Specifies the color of the table or cell border. The choices listed are those available in the Swatches panel.

Tint Specifies the percentage of ink of the specified color to be applied to the stroke or fill.

Gap Color Applies a color to the areas between the dashes, dots, or lines. This option is not available if Solid is selected for Type.

Gap Tint Applies tint to the areas between the dashes, dots, or lines. This option is not available if Solid is selected for Type.

Overprint When selected, causes the ink specified in the Color drop-down list to be applied over any underlying colors, rather than knocking out those inks.

[To the top](#)

Alternate strokes and fills in a table

You can alternate strokes and fills to enhance readability or improve the appearance of your table. Alternating strokes and fills in table rows does not affect header and footer rows. However, alternating strokes and fills in columns does affect header and footer rows.

Alternating stroke and fill settings override cell stroke formatting, unless you select the Preserve Local Formatting option in the Table Options dialog box.

 If you want to apply a fill or stroke to every body cell in the table, and not just alternating patterns, you can still use the alternating stroke and fill settings to create such non-alternating patterns. To create such an effect, specify 0 for Next in the second pattern.



Address List			
Lee	East, Tappan		
Laubke	East, Angel		
Sanchez	South, Fort		
Stewart	North, Stad		
Rhoades	West, Tappan		

Address List			
Lee	East, Tappan		
Laubke	East, Angel		
Sanchez	South, Fort		
Stewart	North, Stad		
Rhoades	West, Tappan		

Before (left) and after (right) alternating fills in a table

Add alternating strokes to a table

1. With the insertion point in a cell, choose Table > Table Options > Alternating Row Strokes or Alternating Column Strokes.
2. For Alternating Pattern, select the type of pattern you want to use. Select Custom if you want to specify a pattern; for example, one column with a thick black line followed by three columns with thin yellow lines.
3. Under Alternating, specify the fill options for both the first pattern and the next pattern. For example, you may want to add a solid stroke to the first column and a Thick - Thin line to the next column, so that they alternate. Specify 0 for Next if you want the strokes to affect every row or column.

Note: In tables that span multiple frames, alternating strokes and fills for rows do not restart at the beginning of additional frames in the story. (See Break tables across frames.)

4. Select Preserve Local Formatting if you want formatted strokes previously applied to the table to remain in effect.
5. For Skip First and Skip Last, specify the number of rows or columns at the beginning and end of the table in which you do not want stroke attributes to appear, and then click OK.

Add alternating fills to a table

1. With the insertion point in a cell, choose Table > Table Options > Alternating Fills.
2. For Alternating Pattern, select the type of pattern you want to use. Select Custom if you want to specify a pattern, such as one row shaded in gray followed by three rows shaded in yellow.
3. Under Alternating, specify the fill options for both the first pattern and the subsequent pattern. For example, if you selected Every Second

Column for Alternating Pattern, you may want to shade the first two columns in a gray tint and leave the next two columns blank. Specify 0 for Next if you want the fill to apply to every row.

4. Select Preserve Local Formatting if you want previously formatted fills applied to the table to remain in effect.
5. For Skip First and Skip Last, specify the number of rows or columns at the beginning and end of the table in which you do not want fill attributes to appear, and then click OK.

Turn off alternating strokes and fills in a table

1. Place the insertion point in the table.
2. Choose Table > Table Options > Alternating Row Strokes, Alternating Column Strokes, or Alternating Fills.
3. For Alternating Pattern, choose None, and then click OK.

Adobe also recommends

 Twitter™ and Facebook posts are not covered under the terms of Creative Commons.

[Legal Notices](#) | [Online Privacy Policy](#)

Interactivity

[Creating and editing motion presets \(video 5:23\)](#)

Anne-Marie Concepcion (Jan. 1, 2011)

video-tutorial

See how to edit and customize motion path presets, which allow you to animate images or text in InDesign.

[Creating cross-references \(video 5:45\), CS4-CS6](#)

David Blatner (Jan. 1, 2011)

video-tutorial

Walk through the procedure of adding cross-references. Create cross-references that can be updated quickly when the target text or pagination changes. Create a custom cross-reference format.

[Creating documents with Interactive features \(video 8:06\)](#)

Anne-Marie Concepcion (Jan. 1, 2011)

video-tutorial

Learn how to use the Media panel, the Preview panel, and the Timing panel to determine what happens when.

[Creating interactive documents in a snap \(PDF, 201 KB\)](#)

article (Jan. 1, 2011)

A handy tutorial on how to add interactivity to your documents.

[Creating multistate objects \(PDF, 203 KB\)](#)

article (Jan. 1, 2011)

This short tutorial shows you how to create multi-state objects to add interactivity.

[Creating rich interactive documents \(PDF, 6.7 MB\)](#)

article (Jan. 1, 2011)

Learn how to create rich interactive documents using InDesign.

[Exploring new FLA export options \(video 6:26\)](#)

Anne-Marie Concepcion (Jan. 1, 2011)

video-tutorial

See how to publish your InDesign project in a variety of Flash formats by using the enhanced Export dialog box in InDesign CS5 and later.

Hyperlinks

Hyperlinks panel overview

Create hyperlinks

Manage hyperlinks

Editing hyperlinks imported from Word

[To the top](#)

Hyperlinks panel overview

You can create hyperlinks so that when you export to Adobe PDF or SWF in InDesign, a viewer can click a link to jump to other locations in the same document, to other documents, or to websites. Hyperlinks you export to PDF or SWF in InCopy are not active.

A *source* is hyperlinked text, a hyperlinked text frame, or a hyperlinked graphics frame. A *destination* is the URL, file, email address, page text anchor, or shared destination to which a hyperlink jumps. A source can jump to only one destination, but any number of sources can jump to the same destination.

A *source* is hyperlinked text or a hyperlinked graphic. A *destination* is the URL, file, email address, page, text anchor, or shared destination to which a hyperlink jumps. A source can jump to only one destination, but any number of sources can jump to the same destination.

Note: If you want the source text to be generated from the destination text, insert a cross-reference instead of adding a hyperlink. See *Cross-references*.

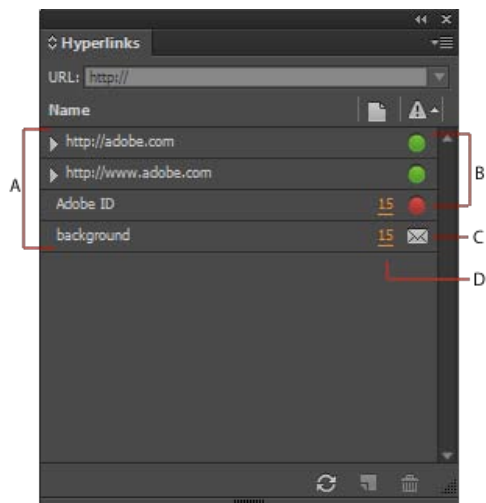

Hyperlinks panel

A. List of hyperlinks in the current document **B.** Traffic light indicators for instant feedback on URL availability **C.** Email link **D.** Clickable page number, takes you to the page where the link is and selects the link

Open the Hyperlinks panel

- Choose Window > Interactive > Hyperlinks.

Sort hyperlinks in the Hyperlinks panel

- Choose Sort from the Hyperlinks panel menu, and then choose any of the following:

Manually Displays the hyperlinks in the order in which they were added to the document.

By Name Displays the hyperlinks in alphabetical order.

By Type Displays the hyperlinks in groups of similar type.

Display hyperlinks in smaller rows

- Choose Small Panel Rows from the Hyperlinks panel menu.

[To the top](#)

Create hyperlinks

You can create hyperlinks to pages, URLs, text anchors, email addresses, and files. If you create a hyperlink to a page or text anchor in a different document, make sure that the exported files appear in the same folder.

 To show or hide hyperlinks, choose *View > Extras > Show Hyperlinks* or *Hide Hyperlinks*.

Note: Hyperlinks are included in exported Adobe PDF files if *Hyperlinks* is selected in the *Export Adobe PDF* dialog box in *InDesign*. Hyperlinks are included in the exported SWF file if *Include Hyperlinks* is selected in the *Export SWF* dialog box.

Create a hyperlink to a web page (URL)

You can use several different methods to create hyperlinks to URLs. When you specify a URL, you can use any valid Internet resource protocol: `http://`, `file://`, `ftp://`, or `mailto://`.

You can also use the Buttons feature to link to web pages. (See Buttons.)

Note: In *InDesign CC*, hyperlinks are automatically formatted with the *Hyperlink* style - underline blue text.

1. Right-click the selected text, frame, or graphic, and then choose *Hyperlinks > New Hyperlink*. The *New Hyperlink* dialog box is displayed.

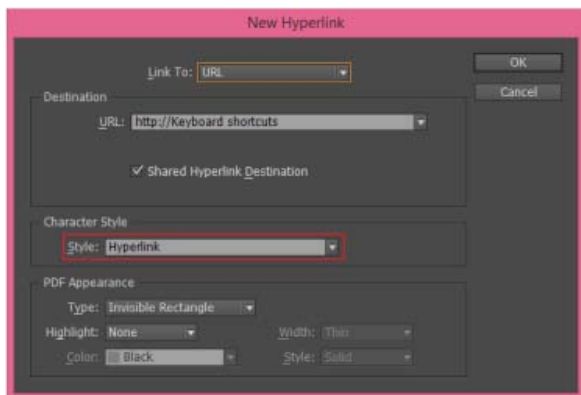

2. Specify an appropriate URL destination:

- In the URL text box, type or paste the URL name (such as <http://www.adobe.com>). Ensure that the URL option is selected in the Link To drop-down.

-OR-

- Select a previously added URL from the URL drop-down. The hyperlink appearance is the same as that used in the previous URL.

3. Click OK.

Note: *If a URL hyperlink isn't working in the exported PDF, there may be a problem with the hyperlink being a "Shared Destination". Deselect the Shared Hyperlink Destination checkbox, and then click OK.*

Create a hyperlink to a file

When you create a hyperlink to a file, clicking the hyperlink in the exported PDF or SWF file opens the file in its native application, such as Microsoft Word for .doc files.

Make sure the file you specify is available to anyone opening the PDF or SWF file you export. For example, if you're sending the exported PDF to a coworker, specify a file located on a shared server rather than your hard drive.

1. Select the text, frame, or graphic you want to be the source of the hyperlink.
2. Choose New Hyperlink in the Hyperlinks panel menu, or click the Create New Hyperlink button at the bottom of the Hyperlinks panel.
3. In the New Hyperlink dialog box, choose File from the Link To menu.
4. For Path, type the pathname or click the folder button to locate and double-click the filename.
5. Select Shared Hyperlink Destination if you want the file to be stored in the Hyperlinks panel for easy reuse.
6. Specify the appearance of the hyperlink source, and then click OK.

Create a hyperlink to an email message

1. Select the text, frame, or graphic you want to be the source of the hyperlink.
2. Choose New Hyperlink in the Hyperlinks panel menu, or click the Create New Hyperlink button at the bottom of the Hyperlinks panel.
3. In the New Hyperlink dialog box, choose Email from the Link To menu.
4. For Address, type the email address, such as `username@company.com`.
5. For Subject Line, type the text that appears in the subject line of the email message.
6. Select Shared Hyperlink Destination if you want the email message to be stored in the Hyperlinks panel for easy reuse.
7. Specify the appearance of the hyperlink source, and then click OK.

Create a hyperlink to a page

You can create a hyperlink to a page without first creating a destination. However, by creating a page destination, you can specify a page number and view setting.

1. Select the text, frame, or graphic you want to be the source of the hyperlink.
2. Choose New Hyperlink in the Hyperlinks panel menu, or click the Create New Hyperlink button at the bottom of the Hyperlinks panel.
3. In the New Hyperlink dialog box, choose Page from the Link To menu.
4. For Document, select the document containing the destination that you want to jump to. All open documents that have been saved are listed in the pop-up menu. If the document you're looking for isn't open, select Browse in the pop-up menu, locate the file, and then click Open.
5. For Page, specify the page number you want to jump to.
6. For Zoom Setting, do one of the following to select the view state of the page being jumped to:
 - Select Fixed to display the magnification level and page position that were in effect when you created the link.
 - Select Fit View to display the visible portion of the current page as the destination.
 - Select Fit In Window to display the current page in the destination window.
 - Select Fit Width or Fit Height to display the width or height of the current page in the destination window.
 - Select Fit Visible to display the page so that its text and graphics fit the width of the window, which usually means that the margins are not displayed.
 - Select Inherit Zoom to display the destination window at the magnification level the reader uses when the hyperlink is clicked.
7. Specify appearance options, and then click OK.

Create a hyperlink destination

Creating a hyperlink destination is necessary only if you're creating a hyperlink or cross-reference to a *text anchor*. A text anchor can point to a selection of text or to the insertion point location. Then you create the hyperlink or cross-reference that points to the hyperlink destination. You can also create hyperlink destinations for pages and URLs, but a destination isn't necessary for those links.

Hyperlink destinations you create do not appear in the Hyperlinks panel; they appear in the dialog box that appears when you're creating or editing hyperlinks.

1. If you're creating a text anchor, use the Type tool to place the insertion point, or select the range of text that you want to be the anchor.

You cannot set up an anchor destination for text on a master page.

2. Choose New Hyperlink Destination in the Hyperlinks panel menu.
3. Choose Text Anchor in the Type menu. Specify a name for the text anchor, and then click OK.
4. Do any of the following, and then click OK:
 - Choose Text Anchor in the Type menu. Specify a name for the text anchor.
 - Choose Page in the Type menu. Specify the page number you want to jump to and the Zoom Setting. Type a name for the page, or select Name With Page Number to name the destination automatically based on the page number and zoom setting you specify.
 - Choose URL in the Type menu. Type or paste a URL, such as *http://www.adobe.com*. You can use any valid Internet resource protocol:

http://, file://, ftp://, or mailto://.

Create a hyperlink to a text anchor

1. Select the text, frame, or graphic you want to be the source of the hyperlink.
2. Choose New Hyperlink in the Hyperlinks panel menu, or click the Create New Hyperlink button at the bottom of the Hyperlinks panel.
3. Choose Text Anchor from the Link To menu.
4. For Document, select the document containing the destination that you want to jump to. All open documents that have been saved are listed in the pop-up menu. If the document you're looking for isn't open, select Browse in the pop-up menu, locate the file, and then click Open.
5. From the Text Anchor menu, choose the text anchor destination you created.
6. Specify hyperlink appearance options, and then click OK.

Create a hyperlink to any shared destination

While creating a hyperlink, if you choose Shared Destination from the Link To menu, you can specify any named destination. A destination is named when you add a URL using the URL text box or when you select Shared Hyperlink Destination while creating a hyperlink to a URL, file, or email address.

1. Select the text, frame, or graphic you want to be the source of the hyperlink.
2. Choose New Hyperlink in the Hyperlinks panel menu, or click the Create New Hyperlink button at the bottom of the Hyperlinks panel.
3. In the New Hyperlink dialog box, choose Shared Destination from the Link To menu.
4. For Document, select the document containing the destination that you want to jump to. All open documents that have been saved are listed in the pop-up menu. If the document you're looking for isn't open, select Browse in the pop-up menu, locate the file, and then click Open.
5. Choose a destination from the Name menu.
6. Specify hyperlink appearance options, and then click OK.

Hyperlink appearance options

The options determine the appearance of the hyperlink or cross-reference source in the exported PDF or SWF file. These appearance options are also displayed in the InDesign document if you choose View > Extras > Show Hyperlinks.

Character Style Choose a character style to apply to the hyperlink source. By default, InDesign applies the *Hyperlink* style to the selected text or object. For text, you can easily select a different style from the Style drop-down in the New Hyperlink dialog box. For a non-text object, InDesign applies a design time visual identifier to the links – dotted line around the object with the color inherited from layer color.

Character style applied to text links



The character style is added to the document character style list. The style is printed and exported.

Visual identifier applied to object links



A dotted outline is applied to the linked objects. It's a visual identifier only and is not printed or exported.

Type Select Visible Rectangle or Invisible Rectangle.

Highlight Select Invert, Outline, Inset, or None. These options determine the appearance of the hyperlink when it's being clicked in the PDF or SWF file.

Color Select a color for the visible hyperlink rectangle.

Width Select Thin, Medium, or Thick to determine the thickness of the hyperlink rectangle.

Style Select Solid or Dashed to determine the appearance of the hyperlink rectangle.

Convert URLs to hyperlinks

You can find and convert URLs (such as “www.adobe.com”) in your document and convert them to hyperlinks.

1. Choose Convert URLs To Hyperlinks from the Hyperlinks panel menu.
2. For Scope, indicate whether you want to convert URLs in the entire document, the current story, or the current selection.
3. To apply a character style to the hyperlink, select a character style from the Character Style menu.
4. Do any of the following, and then click Done.
 - Click Find to locate the next URL.
 - Click Convert to convert the current URL to a hyperlink.
 - Click Convert All to convert all URLs to hyperlinks.

Manage hyperlinks

Use the Hyperlinks panel to edit, delete, reset, or locate hyperlinks. In InCopy, you can manage hyperlinks only if the story is checked out for editing.

Edit hyperlinks

1. Right-click the hyperlinked text or object, and then choose Hyperlinks > Edit Hyperlink.

-OR-

In the Hyperlinks panel, double-click the item you want to edit.

2. In the Edit Hyperlinks dialog box, make changes to the hyperlink as necessary, and then click OK.

Note: To edit a hyperlink to a URL, select the hyperlink, edit the URL in the URL text box, and then press Tab or Enter.

Delete hyperlinks

When you remove a hyperlink, the source text or graphic remains.

- Select the item or items you want to remove in the Hyperlinks panel, and then click the Delete button at the bottom of the panel.

Rename a hyperlink source

Renaming the hyperlink source changes the way it appears in the Hyperlinks panel.

1. In the Hyperlinks panel, select the hyperlink.
2. Choose Rename Hyperlink from the Hyperlinks panel menu, and specify a new name.

Edit or delete hyperlink destinations

1. Open the document in which the destination appears.
2. Choose Hyperlink Destination Options in the Hyperlinks panel menu.
3. For Destination, select the name of the destination you want to edit.
4. Do one of the following:
 - Click Edit, and then make changes to the destination as necessary.
 - Click Delete to remove the destination.
5. When you have finished editing or deleting destinations, click OK.

Reset or update hyperlinks

1. Select the range of text, the text frame, or the graphic frame that will act as the new hyperlink source. For example, you may want to select additional text to include in the source.
2. Select the hyperlink in the Hyperlinks panel.
3. Do either of the following:
 - Choose Reset Hyperlink in the Hyperlinks panel menu.
 - To update hyperlinks to external documents, choose Update Hyperlink in the Hyperlinks panel menu.

Go to a hyperlink source or anchor

- To locate the source of a hyperlink or cross-reference, select the item you want to locate in the Hyperlinks panel. Choose Go To Source in the Hyperlinks panel menu. The text or frame will be selected.
- To locate the destination of a hyperlink or cross-reference, select the item you want to locate in the Hyperlinks panel. Choose Go To Destination in the Hyperlinks panel menu.

If the item is a URL destination, InDesign starts or switches to your web browser to display the destination. If the item is a text anchor or page destination, InDesign jumps to that location.

[To the top](#)

Editing hyperlinks imported from Word

When a Microsoft Word document with hyperlinks is imported into an InDesign document, you may notice a box or border around the hyperlink URLs (such as www.adobe.com). The InDesign document inherits a blue swatch called Word_R0_G0_B255. The document also inherits a character style called "Hyperlink" that underlines the text and applies the blue color.

To remove the box, in the Hyperlinks panel, double-click the hyperlink. Under Appearance, choose Invisible Rectangle from the Type menu, and click OK.

You may also want to delete the imported swatch. While doing so, you can replace it with a different swatch. See Delete individual swatches.

 *Before you place the Word document in InDesign, you may want to remove the hyperlinks from the URLs in the Word document to avoid inheriting this formatting. See your Word documentation. Another option is to create a character style named "Hyperlink" in the InDesign document before you import. When you import the Word document, the InDesign style that has the same name is used by default.*

Adobe also recommends

- Export to PDF for printing

 Twitter™ and Facebook posts are not covered under the terms of Creative Commons.

[Legal Notices](#) | [Online Privacy Policy](#)

Cross-references

- [Insert cross-references](#)
- [Using cross-reference formats](#)
- [Manage cross-references](#)

If you're writing a manual or reference document, you may want to include a cross-reference to refer the reader from one part of your document to another. Example: **For more information, see "Field mice" on page 249.** You can specify whether a cross-reference derives from a paragraph style, such as a heading style, or from a text anchor you've created. You can also determine the cross-reference format, such as Page Number Only or Full Paragraph & Page Number.

[To the top](#)

Insert cross-references

Use the Hyperlinks panel to insert cross-references into your document. The text being referred to is the *destination text*. The text that is generated from the destination text is the *source cross-reference*.

When you insert a cross-reference in your document, you can choose from several predesigned formats, or you can create your own custom format. You can apply a character style to the entire cross-reference source, or to text within the cross-reference. Cross-reference formats can be synchronized across a book.

Cross-reference source text is editable and can break across lines.

Note: Cross-references are included in exported Adobe PDF files if *Hyperlinks* is selected in the *Export Adobe PDF* dialog box in *InDesign*. Cross-references are included in the exported SWF file if *Include Hyperlinks* is selected in the *Export SWF* dialog box.

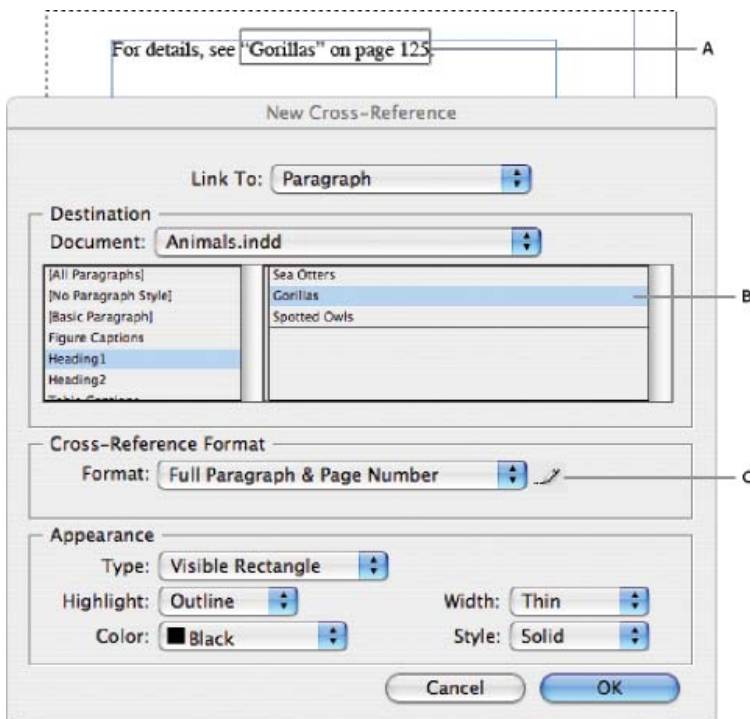

Inserting cross-references

A. Cross-reference source in document **B.** Selected destination paragraph **C.** Click here to create or edit cross-reference format.

1. Place the insertion point where you want the cross-reference to be inserted.

2. Do any of the following:

- Choose Type > Hyperlinks & Cross-References > Insert Cross-Reference.
- Choose Window > Type & Tables > Cross-References, and then choose Insert Cross-Reference from the panel menu.
- Click the Create New Cross-Reference button in the panel.

3. In the New Cross-Reference dialog box, choose Paragraph or Text Anchor from the Link To menu.

If you choose Paragraph, you can create a cross-reference to any paragraph in the document you specify.

If you choose Text Anchor, you can create a cross-reference to any text in which you have created a hyperlink destination. (See Create a hyperlink destination.) Creating a text anchor is especially useful if you want to use different text than the actual destination paragraph.

4. For Document, select the document containing the destination that you want to refer to. All open documents that have been saved are listed in the pop-up menu. If the document you're looking for isn't open, choose Browse, locate the file, and then click Open.

5. Click a paragraph style (such as Head1) in the left box to narrow down the choices, and then select the paragraph you want to refer to. (Or, if Text Anchor is selected, choose the text anchor.)

6. Choose the cross-reference format you want to use from the Format menu.

You can edit these cross-reference formats or create your own. See [Using cross-reference formats](#).

7. Specify the appearance of the source hyperlink. See Hyperlink appearance options.

8. Click OK.

When you insert a cross-reference, a text anchor marker ¶ appears at the beginning of the destination paragraph. You can view this marker when you choose Type > Show Hidden Characters. If this marker is moved or deleted, the cross-reference becomes unresolved.

[To the top](#)

Using cross-reference formats

Several cross-reference formats appear in the New Cross-Reference dialog box by default. You can edit these formats, delete them, or create your own.

Note: *If you've deleted or edited cross-reference formats in your document and want to return them to the default formats, you can choose Load Cross-Reference Formats from the panel menu and choose a document with unedited formats. You can also synchronize cross-reference formats in a book.*

Create or edit cross-reference formats

Unlike other presets, cross-reference formats can be edited or deleted. When you edit a cross-reference format, any source cross-reference that uses that format is automatically updated.



1. Do any of the following:

- Choose Define Cross-Reference Formats from the Cross-References panel menu.
- While creating or editing a cross-reference, click the Create Or Edit Cross-Reference Formats button .

2. In the Cross-Reference Formats dialog box, do one of the following:

- To edit a format, select the format on the left.
- To create a format, select a format to base the new format on, and then click the Create Format button . This creates a duplicate of the selected format.

3. For Name, specify the name of the format.

4. In the Definition text box, add or remove any text as needed. Click the Building Block icon  to insert building blocks from a menu. Click the Special Characters icon  to select dashes, spaces, quotation marks, and other special characters.

5. To apply a character style to the entire cross-reference, select Character Style For Cross-Reference, and then choose or create the character style from the menu.

You can also use the Character Style building block to apply a character style to text within the cross-reference.

6. Click Save to save the changes. Click OK when finished.

Cross-reference building blocks

Building block	What it does	Example
Page Number	Inserts the page number.	on page <pageNum/> on page 23
Paragraph Number	Inserts the paragraph number in a cross-reference to a numbered list.	See <paraNum/> See 1 In this example, only “1” is used from the paragraph, “1. Animals.”
Paragraph Text	Inserts the paragraph text without the paragraph number in a cross-reference to a numbered list.	See “<paraText/>” See “Animals” In this example, only “Animals” is used from the paragraph, “1. Animals.”
Full Paragraph	Inserts the entire paragraph, including paragraph number and paragraph text.	See “<fullPara/>” See “1. Animals”
Partial Paragraph	Lets you create a cross-reference to the first part of a paragraph, up to the specified delimiter, such as a colon or em dash.	See <fullPara delim=“:” includeDelim=“false”/> See Chapter 7 In this example, only “Chapter 7” is used from the title “Chapter 7: Dogs and Cats.” Specify the delimiter (such as : in this example), and indicate whether the delimiter is excluded (“false” or “0”) or included (“true” or “1”) in the source cross-reference.

		See Creating cross-references to partial paragraphs .
Text Anchor Name	Inserts the text anchor name. You can create text anchors by choosing New Hyperlink Destination from the Hyperlinks panel menu.	See <txtAnchrName/> See Figure 1
Chapter Number	Inserts the chapter number.	in chapter <chapNum/> in chapter 3
File Name	Inserts the filename of the destination document.	in <fileName/> in newsletter.indd
Character Style	Applies a character style to text within a cross-reference.	See <cs name="bold"><fullPara/></cs> on page <pageNum/> See Animals on page 23. Specify the character style name, and include the text you want to apply the character style to between the <cs name=""> and </cs> tags. See Apply character styles within a cross-reference .

Creating cross-references to partial paragraphs

You can design cross-reference formats to include only the first part of a paragraph. For example, if you have headings in your document that look like, “Chapter 7—Granada to Barcelona,” you can create a cross-reference that refers only to “Chapter 7.”

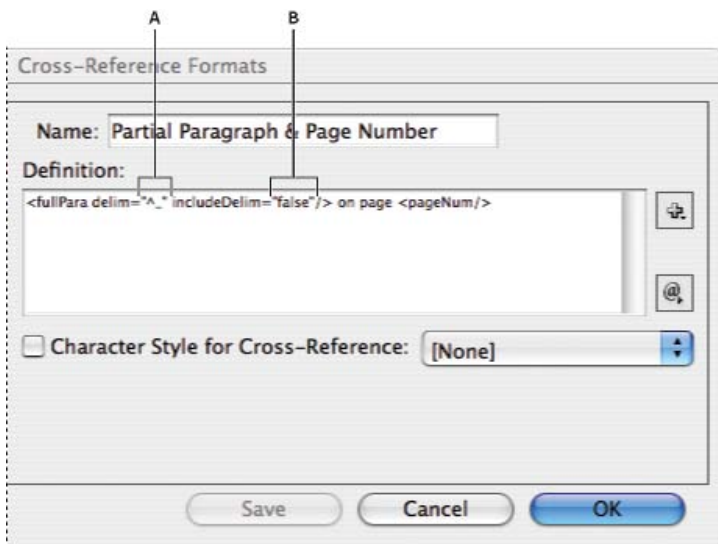

Cross-reference to partial paragraph

A. The cross-reference source ends at an em dash (^_) **B.** “false” excludes the em dash from the source

When you insert the Partial Paragraph building block, you must do two things. First, specify the delimiter between the quotation marks. The delimiter is the character that ends the paragraph. Common delimiters include colons (Chapter 7: Granada), periods (Chapter 7. Granada), and dashes (Chapter 7—Granada). To insert special characters such as em dashes (^_), em spaces (^m), and bullet characters (^8), choose an option from the menu that appears when you click the Special Characters icon.

Second, indicate whether the delimiter character is excluded (Chapter 7) or included (Chapter 7—). Use includeDelim="false" to exclude the delimiter and includeDelim="true" to include the delimiter. Instead of "false" or "true," you can use "0" or "1," respectively.

Apply character styles within a cross-reference

If you want to emphasize a section of text within a cross-reference, you can use the Character Style building block. This building block consists of two tags. The `<cs name="styleName">` tag indicates which style is applied, and the `</cs>` tag ends the character style. Any text or building blocks between these tags is formatted in the specified style.

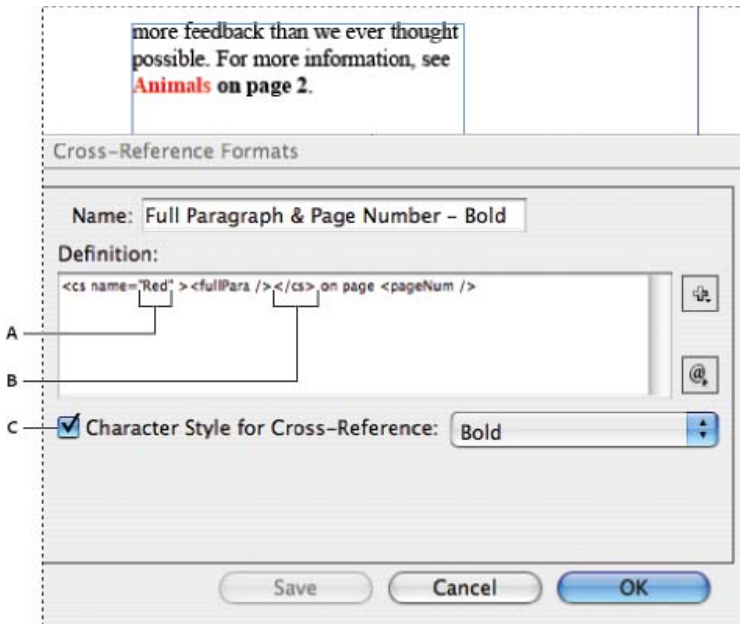

Applying a character style to a section of the cross-reference

A. This tag applies a character style named "Red." **B.** This tag ends the character style formatting. **C.** A character style named "Bold" is applied to the rest of the cross-reference source.

1. Create the character style you want to use.
2. In the Cross-Reference Formats dialog box, create or edit the format you want to apply.
3. Under Definition, select the text and building blocks to which you want to apply the character style.
4. Choose Character Style from the menu to the right of the definition list.
5. Type the name of the character style between the quotation marks exactly as it appears in the Character Styles panel.

Style names are case sensitive. If the character style is in a group, type the name of the group followed by a colon before the character style, such as `style Group 1: Red`.

6. Click Save to save the format, and then click OK.

Load (import) cross-reference formats

When you load cross-reference formats from another document, the incoming formats replace any existing formats that share the same name.

In InCopy, you can import cross-reference formats only in standalone documents. You cannot import formats from an InCopy document into an InDesign document. If the new or modified format in InCopy conflicts with a format in the InDesign document when the story is checked in, the InDesign format takes precedence.

1. Choose Load Cross-Reference Formats from the Cross-References panel menu.
2. Double-click the document containing the cross-reference formats you want to import.

You can also share cross-reference formats across documents by synchronizing a book.



Delete cross-reference formats

You cannot delete a cross-reference format that has been applied to cross-references in the document.

1. In the Cross-Reference Formats dialog box, select the format you want to delete.
2. Click the Delete Format button .

[To the top](#)

Manage cross-references

When you insert a cross-reference, the Hyperlinks panel indicates the status of the cross-reference. For example, icons indicate if the destination text appears on the pasteboard **PB**, a master page **MP**, a hidden layer **HL**, in overset text **OV**, or in hidden text **HT**. Cross-references that link to such destination areas are *unresolved*. The panel also lets you know if the destination paragraph has been edited  (also called *out-of-date*) or is missing . Destination text is *missing* if either the destination text or the file containing the destination text cannot be found. Hold the mouse pointer over any icon to view a tool tip description.

In InCopy, you can manage cross-references only if the story is checked out for editing.

Update cross-references

An update icon indicates that the cross-reference destination text has changed or that the cross-reference source text has been edited. You can easily update the cross-reference. If the destination moves to a different page, the cross-reference is updated automatically.

When you update a cross-reference, any formatting changes you've made to the source text are removed.

When printing or outputting, you are notified if cross-references are out of date or unresolved.

 *You can also use the Preflight panel to notify you when cross-references are out of date or unresolved. When defining a profile, select Cross-References in the Text section. See Define preflight profiles.*

1. Select one or more out-of-date cross-references. To update all cross-references, make sure that none are selected.
2. Do any of the following:
 - Click the Update Cross-References button  in the Cross-References panel.
 - Choose Update Cross-Reference from the Cross-References panel menu.
 - Choose Type > Hyperlinks & Cross-References > Update Cross-Reference.

To update all cross-references in a book, choose Update All Cross-References from the book panel menu. You are notified if any cross-references remain unresolved.

Relink cross-references

If the missing destination text has been moved to a different document, or if the document containing the destination text is renamed, you can relink the cross-reference. When you relink, any changes made to the source cross-reference are removed.

1. In the Cross-References panel, select the cross-reference you want to relink.
2. Choose Relink Cross-Reference from the panel menu.
3. Locate the document in which the destination text appears, and then click Open.

If any other destination text appears in that document, you can relink additional cross-references.

Edit cross-references

To change the appearance of the source cross-reference or specify a different format, you can edit the cross-reference. If you edit a cross-reference that links to a different document, the document is opened automatically.

1. Do any of the following:
 - Choose Type > Hyperlinks & Cross References > Cross-Reference Options.
 - In the Cross-References panel, double-click the cross-reference you want to edit.
 - Select the cross-reference, and choose Cross-Reference Options from the Cross-References panel menu.
2. Edit the cross-reference, and then click OK.

Delete cross-references

When you delete a cross-reference, the source cross-reference is converted to text.

1. In the Cross-References panel, select the cross-reference or cross-references you want to delete.
2. Click the Delete icon, or choose Delete Cross-Reference from the panel menu.
3. Click Yes to confirm.

To completely remove a cross-reference, you can also select the cross-reference source and delete it.

Editing cross-reference source text

You can edit cross-reference source text. The advantage of editing cross-reference text is that you can change tracking or word spacing as needed for copyfitting, or make other changes. The disadvantage is that if you update or relink the cross-reference, any local formatting changes are removed.



Twitter™ and Facebook posts are not covered under the terms of Creative Commons.

[Legal Notices](#) | [Online Privacy Policy](#)

Interactive web documents for Flash

[Create interactive SWF \(Flash\) files for the web](#)

[Create FLA files for the web](#)

[Flash export issues](#)

To create slideshow-type content that can be played in Flash Player, you can export to either SWF or FLA. The main difference is that SWF files are ready to be viewed and cannot be edited, whereas FLA files must be edited in Adobe Flash Professional to be viewed in Adobe Flash Player.

SWF An exported SWF file is ready for viewing in Adobe Flash Player and may include interactive elements such as page transitions, hyperlinks, movies, sound clips, animation, and navigation buttons.

FLA An exported FLA file includes only some interactive elements. The FLA file can be opened in Flash Pro, where you or a Flash developer can add advanced effects before exporting to SWF.

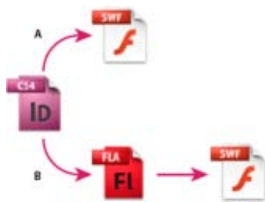

Export to Flash

A. Export directly to SWF **B.** Export to FLA for editing in Flash Professional

[To the top](#)

Create interactive SWF (Flash) files for the web

When you export to SWF, you create an interactive file that's ready for viewing in Adobe Flash Player or in a web browser. The SWF file can include buttons, page transitions, movies and audio files, animation, and hyperlinks added in InDesign. Exporting to SWF is a good way to create an interactive slideshow, or a flip book, based on an InDesign document.

If you want to edit the document in Flash Pro before creating the SWF file, export to FLA instead of SWF. See [Create FLA files for the web](#).



SWF export

A. Document in InDesign before SWF export **B.** Interactive SWF file in web browser

1. Create or edit the InDesign document to prepare it for Flash export. For more detailed information on setting up the document for export, see [Flash export issues](#).
 - Add navigation buttons that allow users to move from page to page in the exported SWF file. You can create a buttons by drawing an object and converting it to a button using the Buttons panel (choose Window > Interactive > Buttons). You can also use the Sample Buttons panel to drag predefined navigation buttons into your document. See [Create buttons](#).
 - Use the Page Transitions panel (choose Window > Interactive > Page Transitions) to add page transitions such as wipes or dissolves. When you export to SWF, you can also select the Include Interactive Page Curl option, which lets viewers drag a page corner to turn the page.
 - Use the Animation panel (choose Window > Interactive > Animation) to add motion presets. See [Animation](#).
2. To export the document to SWF format, choose File > Export. Choose Flash Player (SWF) from the Save As Type (Windows) or Format (Mac OS) menu, and click Save.
3. In the Export SWF dialog box, specify the options, and then click OK. See [SWF export options](#).

When you export a SWF file, separate HTML and SWF files are created. If the SWF file includes movies or sound clips, a Resources folder is also created. To hand off or upload the files to the web, make sure you send all the assets.

SWF export options

The following options appear on the General and Advanced tabs of the Export SWF dialog box.

Export Indicate whether the current selection, all pages in the document, or a page range is included. Choosing Selection is especially useful if you want to save the exported SWF file for use in an exported PDF file. If you select Range, specify a page range, such as 1–7, 9 to print pages 1 through 7 and 9. See Specifying pages to print.

Generate HTML File Select this option to generate an HTML page that plays back the SWF file. This option is especially useful for quickly previewing the SWF file in your web browser.

View SWF After Exporting Select this option to play back the SWF file in your default web browser. This option is available only if you generate an HTML file.

Size (pixels) Specify whether the SWF file is scaled by a percentage, fit to a monitor size you specify, or sized according to the width and height you specify.

Background Specify whether the background of your SWF is transparent or if it uses the current Paper color from the Swatches panel. Selecting Transparent disables the Page Transitions and Interactive Page Curl options.

Interactivity And Media Select Include All to allow movies, sounds, buttons, and animations to be interactive in the exported SWF file. Select Appearance Only to include the normal state of buttons and the video posters as static elements. If Appearance Only is selected, animations export as they appear in the layout at the time of export. Appearance Only is selected if you choose Flatten Transparency in the Advanced panel.

Page Transitions Specify one page transition to apply to all pages during export. If you use the Page Transitions panel to specify transitions, choose the From Document option to use those settings.

Include Interactive Page Curl If this option is selected, users playing the SWF file can drag a corner of the page to turn it, giving the appearance of turning the page in a real book.

Frame Rate Higher frame rates create smoother animations but may increase the file size. Changing the frame rate does not affect playback duration.

Text Specify how InDesign text is output. Choose Flash Classic Text to output searchable text that results in the smallest file size. Choose Convert To Outlines to output the text as a series of smooth straight lines, like converting text to outlines. Choose Convert To Pixels to output the text in a bitmap image. Text converted to pixels may appear jagged when zoomed in on.

Rasterize Pages This option converts all InDesign page items to bitmap. Selecting this option results in a larger SWF file, and page items may appear jagged when zoomed in on.

Flatten Transparency This option removes live transparency from the SWF and preserves the transparency appearance. However, all interactivity is removed from the exported SWF file if this option is selected.

Compression Choose Automatic to let InDesign determine the best quality for color and grayscale images. For most files, this option produces satisfactory results. Choosing JPEG (Lossy) is suitable for grayscale or color images. JPEG compression is lossy, which means that it removes image data and possibly reduces image quality. However, it attempts to reduce file size with a minimal loss of information. Because JPEG compression eliminates data, it can achieve much smaller file sizes. Choosing PNG (Lossless) exports the file without lossy compression.

 *If you notice a loss of image quality in transparent images when you export to SWF, choose PNG (Lossless) to improve the quality.*

JPEG Quality Specifies the amount of detail in the exported image. The higher the quality, the larger the file size. This option is dimmed if you choose PNG (Lossless) for Compression.

Resolution Specify the resolution of bitmap images in the exported SWF. Choosing a high resolution is especially important to allow viewers to zoom in on pixel-based content within your exported SWF. Choosing a high resolution can significantly increase the file size.

[To the top](#)

Create FLA files for the web

When you export your InDesign document to FLA file format, you can open the file in Adobe Flash® CS5 Professional to edit the contents. Exporting to FLA in InDesign CS5 format replaces XFL export in InDesign CS4. Use the Flash authoring environment to edit or add video, audio, animation, and complex interactivity.

If you want to export the InDesign document directly to a format that can be opened directly in a web browser, use the SWF format instead of FLA. See [Create interactive SWF \(Flash\) files for the web](#).



FLA export
A. Document in InDesign before FLA export **B.** FLA file opened in Flash Pro

1. Create or edit the InDesign document to prepare it for Flash export. For more detailed information on setting up the document for export, see [Flash export issues](#).
2. To export the document to FLA format, choose File > Export. Choose Flash CS5 Professional (FLA) from the Save As Type (Windows) or Format (Mac OS) menu, and click Save.
3. In the Export Flash CS5 Professional (FLA) dialog box, specify the options, and then click OK. For information on export options, see [FLA export options](#).
4. Open the exported FLA file in Flash Professional.

FLA export options

The following options appear in the Export Flash CS5 Professional (FLA) dialog box.

Export Indicate whether the current selection, all pages in the document, or a page range is included. If you select Range, specify a page range, such as 1–7, 9 to print pages 1 through 7 and 9. See [Specifying pages to print](#).

Rasterize Pages This option converts all InDesign page items to bitmap. Selecting this option results in a larger FLA file, and page items become jagged when zoomed in on.

Flatten Transparency Selecting this option flattens all objects with transparency. Flattened objects may be difficult to animate in Adobe Flash Pro.

Size (Pixels) Specify whether the FLA file is scaled by a percentage, fit to a monitor size you specify, or sized according to a width and height you specify.

Interactivity And Media Select Include All to allow movies, sounds, buttons, and animations to be included in the exported FLA file. If the document includes a multi-state object, it is converted into a movie clip symbol in which each state appears on its own frame in the timeline. Select Appearance Only to include the normal state of buttons and the video posters as static elements. If Appearance Only is selected, animations export as they appear in the layout at the time of export. Appearance Only is selected if you choose Flatten Transparency.

Text Specify how InDesign text is output. Choose Flash TLF Text to take advantage of the rich set of Text Layout Framework attributes in Flash Professional. If this option is selected, select Insert Dictionary Hyphenation Points to allow hyphenation. Choose Flash Classic Text to output searchable text that results in a small file size. Choose Convert To Outlines to output the text as a series of smooth straight lines, like converting text to outlines. Choose Convert To Pixels to output the text in a bitmap image. Text converted to pixels may appear jagged when zoomed in on.

Compression Choose Automatic to let InDesign determine the best quality for color and grayscale images. For most files, this option produces satisfactory results. Choosing JPEG (Lossy) is suitable for grayscale or color images. JPEG compression is lossy, which means that it removes image data and possibly reduces image quality. However, it attempts to reduce file size with a minimal loss of information. Because JPEG compression eliminates data, it can achieve much smaller files sizes. Choosing PNG (Lossless) exports the file without lossy compression.

JPEG Quality Specifies the amount of detail in the exported image. The higher the quality, the larger the file size. This option is dimmed if you choose PNG (Lossless) for Compression.

Resolution Specify the resolution of bitmap images in the exported FLA file. Choosing a high resolution is especially important to allow viewers to zoom in on pixel-based content. Choosing a high resolution can significantly increase the file size.

[To the top](#)

Flash export issues

Consider the following factors when designing your InDesign document for SWF or FLA output.

Document setup issues

How InDesign pages are converted When you export to SWF or FLA, InDesign spreads become separate clips in a timeline, like slides in a slideshow. Each spread is mapped to a new keyframe. In Flash Player, you advance through the spreads of the exported document by pressing arrow keys or clicking interactive buttons.

 *When creating a document intended for the web, choose Web from the Intent menu in the New Document dialog box.*

Page size When you create a document, you can choose a specific resolution, such as 800 x 600, from the Page Size menu in the New Document dialog box. During export, you can also adjust the scale or resolution of the exported SWF or FLA file.

Interactivity features

Buttons, page transitions, hyperlinks, animation, and media files can be included in exported SWF and FLA files.

Buttons For buttons in an exported SWF or FLA file, the Next Page and Previous Page actions are especially useful controls for playback in Flash Player. However, some actions that work in interactive PDF files have no effect in Flash Player. When you choose an action in the Buttons panel, do not select an option from the PDF Only section.



 You can add navigation buttons that are preformatted with *Go To Next Page* and *Go To Previous Page* actions. Choose *Sample Buttons* from the *Buttons* panel menu. See [Add a button from the Sample Buttons panel](#).

Page Transitions All page transitions work well in Flash Player. In addition to page transitions that appear when you turn the page, you can add include an interactive page curl during export that lets you drag corners of pages to turn them.

Hyperlinks Create links to websites or to other pages in the document. Hyperlinks are broken in FLA files.

Movies and sound clips Movies and sound clips are included in an exported SWF file if they're in a supported format, such as SWF, FLV, F4V, and MP4 for movies and MP3 for sound clips.

When you export to FLA, only the poster image is included in the FLA file. Supported media files appear in a resources folder saved in the same location as the exported FLA file.

Conversion issues

Color SWF and FLA files use RGB color. When a document is exported to SWF or FLA, InDesign converts all color spaces (such as CMYK and LAB) to sRGB. InDesign converts spot colors to equivalent RGB process colors.

To avoid unwanted color changes in artwork with text with transparency, choose *Edit > Transparency Blend Space > Document RGB*. To avoid unwanted color changes in images with transparency, avoid using a lossy compression during export.

Text When exporting to SWF or FLA, you can determine whether text is output as Flash text or converted to outlines or pixels. Text exported as Flash Classic Text remains fully editable when the FLA file is opened in Adobe Flash CS5 Professional and can be searched in web browsers when saved as SWF files.

Images When you export images to SWF or FLA, you can change image compression, JPEG quality, and resolution settings during export.

When you export images to FLA, an image placed multiple times in your InDesign document is saved as a single image asset with a shared location. Note that a large number of vector images in the InDesign document may cause performance problems in the exported file.

To reduce file size, place repeating images on master pages, and avoid copying and pasting images. If the same image is placed multiple times in the document and not transformed or cropped, only one copy of the file is exported in the FLA file. Images that are copied and pasted are treated as separate objects.

By default, a placed Illustrator file is treated as a single image in the FLA file, whereas an Illustrator file that's copied and pasted generates many individual objects. For best results, place the Illustrator image as a PDF file instead of copying and pasting from Illustrator. Copying and pasting results in multiple editable paths.

 You can change preference options to make sure that Illustrator objects are pasted as one object instead of a collection of small vectors. In *Illustrator File Handling & Clipboard* preferences, select *PDF* and *deselect AICB (No Transparency Support)*. In *InDesign Clipboard Handling* preferences, select both *Prefer PDF When Pasting* and *Copy PDF To Clipboard*.

Transparency Before exporting to SWF, make sure that transparent objects do not overlap any interactive element, such as a button or hyperlink. If an object with transparency overlaps an interactive element, the interactivity may be lost during export. You may want to flatten transparency before exporting to FLA.

In some instances, choosing a lossy compression reduces the quality of images with transparency. When exporting, choose PNG (Lossless) to improve the quality.

3D attributes 3D attributes are not supported in the exported SWF and FLA files.

 Twitter™ and Facebook posts are not covered under the terms of Creative Commons.

[Legal Notices](#) | [Online Privacy Policy](#)

Animation

Animate a document with motion presets

Manage motion presets

Edit a motion path

Use the Timing panel to change the animation order

Animation effects let you make objects move in your exported SWF files. For example, you can apply a motion preset to an image that makes it appear to fly in from the left side of the screen while shrinking and spinning. Use the following tools and panels to animate documents.



Click Play Button to view animation

Animation panel Apply a motion preset and edit settings such as duration and speed.

Direct Selection tool and Pen tool Edit the path on which the animated object travels.

Timing panel Determine the order in which objects on a page are animated.

Preview panel View the animation in an InDesign panel.

Note: A related type of animation you can add in InDesign is a button rollover effect. For more information, see [Create buttons](#).

Jeff Witchel from Infiniteskills.com provides a video overview on [Animating layouts](#).

[To the top](#)

Animate a document with motion presets

Motion presets are pre-made animations that you can apply to objects quickly. Use the Animation panel to apply motion presets and change animation settings such as duration and speed. The Animation panel also lets you specify when an animated object plays.

These motion presets are the same as those found in Adobe Flash CS5 Professional. You can import any custom motion preset created in Flash Professional. You can also save motion presets you create and use them in InDesign or Flash Professional.

 *Animation features are supported only when exporting to the Adobe Flash Player (.SWF). They are not supported when exporting to Interactive PDF. To add animation effects to a PDF file, export a selection as a SWF file from InDesign and place that SWF file in the InDesign document.*

1. Place the object you want to animate in your document.
2. In the Animation panel (Window > Interactive > Animation), choose a motion preset from the Preset menu.

3. Specify motion preset options.
4. To edit the motion path, use the Pen tool and Direct Selection tool.
5. Use the Timing panel to determine the order of the animation effects.
6. Use the Preview panel to preview the animation in InDesign.

To remove animation from an object, select the object and click the Delete icon in the Animation panel.

Note: When certain animation effects such as *Fade In* are combined with a page transition or page curl, the animation may not behave as expected in the Preview panel or in the exported SWF file. For example, objects that are set to "fade in" are visible while turning the page when they should start as invisible. To avoid this conflict, do not use page transitions on those pages with animation, and turn off the *Include Interactive Page Curl* option in the SWF Export dialog box. Motion presets that may not work as expected with page transitions and page curl include *Appear*, *Fade In*, the various *Fly-in* presets, *Zoom in 2D*, and *Swoosh*.

Convert selected objects to a motion path

You can create animation by selecting an object and a path and converting it to a motion path. If you selected two closed paths, such as two rectangles, the path on top becomes the motion path.

1. Select the object you want to animate and the path you want to use as the motion path.

You cannot convert more than two selected objects.

2. In the Animation panel, click the Convert To Motion Path button .
3. Change the settings in the Animation panel.

Motion preset options

Motion preset options appear in the Animation panel. Click the Properties option to display advanced settings.

Name Specify a name for the animation. Specifying a descriptive name is especially useful when setting up an action that triggers the animation.

Preset Choose from a list of pre-defined motion settings.

Event(s) By default, On Page Load is selected, which means the animated object plays when the page is opened in the SWF file. Choose On Page Click to trigger the animation when the page is clicked. Choose On Click (Self) or On Roll Over (Self) to trigger the animation when the object itself is clicked or moused over, respectively. If you create a button action that triggers the animation, On Button Event is selected. (See Add actions to buttons.) You can specify multiple events to start the animation.

If you select the On Roll Over (Self) event, you can also select Reverse On Roll Off. This option reverses the action of the animation when the mouse moves off the object.

Create Button Trigger Click this button to trigger the animation from an existing object or button. After you click Create Button Trigger , click the object that triggers the animation. The object is converted to a button, if necessary, and the Buttons panel opens.

Duration Specify how much time it takes for the animation to occur.

Play Specify the number of times the animation is played, or select Loop to cause the animation to play repeatedly until it's stopped.

Speed Choose an option to determine whether the animation speed is a steady rate (None), starts slowly and speeds up (Ease In), or slows down at the end (Ease Out).

Note: *The following options are available when Properties is expanded.*

Animate Choose From Current Appearance to use the object's current properties (scale percentage, rotation angle, and position) as the starting point of the animation.

Choose To Current Appearance to use the object's properties as the ending point of the animation. Using this option is especially useful in slide shows. For example, objects that fly in from off the page can appear on the page rather than on the pasteboard, improving the appearance of the printed document.

Choose To Current Location to use the current object's properties as the starting point of the animation and the object's position as the ending point. This option is similar to From Current Appearance, only the object finishes in its current location and the motion path is offset. This option is especially useful for certain presets, such as blurs and fades, to prevent the object from appearing in an undesirable state at the end of the animation.

 *To display the proxy at the end of the motion path, click the Show Animation Proxy at the bottom of the Animation panel.*

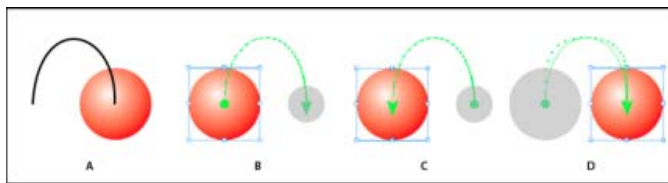

Animate settings

A. Object and path before animation **B.** From Current Appearance **C.** To Current Appearance **D.** To Current Location

Rotate Specify a rotation angle that the object completes during the animation.

Origin Use the proxy to specify the origin point of the motion path on the animated object.

Scale Specify a percentage value to determine whether the object increases or decreases in size during playback.

Opacity Choose an option to determine whether the animation remains solid (None), gradually becomes visible (Fade In), or gradually becomes invisible (Fade Out).

Visibility Select Hide Until Animated or Hide After Animating to make an object invisible before or after playback.

[To the top](#)

Manage motion presets

You can save animation settings as motion presets that you can easily reuse in InDesign. You can also import presets from XML files that can be opened in Flash Professional or shared with other InDesign users.

Save motion presets for reuse

Custom presets appear at the top of the Presets menu in the Animation panel.

1. In the Animation panel, change the settings as needed.
2. Choose Save from the Animation panel menu.

3. Type a name for the preset and click OK.

Delete custom motion presets

Use the Manage Presets dialog box to delete motion presets that you've saved, duplicated, or imported. You cannot delete the motion presets in brackets that were installed with InDesign. When you delete a motion preset, it is deleted both from the Presets menu and from the computer.

1. Choose Manage Presets from the Animation panel menu.
2. Select the preset you want to delete, and click Delete.

Duplicate motion presets

1. Choose Manage Presets from the Animation panel menu.
2. Select the preset you want to duplicate, and click Duplicate.

Save motion presets as XML files

Saving motion presets as XML files is useful if you want to share a motion preset with other InDesign users or open the motion preset in Flash Professional.

When you save a motion preset as an XML file, the motion path is saved, along with the Duration, Speed, Scale, Rotate, and Opacity settings.

1. Choose Manage Presets from the Animation panel menu.
2. Select a preset and click Save As.
3. Specify the name and location of the motion preset, and click Save.

Import motion presets

You can import motion presets that have been exported from either InDesign or Flash Professional as XML files.

1. Choose Manage Presets from the Animation panel menu.
2. Click Load.
3. Double-click the .xml file you want to import.

[To the top](#)

Edit a motion path

When you select an object that has animation, the motion path appears next to the object.

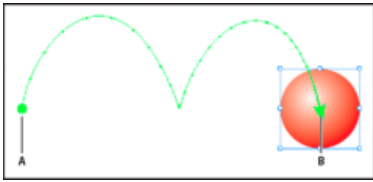

Motion path

A. Starting point **B.** Ending point

- To edit a motion path, do any of the following:
 - Use the Direct Selection tool and the Pen tool to edit a motion path using the same method you use to edit a path. See [Editing paths](#).
 - To create a motion path from an existing path, select a path and an object, and click the Convert To Motion Path button  in the Animation panel.
 - To change the direction of the path, click Properties in the Animation panel, and then choose a setting from the Animate menu. (See [Motion preset options](#).) You can also select the motion path and choose Object > Paths > Reverse Path. If you want to reverse the path without moving the object, remove the animation, reverse the path, and then redo the animation.

[To the top](#)



Use the Timing panel to change the animation order

Use the Timing panel to change the order of when animated objects play. The Timing panel lists the animations on the current spread based on the page event assigned to each animation. For example, you can change one set of animations that occur when the page is loaded, and then change another set of animations that occur when the page is clicked.

Animated objects are listed in the order they were created. Animations listed for the Page Load event occur sequentially by default. Animations listed for the Page Click event are played in sequence each time the page is clicked.

You can change the animation order, have objects play at the same time, and delay animation.

1. Choose Window > Interactive > Timing to display the Timing panel.
2. To determine whether to edit the timing of Page Load or Page Click events, choose an option from the Event menu.

Page Load and Page Click appear only if one or more items are assigned to that event.
3. To edit the timing, do any of the following:
 - To change the animation order, drag items up and down in the list. The top items are animated first.
 - To delay animation, select the item, and specify the number of seconds of delay.
 - To play multiple animated objects together, select the items in the list, and click the Play Together button  to link the items. Shift-click to select a range of items, and Ctrl-click (Windows) or Command-click (Mac OS) to select non-adjacent items.
 - If you decide you don't want one or more linked items to play together, select them and click the Play Separately button .
 - To play links items a specific number of times or to loop them, select all the items that are linked together, and then specify the number of times the animations play back, or select Loop.
 - To change which event triggers the animation, select the item and choose Reassign To On Page Load or Reassign To On Page Click.
 - To remove an item from the currently selected event (such as Page Load or Page Click), choose Remove Item. If the item isn't assigned to any event, it appears in the Unassigned category, which you can choose from the Event menu.

Structuring PDFs

[Adding structure to PDFs](#)

[How tags affect reuse and accessibility](#)

[Understanding and optimizing reflow](#)

[Tag page items](#)

[Label graphics for use with screen-reader software](#)

[Group page items into an Article element](#)

[To the top](#)

Adding structure to PDFs

When you export to Adobe PDF with the Create Tagged PDF option selected in the General area of the Export Adobe PDF dialog box, the exported pages are automatically tagged with a set of structure tags that describe the content, identifying page items such as headlines, stories, and figures. To add additional tags or to fine-tune existing ones before you export, you can use the Tags panel in InDesign. The Structure pane (View > Structure > Show Structure) reflects the changes.

You can improve the accessibility and reuse of Adobe PDF documents by adding tags to the InDesign document before you export. If your PDF documents don't contain tags, Adobe Reader or Acrobat may attempt to automatically tag the document when the user reads or reflows it, but the results may be disappointing. If you do not get the results you want in the exported PDF file, you can use tools in Acrobat 6.0 Professional and later to edit the structure of tagged PDF documents. For the most advanced tools, use Acrobat 9 Professional.

When you apply tags to a document for PDF export, the tags do not control which content is exported to PDF, as is the case with XML export. Instead, the tags give Acrobat more information about the document's structural contents.

Advantages of using tags

By applying tags to your document before exporting to PDF, you can do the following:

- Map InDesign paragraph style names to Acrobat tagged Adobe PDF paragraph styles to create a reflowable PDF file for viewing on handheld devices and other media.
- Mark and hide printing artifacts, text, and images so that they won't appear when reflowed in Acrobat. For example, if you tag a page item as Artifact, the page item will not be displayed when you reflow the contents of a tagged Adobe PDF document on a handheld device, a small display, or a monitor at a large magnification.
- Add alternative text to figures so that the text can be read aloud to the visually impaired with screen-reading software.
- Replace graphic letters, such as ornate drop-caps, with readable letters.
- Provide a title for a set of articles, or group stories and figures into articles.
- Order stories and figures to establish a reading order.
- Recognize tables, formatted lists, and tables of contents. Recognize which content blocks belong to the different stories.
- Include text formatting information such as Unicode values of characters, spacing between words, and the recognition of soft and hard hyphens.

[To the top](#)

How tags affect reuse and accessibility

The content of an Adobe PDF document can be reused for other purposes. For example, you might create an Adobe PDF file of a report with text, tables, and images, and then use various formats to distribute it: for printing or reading on a full-sized monitor, for viewing on a handheld device, for reading out loud by a screen reader, and for direct access through a web browser as HTML pages. The ease and reliability with which you can reuse the content depends on the underlying logical structure of the document.

To make sure that your Adobe PDF documents can be reused and accessed reliably, you must add tags to them. Tagging adds an underlying

organizational structure, or *logical structure tree*, to the document. The logical structure tree refers to the organization of the document's content, such as title page, chapters, sections, and subsection. It can indicate the precise reading order and improve navigation—particularly for longer, more complex documents—without changing the appearance of the PDF document.

For people who are not able to see or decode the visual appearance of documents, assistive technology can access the content of the document reliably by using the logical structure tree. Most assistive technology depends on this structure to convey the meaning of content and images in an alternative format, such as sound. In an untagged document, no such structure exists, and Acrobat must infer a structure based on the reading order choices in the preferences. This method is unreliable and often results in page items read in the wrong order or not read at all.

The tags appear on the Tags tab in Acrobat 6.0 and later, where they are nested according to the relationship definitions for the tagged elements. You cannot edit tags in Acrobat Standard. If your work requires you to work directly with tags, you should upgrade to Acrobat 9 Professional. For more information, see Acrobat Help.

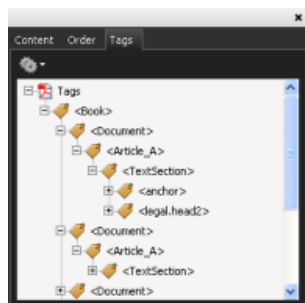

Logical structure tree on the Tags tab in Acrobat 9

Note: Tags used in Adobe PDF files can be compared to tags in HTML and XML files. To learn more about basic tagging concepts, see any of the many references and text books available in bookstores, in libraries, and on the Internet.

[To the top](#)

Understanding and optimizing reflow

You can *reflow* a PDF document to read it on handheld devices, smaller displays, or standard monitors at large magnifications, without having to scroll horizontally to read each line.

When you reflow an Adobe PDF document, some content carries into the reflowed document and some doesn't. In most cases, only readable text reflows into the reflowed document. Readable text includes articles, paragraphs, tables, images, and formatted lists. Text that doesn't reflow includes forms, comments, digital signature fields, and page artifacts, such as page numbers, headers, and footers. Pages that contain both readable text and form or digital signature fields don't reflow. Vertical text reflows horizontally.

As an author, you can optimize your PDF documents for reflow by tagging them. Tagging ensures that text blocks reflow and that content follows the appropriate sequences, so readers can follow a story that spans different pages and columns without other stories interrupting the flow. The reading order is defined by the structure tree, which you can change in the Structure pane.



Tag page items

You can tag text frames and graphics automatically or manually. After you tag page items, you can use the Structure pane to change the order of your page by dragging elements to a new location within the hierarchy. If you change the order of the elements in the Structure pane, these changes are passed on to the Adobe PDF file. The order of the elements becomes useful when the PDF file is saved from Acrobat as an HTML or XML file. The order is also useful when you export an InDesign document for Dreamweaver (XHTML) or Digital Editions (EPUB) format.

Tag page items automatically

When you choose the Add Untagged Items command, InDesign adds tags to the Tags panel, and applies the Story and Figure tags to certain untagged page items. The Story tag is applied to any untagged text frames, and the Figure tag is applied to any untagged graphics. You can then manually apply other tags to sections of text. However, automatically tagging page items does not guarantee that the items will be structured accordingly in the exported PDF file.

1. Choose Window > Utilities > Tags to display the Tags panel.
2. Choose View > Structure > Show Structure to display the Structure pane, to the left of the Document window.
3. Choose Add Untagged Items from the Structure pane menu.



Tags in the Structure pane and Tags panel

Tag page items manually

1. Choose Window > Utilities > Tags to display the Tags panel.
2. Choose View > Structure > Show Structure to display the Structure pane, to the left of the Document window.
3. Choose Add Untagged Items from the Structure pane menu.
4. Select a page item in the document.

5. Select a tag in the Tags panel. Note the following suggested uses for certain imported tags:

Artifact The Artifact tag lets you hide page items, such as page numbers or unimportant objects, when viewing the exported PDF file in Reflow view, which displays only tagged items; see your Adobe Acrobat documentation. This is especially useful for viewing PDF files on a handheld device or in other PDF readers.

Cell Use this tag for table cells.

Figure Use this tag for placed graphics. The Figure tag is applied to all untagged graphics placed in your document when you choose Add Untagged Items.

Paragraph tags (P, H, H1–H6) These tags have no effect on the exported PDF text when viewed in Reflow view. However, they can be useful in some situations when exporting a PDF file to HTML format.

Story structure tag (PDF)Story Use this tag for stories. The Story tag is applied to all untagged text frames when you choose Add Untagged Items. For example, suppose you have an InDesign document formatted with three paragraph styles: Head1, Head2, and Body. First, map these paragraph styles to the H1, H2, and P tags, respectively. Next, export to PDF. Finally, when you export the PDF document to HTML or XML in Acrobat, the paragraphs tagged as H1, H2, and P will display appropriately (such as with large bold letters in H1) in a web browser. For information on exporting the PDF document to HTML or XML, see your Adobe Acrobat documentation.

[To the top](#)

Label graphics for use with screen-reader software

If you want screen readers to describe graphical elements that illustrate important concepts in the document, you must provide the description. Figures and multimedia aren't recognized or read by a screen reader unless you add alternate text to the tag properties.

The Alt text attribute lets you create alternate text that can be read in lieu of viewing an illustration. ActualText is similar to Alt text in that it appears in lieu of an image. The ActualText attribute lets you substitute an image that is part of a word, such as when a fancy image is used for a drop cap. In this example, the ActualText attribute allows the drop cap letter to be read as part of the word.

When you export to Adobe PDF, the Alt text and Actual Text attribute values are stored in the PDF file and can be viewed in Acrobat 6.0 and later. This alternate text information can then be used when the PDF file is saved from Acrobat as an HTML or XML file. For more information, see your Adobe Acrobat documentation.

1. If necessary, choose View > Structure > Show Structure to display the Structure pane, and choose Window > Utilities > Tags to display the Tags panel.
2. Choose Add Untagged Items from the Structure pane menu.
3. To make sure the image is tagged as Figure, select the image, and then select Figure in the Tags panel.
4. Select the Figure element in the Structure pane, and then choose New Attribute from the Structure pane menu.
5. For Name, type either **Alt** or **ActualText** (this feature is case-sensitive).
6. For Value, type the text that will appear instead of the image.

[To the top](#)

Group page items into an Article element

Use the Structure pane to logically group page items into an Article element. For example, if a set of stories spans multiple pages, you can create an umbrella element that will contain these stories in a single group. These umbrella elements are called *structural elements*. You can also name your grouped articles.

Note: You cannot tag grouped page items.

- To group page items, select New Element from the Structure pane menu, select the Article element in the Tags panel, and then drag page elements underneath it in the Structure pane.
- To name grouped items, right-click the Article element in the Structure pane and choose New Attribute. For Name, type **Title**. For Value, type the name of the article you want to use.

Adobe also recommends

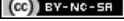
 Twitter™ and Facebook posts are not covered under the terms of Creative Commons.

[Legal Notices](#) | [Online Privacy Policy](#)

Page transitions

[Apply page transitions](#)

[Clear transitions](#)

[Viewing page transitions in a PDF](#)

Page transitions display a decorative effect such as a dissolve or wipe when you're turning pages in a document that is exported to SWF or PDF format. You can apply different transitions to different pages, or you can apply a single transition to all the pages. Page transitions are especially useful when you create a slideshow in PDF or SWF format.

[To the top](#)

Apply page transitions

You can apply page transitions to individual spreads or to all spreads in the document. Page transitions appear when you export an InDesign document to PDF or SWF format. You cannot apply transitions to different pages within the same spread or to master pages.



Page turn transition in SWF file. Click a corner of the image to view transition.

1. In the Pages panel, select the spreads to which you want to apply the page transition.
Make sure the spread is selected, not simply targeted. The numbers below the pages in the Pages panel should be highlighted.
2. To display the Page Transitions panel, choose Window > Interactive > Page Transitions.
3. Choose a Transition from the Transition menu.
 *Hold the mouse pointer over the thumbnail to view an animated preview of the selected transition.*

You may wonder whether it's necessary to select the Page Turn (SWF Only) transition to create a page curl effect in SWF file. It isn't necessary to apply this transition to turn pages manually in the SWF file. If you select the Include Interactive Page Curl option in the Export SWF dialog box, you can either turn the pages manually by dragging a corner in the exported SWF file, or you can use arrow keys or navigation buttons to activate whatever page transition you select for that page.

4. Customize the transition as desired by choosing options from the Direction and Speed menus.
5. (Optional) To apply the selected transition to all spreads currently in the document, click the Apply To All Spreads icon , or choose Apply To All Spreads from the Page Transitions panel menu.

6. (Optional) Select a different spread in the Pages panel, and apply a different page transition.

When you apply a page transition to a spread, a Page Transition icon  appears next to the spread in the Pages panel. You can hide these icons in the Pages panel by deselecting the Page Transitions option in the Panel Options dialog box.

 *To preview the page transitions, export the document either to PDF or SWF format.*

[To the top](#)

Clear transitions

- In the Pages panel, select the spread from which you want to clear the transition, and then choose None from the Transition menu in the Page Transition panel.
- To remove transitions from all spreads, choose Clear All from the Page Transitions panel menu.

[To the top](#)

Viewing page transitions in a PDF

To include page transitions when you export the PDF document, select a page transition from Page Transitions menu in the Export to Interactive PDF dialog box.

To see page transitions in the exported PDF, place the PDF in Full Screen Mode by pressing Ctrl+L (Windows) or Command+L (Mac OS) in Adobe Acrobat or Adobe Reader. Press Esc to exit from Full Screen Mode.

Adobe also recommends

- [Exporting to Adobe PDF](#)

 Twitter™ and Facebook posts are not covered under the terms of Creative Commons.

[Legal Notices](#) | [Online Privacy Policy](#)

Movies and sounds

[Add movies and sound files to documents](#)
[Resize movie objects, posters, or frames](#)
[Relink legacy media files](#)

[To the top](#)

Add movies and sound files to documents

Movies and sound clips you add to a document can be played when the document is exported to Adobe PDF or SWF, or when you export the document to XML and repurpose the tags.

You can import video files in Flash Video format (.FLV and .F4V), H.264-encoded files (such as MP4), and SWF files. You can import audio files in MP3 format. Media file types such as QuickTime (.MOV), AVI, and MPEG are supported in exported interactive PDF files but not in exported SWF or FLA files. We recommend that you use file formats such as FLV, F4V, SWF, MP4, and MP3 to take full advantage of the rich media support offered in Acrobat 9, Adobe Reader 9, and Adobe Flash Player 10 or later.

Keep track of the media files you add to an InDesign document during the production cycle. If you move a linked media clip after adding it to the document, use the Links panel to relink it. If you send the InDesign document to another person, include any media files you add.

Add a movie or a sound file

1. Choose File > Place, and then double-click the movie or sound file. Click where you want the movie to appear. (If you drag to create the media frame, the movie boundary may appear cropped or skewed.)

When you place a movie or sound file, a media object appears in a frame. This media object links to the media file. You can resize the media object to determine the size of the play area.

If the center point of the movie appears outside the page, the movie is not exported.

2. Use the Media panel (choose Window > Interactive > Media) to preview a media file and to change settings.

3. Export the document to Adobe PDF or SWF format.

If you export to Adobe PDF, choose the Adobe PDF (Interactive) option, not Adobe PDF (Print). See [Create interactive documents for PDF](#).

Change movie settings

Use the Media panel to change movie settings.

1. Select the movie object in the document.
2. In the Media panel, do any of the following:

Play On Page Load Play the movie when someone turns to the page on which the movie is located. If other page items are set to play on page load, use the Timing panel to determine the order.

Loop Play the movie repeatedly. If the source file is a Flash Video format, looping works only in exported SWF files, not PDF files.

Poster Specify the type of image that you want to appear in the play area. See [Poster options](#).

Controller If the movie file is a Flash Video (FLV or F4V) file or an H.264-encoded file, you can specify prefabricated controller skins that let users pause, start, and stop the movie using a variety of methods. If you select Show Controller On Rollover, the controls appear when the mouse pointer hovers over the media object. Use the Preview panel to preview the selected controller skin.

If the movie file is a legacy file (such as .AVI or .MPEG), you can choose None or Show Controller, which displays a basic controller that lets users pause, start, and stop the movie.

SWF files you place may have their own controller skins. Use the Preview panel to test the controller options.

Navigation Points To create a navigation point, advance the video to a specific frame, and then click the plus sign icon. Navigation points are useful when you want to play a video at a different starting point. When you create a button that plays a video, you can use the Play From Navigation Point option to play the video starting at any navigation point you add.

Change sound settings

Use the Media panel to change sound settings.

1. Select the sound object in the document.
2. In the Media panel, do any of the following:

Play On Page Load Play the sound file when someone turns to the page on which the sound object is located. If other page items are set to play on page load, use the Timing panel to determine the order.

Stop On Page Turn Stop playing the MP3 sound file when someone turns to a different page. If the audio file is a non-MP3 file, this option is dimmed.

Loop Play the MP3 sound repeatedly. If the source file is a non-MP3 file, this option is dimmed.

Poster Specify the type of image that you want to appear in the play area. See [Poster options](#).

Poster options

A *poster* is the image that represents a media clip. Each movie or sound can appear with or without a poster. If the poster in InDesign is larger than the movie, the poster is clipped to the size of the movie in the exported PDF or SWF file. Specify any of the following types of poster images in the Media panel:

None Shows no poster for the movie or sound clip. This option is useful if you want the movie or sound clip to not be visible on the page. For example, you may want the media to be played only when you turn the page, or you may want a more complex design beneath the movie to show instead of the poster.

Standard Displays a generic movie or sound poster that isn't based on the contents of the file.

 *To use a different standard poster, save an image as StandardMoviePoster.jpg or StandardSoundPoster.jpg, and replace the existing file of the same name. This file is located in the Presets/Multimedia folder in the application folder.*

From Current Frame Select this option to use the current frame displayed in the preview area of the Media panel. To select a different frame, advanced the preview slider and click the icon to the right of the Poster menu. This option is not available with legacy movie formats such as AVI

and MPEG.

Choose Image Lets you select an image to use as the poster. Double-click the image you want to use. You can select bitmap graphics, not vector graphics, for posters.

From Video This option is selected for converted CS4 documents that have media clips set to a specific frame.

Change media settings for interactive PDF files

1. Choose PDF Options from the Media panel menu.
2. Specify the following options, and click OK.

Description Type a description that appears if the media file cannot be played in Acrobat. This description also acts as alternative text for visually impaired users.

Play Video In Floating Window Play the movie in a separate window. If you select this option, specify the size ratio and position on the screen. Increasing the size of the floating window may reduce image quality. The floating window scale is based on the size of the original movie, not the size of the scaled movie in the document layout. This option is not available for SWF files or audio files.

Place a video file from a URL

Place a video file from a valid URL to play the streaming video in the exported PDF or SWF file. The video must be a valid Flash Video file (FLV or F4V) or H.264-encoded file (such as MP4).

1. Select an empty frame or a video object containing a video you want to replace.
2. Choose Video From URL from the Media panel menu.
3. Specify the URL and click OK.

[To the top](#)

Resize movie objects, posters, or frames

When you add a movie to the InDesign document, the movie object and poster appear in a frame. When you export to PDF, the movie object's boundary determines the size of the movie in the PDF document, not the frame size or poster size.

For best results, keep the poster size and dimension the same as the movie. If you apply a clipping path or resize the image, the exported PDF document may not include these changes.



Movies are displayed in the topmost layer of the PDF document. If you overlay a movie with another object in InDesign, that object appears beneath the movie in the exported PDF.

 *If you want the PDF document to include a play area with feathering or other effects that may not export well when applied to a poster, consider using a placed image for the play area, and then place a movie (without a poster) on top of the placed image.*



Resizing movie object

A. Poster **B.** Movie object **C.** Frame

- Do any of the following:
 - To resize the movie object, poster, and frame, use the Scale tool  and drag one of the corner handles (hold down Shift to maintain proportions).
 - To resize only the frame, use the Selection tool  to drag a corner handle.
 - To resize the poster or media object, use the Direct Selection tool  to select the poster. Switch to the Selection tool, and then drag a corner handle.

 You can also use the Fitting commands (*Object > Fitting*) to resize a poster within a frame.

[To the top](#)

Relink legacy media files

The FLV and F4V video formats and MP3 audio formats work best in InDesign for exporting interactive documents. While video formats such as MOV, AVI, and MPG can be exported to PDF, they cannot be exported to Flash-based formats such as SWF.

Use Adobe Media Encoder to convert video files to FLV, F4V, or MP4 format. Adobe Media Encoder does not convert audio file formats to MP3, but you can use an application such as Apple iTunes to do so.

1. Open Adobe Media Encoder, add the video files you want to convert, and convert them to FLV or F4V format.

For more information, see Adobe Media Encoder Help.

2. Do any of the following actions:

- Place the media file in an InDesign document. See [Add movies and sound files to documents](#).
- If the video files have already been placed in an InDesign document, use the Links panel to relink the files to their new versions. See Update, restore, and replace links.

Adobe also recommends

- Export to PDF for printing

 Twitter™ and Facebook posts are not covered under the terms of Creative Commons.

[Legal Notices](#) | [Online Privacy Policy](#)

Forms | CC, CS6

What's covered

[Forms workflow](#)

[Add a form field](#)

[Specify tab order](#)

[To the top](#)

Forms workflow

You can design forms in InDesign and export them directly to PDF. InDesign now supports form fields and additional form actions. The Buttons and Forms library (Window > Interactive > Buttons and Forms) has form items that you can use to design interactive forms.

Using InDesign you can create simple forms within InDesign, without needing to touch up the PDF document in Acrobat after publishing. You can add simple form elements within the document pages. Common field types such as text fields, radio buttons, check boxes, or signatures are supported. You can also add actions to submit the form by email or to print it.

In addition to the basic design, you can also use creative capabilities in InDesign to add a designer touch to your form.

- Add solid strokes and fills to the PDF form fields.
- Add custom On, Off, and Hover states for buttons, check boxes, and radio buttons.
- Specify font size for text input fields.

For example, to collect credit card information, you could use credit card icons as radio buttons, with a different image for the selected state.

For advanced form workflows, you can export the basic form and then continue editing it in Adobe Acrobat.

[To the top](#)

Add a form field

Use the Buttons and Forms panel to add form fields to the layout. The procedures to add interactive form fields are the same as adding buttons so that you don't have to learn new procedures. You can create a form that works with Adobe Reader or Adobe Acrobat. Using InDesign, you can create some cool forms that you can't ordinarily using Acrobat.

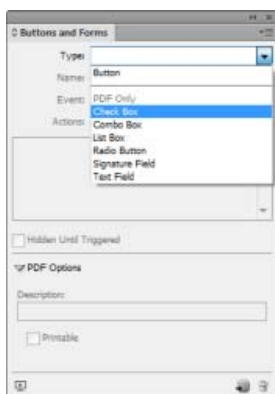

Buttons and Forms panel

1. Place a frame at the location where you want to place the form field.
2. Open the Buttons and Forms panel (Windows > Interactive > Buttons and Forms).
3. Select the frame and from the Type list choose a form element type. Alternatively, right-click a frame and choose Interactive > Convert to [...]

4. Enter a name for the form field. To create a radio button group, all the individual buttons must have the same name.
5. Choose an event and add actions to associate with it. Actions such as Clear Form, Print Form, and Submit Form have been added. In the Submit Form action specify the URL as "mailto:xyz@example.com".
6. For a radio button, check box, or buttons: set appearance attributes for different states. InDesign adds default graphics for the various states, but you can add your own.
7. Specify PDF options:
 - Description - Entered value is displayed as the tool tip and is used for creating accessible forms
 - Button Value - this value corresponds to the export value in Acrobat and can also be used to identify a radio button in a group in a accessible form.

[To the top](#)

Specify tab order

To create user friendly and accessible forms, it is necessary to assign a usable tab order. Users can navigate through the form fields without using a pointing device. Pressing the Tab key shifts the focus to the next logical field.

There are two methods of specifying a tab order in a tagged PDF:

- Use the Articles panel (Windows > Article) to specify a custom tab order
- Choose Object > Interactive > Set Tab Order.

Use Articles to specify tab order

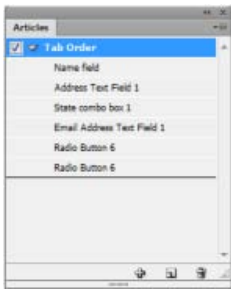

Use the Articles panel to specify tab order

1. Open the Articles panel (Window > Articles).
2. Drag the form fields to the Articles panel.
3. In the articles panel, drag to reorder the fields in the required order.

 *To enable screen readers to use the specified order, from the Articles panel menu, enable Use for Reading Order in Tagged PDFs. Remember to enable the Create Tagged PDF option while exporting the PDF.*

Use Structure to specify tab order

1. Choose Objects > Interactive > Set Tab Order.
2. Click Move Up or Move Down to arrange the items in the desired tab order.

While exporting to interactive PDF, enable Use Structure for Tab Order in the PDF Export dialog box.

See also

- [Working with Articles](#)
- [Export to interactive PDF options](#)



Twitter™ and Facebook posts are not covered under the terms of Creative Commons.

[Legal Notices](#) | [Online Privacy Policy](#)

Dynamic PDF documents

[Create interactive documents for PDF](#)
[Creating PDF forms \(CS5.5 and CS5\)](#)
[Preview interactive documents](#)
[Use Presentation Mode](#)

Creating a dynamic PDF document is a good way to create an interactive slideshow. You can create interactive documents with buttons, movies and sound clips, hyperlinks, bookmarks, and page transitions. You can also set up documents in InDesign that can be converted to forms in Acrobat.

[To the top](#)

Create interactive documents for PDF

You can export Adobe PDF documents that include the following interactive features.

Bookmarks Bookmarks you create in the InDesign document appear in the Bookmarks tab on the left side of the Adobe Acrobat or Adobe Reader window. Each bookmark jumps to a page, text, or graphic in the exported PDF file. See [Bookmarks](#).

Movies and sound clips You can add movies and sound clips to a document, or you can link to streaming video files on the Internet. These movies and sound clips can be played back in the exported PDF file. See [Movies and sounds](#).

Hyperlinks In an exported PDF document, clicking a hyperlink jumps to another location in the same document, to a different document, or to a website. See [Hyperlinks](#).

Cross-references A cross-reference refers readers from one part of your document to another in the exported PDF file. Cross-references are especially useful in user guides and reference manuals. When a document with cross-references is exported to PDF, the cross-references act as interactive hyperlinks. See [Cross-references](#).

Page transitions Page transitions apply a decorative effect, such as a dissolve or wipe, when you turn the page in the exported PDF while in Full Screen Mode. See [Page transitions](#).

1. Choose File > Export.
2. Specify a name and location for the file.
3. For Save As Type (Windows) or Format (Mac OS), choose Adobe PDF (Interactive), and then click Save.
4. Specify options in the Export To Interactive PDF dialog box, and then click OK.

Export to interactive PDF options

The following options appear in the Export To Interactive PDF dialog box.

Pages Indicate whether all pages in the document, or a page range is included. If you select Range, specify a page range, such as 1–7, 9 to

print pages 1 through 7 and 9. See Specifying pages to print.

View After Exporting Opens the newly-created PDF file in the default PDF viewing application.

Embed Page Thumbnails Embeds a thumbnail preview for each page in the PDF, increasing the file size. Deselect this setting when users of Acrobat 5.0 and later will view and print the PDF; these versions generate thumbnails dynamically each time you click the Pages panel of a PDF.

Create Acrobat Layers Saves each InDesign layer as an Acrobat layer within the PDF. The layers are fully navigable, which allows users of Acrobat 6.0 and later to generate multiple versions of the file from a single PDF.

Create Tagged PDF During export, automatically tags elements in the story based on a subset of the Acrobat tags that InDesign supports. This includes recognition of paragraphs, basic text formatting, lists, and tables. (You can also insert and adjust tags in the document before exporting to PDF. See Adding structure to PDFs.)

Use Structure for Tab Order During export, uses the Tab Order specified using Object > Interactive > Set Tab Order. This option is only available for tagged PDFs.

View Initial view settings of the PDF when it's opened.

Layout Initial layout of the PDF when it's opened.

Presentation Select Opens In Full Screen Mode to display the PDF in Adobe Acrobat or Adobe Reader without menus or panels displayed. To advance the pages automatically, select Flip Pages Every and specify the number of seconds between page turns.

Page Transitions Specify one page transition to apply to all pages during export. If you use the Page Transitions panel to specify transitions, choose the From Document option to use those settings.

Buttons And Media Select Include All to allow movies, sounds, and buttons to be interactive in the exported PDF file. Select Appearance Only to include the normal state of buttons and the video posters as static elements.

Compression Choose JPEG (Lossy) to remove image data and possibly reduce image quality. However, file size is reduced with a minimal loss of information. Choose JPEG 2000 (Lossless) to export the file without lossy compression. Choose Automatic to let InDesign determine the best quality for color and grayscale images.

JPEG Quality Specifies the amount of detail in the exported image. The higher the quality, the larger the file size. This option is dimmed if you choose JPEG 2000 (Lossless) for Compression.

Resolution Specify the resolution of bitmap images in the exported PDF. Choosing a high resolution is especially important to allow viewers to zoom in on pixel-based content within your exported PDF. Choosing a high resolution can significantly increase the file size.

[To the top](#)

Creating PDF forms (CS5.5 and CS5)

Although InDesign does not provide tools for adding form fields, Adobe Acrobat does. You can create a form in InDesign that includes placeholders for fields such as radio buttons, check boxes, and text fields. Then you can export to PDF, and use Acrobat to convert the placeholders into form fields.

1. In InDesign, create the document you want to use for the form. Use tables and text boxes to create the placeholders for the fields.

You can also add interactive buttons in InDesign.

2. Export the document to Adobe PDF.

3. Start the form wizard to convert the placeholders into form fields. Use the form tools to add and edit the form. For more information, see the Adobe Acrobat documentation.

- In Acrobat X, choose Tools > Forms > Create to start the form wizard.
- In Adobe Acrobat 9, choose Forms > Start Form Wizard.

Additional Resources

Gabriel Powell provides a video tutorial about creating a PDF form design in InDesign and finishing it in Adobe Acrobat at [InDesign and Acrobat Forms Workflow](#).

The Acrobat team provides an article on [Designing forms for auto field detection in Adobe Acrobat](#).

Michael Murphy provides a video tutorial about creating forms at [Acrobat Friendly Form Design](#).

Bob Bringhurst provides an article about designing forms at [Creating PDF Forms in InDesign](#).



[To the top](#)

Preview interactive documents

Use the Preview panel preview interactivity and animation of the current selection, the current spread, or the entire document. You can resize, dock, or float the Preview panel, or move it to a second monitor.

1. Choose Window > Interactive > Preview.

2. To preview the interactivity and animation, do any of the following actions:

- Click the Set Preview Selection Mode button  to preview the current selection.
- Click the Set Preview Spread Mode button  to preview the current spread.
- Click the Set Preview Document Mode button  to preview the current document.

3. Click the Play Preview button  to preview the selection, spread, or document. If necessary, click interactive items such as buttons in the Preview panel to test them.

If you're previewing the document, you can click the Go To Previous Page and Go To Next Page arrows at the bottom of the panel to move to different pages.

 *If you edit your document, you can refresh the preview by clicking the Play Preview button in the Preview panel.*

Preview the document in a web browser

1. Choose Test In Browser from the Preview panel menu.

2. Click the interactive items in you document to test them.

Edit Preview settings

1. Choose Edit Preview Settings from the Preview panel menu.

The Preview Settings dialog box shows the current settings of the Export SWF dialog box.

2. Edit the settings as needed. See SWF export options.

[To the top](#)

Use Presentation Mode

Presentation Mode displays the active InDesign document as a presentation. In Presentation Mode, the application menu, panels, guides, and frame edges are hidden. The background area has a dark color by default in case your document size is a different proportion from your current monitor dimensions.

Presentation Mode is a helpful companion feature to the Adobe Connect feature. You can start a web meeting by using the File > Share My Screen command. Once the screen sharing has started, you can put your InDesign document into Presentation Mode.

1. Choose View > Screen Mode > Presentation.
2. Use any of the following keystrokes.

Action	What it does
Mouse click, Right arrow, or Page Down	Next Spread
Shift-click, Right-click, Left Arrow, or Page Up	Previous Spread
Esc	Exit Presentation Mode
Home	First Spread
End	Last Spread
B	Change background color to black
W	Change background color to white
G	Change background color to gray

 You cannot edit the document in Presentation Mode. However with a dual screen monitor, you can have two windows open on the same document and put one of them into Presentation Mode. This approach lets you edit the document in the window set to Normal view and immediately see the results in the window set to Presentation Mode.

Adobe also recommends

- [Exporting to Adobe PDF](#)

 Twitter™ and Facebook posts are not covered under the terms of Creative Commons.

[Legal Notices](#) | [Online Privacy Policy](#)

Buttons

- [Create buttons](#)
- [Make buttons interactive](#)
- [Change button appearance for rollover and clicking](#)
- [Create multi-state objects](#)
- [Create button hot spots](#)
- [Set the button tab order](#)

[To the top](#)

Create buttons

You can create buttons that perform an action when the document is exported to SWF or PDF format. For example, you can create a button that jumps to a different page or opens a website.



Button set up to play movie in exported PDF

When you create a button, you can do the following:

- Use the Buttons panel to make the buttons interactive. When a user clicks a button in the exported SWF or PDF file, an action is performed. See [Make buttons interactive](#).
- Use the Appearance section of the Buttons panel to define the appearance the button takes in response to certain mouse actions. See [Change button appearance for rollover and clicking](#).
- Use the Object States panel to create multi-state objects. See [Create multi-state objects](#).
- Create a “hot spot” or “hot link” effect that displays an image when the button is moused over or clicked. See [Create button hot spots](#).

 *When working on buttons and designing dynamic documents, select the Interactivity workspace.*

Create a button

1. Use the Pen tool or a drawing tool, such as the Rectangle tool or Ellipse tool, to draw the button shape. If necessary, use the Type tool to add text to the button, such as “Next” or “Purchase.”

 *If you're creating navigation buttons (such as Next Page or Previous Page) that appear on multiple pages, add them to a master page so that you don't have to re-create buttons on every document page. These buttons appear on all document pages to which the master is applied.*

2. Use the Selection tool  to select the image, shape, or text frame that you want to convert.

You cannot convert a movie, sound, or poster to a button.

3. Click the Convert Object To A Button icon  in the Buttons panel (choose Window > Interactive > Buttons). Or, choose Object > Interactive > Convert to Button.
4. In the Buttons panel, do any of the following:
 - In the Name text box, specify a name for the button to distinguish it from other buttons you create.
 - Specify one or more actions for the button to determine what happens when the button is clicked in the exported PDF or SWF file. See [Make buttons interactive](#).
 - Activate additional appearance states and change their appearance to determine what the button looks like when you use the mouse to roll over the button or click it in the exported PDF or SWF file. See [Change button appearance for rollover and clicking](#).
5. Use the Preview panel (Window > Interactive > Preview) to test the button before you export the document to interactive PDF or SWF.

Add a button from the Sample Buttons panel

The Sample Buttons panel includes a number of pre-created buttons that you can drag into your document. These sample buttons include effects such as gradient feathers and drop shadows, with a slightly different appearance for the Rollover appearance. The sample buttons are also assigned actions. For example, the sample arrow buttons are preset with Go To Next Page or Go To Previous Page actions. You can edit these buttons to suit your needs.

The Sample Buttons panel is an object library. As with any object library, you can add buttons to the panel and remove ones you don't want to use. (See [Use object libraries](#).) The sample buttons are stored in the ButtonLibrary.indl file, which is located in the Presets/Button Library folder in the InDesign application folder.

1. Choose Sample Buttons from the Buttons panel menu to open the Sample Buttons panel.
2. Drag a button from the Sample Buttons panel to the document. If you want navigation buttons to appear on every page, add the buttons to a master page.
3. Select the button using the Selection tool, and then edit the button as necessary using the Buttons panel.

While editing the sample buttons, keep the following in mind:

- If you add text to a button, remember to copy and paste the text from the Normal button state to the Rollover button state. Otherwise, the text you add does not appear when the mouse rolls over the button in the PDF or SWF file.
- You can resize buttons. If you drag a pair of Next Page/Previous Page arrow buttons, resize the first button, and then select the second button, and choose Object > Transform Again > Transform Again.

 Use the Preview panel to test the button.

Convert a button to an object

When you convert a button to an object, the contents of the button remain on the page without the button properties. Any content associated with the button's other states are also removed.

1. Use the Selection tool  to select the button.
2. Choose Object > Interactive > Convert To Object.

Make buttons interactive

You can create, edit, and manage interactive effects in InDesign. When the document is exported to Adobe PDF or SWF, these interactive actions can be active.

For example, suppose you want to create a button that causes a sound to play in a PDF document. You can place the sound file in an InDesign document, and then create a button that causes the sound to play when you click the button in the PDF document.

In this example, clicking the mouse button is the *event*, and playing the sound is the *action*.

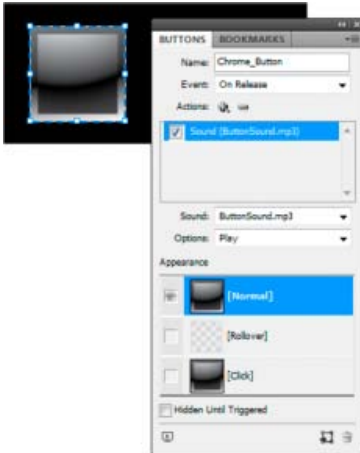



This button is set to play a sound when the mouse button is released.

Note: Some actions are supported in both PDF and SWF files, and some actions are supported only in PDF or SWF. When choosing an action, avoid choosing a PDF-only action if you're exporting to SWF or a SWF-only action if you're exporting to PDF.

Add actions to buttons

You can assign actions to different events. For example, in an exported PDF file, you can specify a sound to play when the mouse pointer enters the button area, and a movie to play when the mouse button is clicked and released. You can also assign multiple actions to the same event. For example, you can create an action that plays a movie and sets the view zoom to Actual Size.

1. Use the Selection tool  to select the button you created.
2. In the Buttons panel, choose an event, such as On Release, that determines how actions are activated.
3. Click the plus sign button  next to Actions, and choose the action to assign to the event.
4. Specify the settings of the action.

For example, if you choose Go To First Page, specify the zoom. If you choose Go To URL, specify the web page address. Some actions, such as Go To Next View, do not have additional settings.

5. If necessary, continue to add as many actions as needed to any event.

 To test the button, export the document to PDF or SWF, and view the exported file. If you're exporting to PDF, make sure that the Interactive Elements option is selected. If you're exporting to SWF, make sure that Include Buttons is selected.

Event types

Events determine how actions are activated in buttons when the document is exported to Adobe PDF or SWF. (In Acrobat, events are called *triggers*.)

On Release When the mouse button is released after a click. This is the most commonly used event, because it gives the user one last chance to drag the cursor off the button and not activate the action.

On Click When the mouse button is clicked (without being released). Unless you have a specific reason for using On Click, it's preferable to use On Release so that users have a chance to cancel the action.

On Roll Over When the mouse pointer enters the button area defined by the button's bounding box.

On Roll Off When the mouse pointer exits the button area.

On Focus When the button in a PDF file receives focus, either through a mouse action or pressing the Tab key.

On Blur When the focus moves to a different button or form field in the PDF file.

Action types

When you create an action, you indicate what happens when the specified event occurs—usually when someone clicks the button. You can assign the following actions to occur when the event type is activated:

Go To Destination Jumps to the specified text anchor created using the Bookmarks or Hyperlinks panel. See [Create jumps to text anchors](#).

Go To First/Last/Next/Previous Page Jumps to the first, last, previous, or next page in the PDF or SWF file. Select an option from the Zoom menu to determine how the page is displayed.

Go To URL Opens the web page of the specified URL.

Show/Hide Buttons Toggles between showing and hiding specified buttons in the exported PDF or SWF file. For example, if you want one button to appear when another button is moused over, you can hide the target button until it's triggered and create an action that displays the hidden button on rollover. See [Display a different button on rollover](#).

Video Lets you play, pause, stop, or resume the selected movie. Only movies that have been added to the document appear in the Video menu.

Sound Lets you play, pause, stop, or resume the selected sound clip. Only sound clips that have been added to the document appear in the Sound menu.

Animation (SWF) Lets you play, pause, stop, or resume to selected animation. Only animations that have been added to the document appear in the Animation menu.

Go To Page (SWF) Jumps to the page in the SWF file you specify.

Go To State (SWF) Jumps to a specific state in a multi-state object. For example, if a multi-state object includes several different images as states, you can use this action to display a particular image.

Go To Next/Previous State (SWF) Jumps to the next or previous state in a multi-state object. These options are especially useful for clicking through a slideshow. See [Create multi-state objects](#).



Go To Next View (PDF) Jumps to a page after going to the previous view. In the same way that a Forward button is available in a web browser only after someone clicks the Back button, this option is available only if the user has jumped to a previous view.

Go To Previous View (PDF) Jumps to the most recently viewed page in the PDF document, or returns to the last used zoom size.

Open File (PDF) Launches and opens the file that you specify. If you specify a file that is not PDF, the reader needs the native application to open it successfully. Specify an absolute pathname (such as C:\docs\sample.pdf).

View Zoom (PDF) Displays the page according to the zoom option you specify. You can change the page zoom level (such as Actual Size), the page layout (such as Continuous - Facing), or the rotation orientation.

Edit or delete button actions

1. Use the Selection tool  to select the button.
2. In the Buttons panel, do any of the following:
 - To deactivate actions, deselect the check box next to the item. Deactivating events and actions can be useful for testing purposes.
 - To change the order, drag and drop actions.
 - To delete an action, select the action in the list box, and click the Delete Selected Action button .
 - To edit an action, choose the event to which the action is assigned, select the action in the list box, and change the settings. If you need to replace a action for an existing event, delete the action, and then add the new action to the event.

Create jumps to text anchors

If you create a text anchor in an InDesign document, you can cause a button to jump to that anchor, even if it's in another InDesign document. Use the Bookmarks panel and Hyperlinks panel to add text anchors. You cannot create jumps from buttons to bookmarks that aren't text anchors.

Note: If you set a hyperlink destination to a button, the hyperlink will have no effect in the exported PDF or SWF document.

1. Use the Selection tool  to select the button.
2. In the Buttons panel, choose the event such as On Release that will trigger the jump.
3. Click the plus sign button next to Actions, and choose Go To Destination.
4. Select one of the open InDesign documents from the Documents menu, or click the folder icon to the right of the menu and specify the file.
5. Specify an anchor that was created using the Bookmarks panel or Hyperlinks panel.
6. Select an option from the Zoom menu to determine how the page is displayed.

Note: If you specify an anchor in a different document, remember to export that target document to PDF, and use the same filename as the InDesign document, replacing the INDD extension with PDF. Also, store the PDF documents in the same folder to make sure that the links remain valid in Acrobat and Reader.

[To the top](#)

Change button appearance for rollover and clicking

A button consists of a group of individual objects that each represent a button appearance (sometimes called a “state”). Each button can have as many as three appearances: Normal, Rollover, and Click. In the exported file, the Normal appearance is used unless the mouse pointer moves into the area (Rollover) or the mouse button is clicked on the button area (Click). You can make each appearance different to provide visual feedback.

By default, any button you create is defined with the Normal appearance containing the button’s text or image. When you activate a new appearance, the Normal appearance is copied. To distinguish an appearance from the others, you can change the color or add text or an image.



Button states

A. Pointer not over button area (Normal) **B.** Pointer enters button area (Rollover) **C.** Pointer clicks (Click)

Note: The clickable area, or hot spot, of the button is the square bounding box of the largest state in the button. For example, a round button has a square hot spot.

Change button appearances

If you’re creating a button with multiple appearances (Normal, Rollover, and Click), it’s a good idea to finish designing the button before you activate other appearances. When you activate the Rollover or Click appearance, the Normal appearance is copied.

Some changes affect only the selected appearances, while other changes affect all active appearances. If you select an appearance and apply a different background color or edit the text, the change affects only the selected appearance. If you use the Selection tool to move or resize the button, the change affects all appearances.

1. Choose Window > Interactive > Buttons to display the Buttons panel.
2. Using the Selection tool , select the button in the layout that you want to edit.
3. Click [Rollover] to activate the Rollover appearance.

The Normal appearance is copied to Rollover.

4. With Rollover still selected, change the appearance of the button.
 - To change the color, choose a swatch from the Stroke or Fill menu in the Control panel.
 - To place an image in the appearance, select the existing image by using the direct selection tool or double-clicking the existing button image, and then choose File > Place and double-click a file.
 - To paste an image into a text frame, copy it to the Clipboard, select the appearance in the Buttons panel, and then choose Edit > Paste Into.
 - To type text, select the Type tool, click the button, and type the text. You can also choose Edit > Paste Into to copy a pasted text frame.
5. To add the Click appearance, click [Click] to activate it, and then follow the same procedure to change its appearance.
6. Use the Preview panel to test the different button appearances.

 To change the size of the State Appearance thumbnails in the Buttons panel, choose Panel Options from the Buttons panel menu, select an option, and then click OK.

Delete and disable appearances

1. Select the appearance in the Buttons panel.
2. Do any of the following:
 - To delete the Rollover or Click appearance, click the Delete icon at the bottom of the panel. Deleting an appearance is especially useful if you edit the Normal appearance extensively and decide you want to base Rollover or Click on the new Normal appearance.
 - To disable an appearance without deleting it, click the Eye icon next to the appearance to deselect it. Disabled states are not exported to the PDF or SWF file.

Note: You cannot delete or disable the Normal state.

[To the top](#)

Create multi-state objects

The Object States panel lets you create multiple versions of an object. A *state* is a version of a page item. An object that includes multiple states is called a *multi-state object*.



With the Object States panel, there is no limit to the number of states you can create for an object. Each time you create a state, you generate another version of your page item. Only one state is visible on the page at a time. For print and PDF output, only the active state appears in the final output.

Create a multi-state object slide show

One of the most common uses for a multi-state object is a slide show that lets viewers of a SWF file click through a set of images. For example, you can create a slide show of 20 images without having to place the images on 20 different pages.

1. Place the images that will appear in the slide show.

For best results, make sure that the image frames are the same size.

A state does not have to be a single item—it can be a collection of items.
2. To stack the images, select them, and click Align Horizontal Centers  and Align Vertical Centers  in the Control panel.
3. With the images still selected, open the States panel (Window > Interactive > Object States), and click the Convert Selection To Multi-State Object button .



The images appear as states in the Object States panel, and a dashed frame borders the selected images.

4. Create navigation buttons that trigger the Go To Next State and Go To Previous State actions when the mouse button is release. See [Create buttons](#).
5. Use the Preview panel (Window > Interactive > Preview) to test the navigation buttons.
6. Export the document to SWF format. See [Interactive documents](#).

Edit a multi-state object

1. Select a multi-state object.

2. In the Object States panel, do any of the following:

- To edit a state, select the state in the Object States panel, and then edit the object. For example, you can add a stroke or fill or resize the object.
- To add an object to an existing state, select both the object and the multi-state object, and then click the Add Objects To Visible State button .
- To add an object to an existing multi-state object, select both the object and the multi-state object, and then click the Convert Selection To Multi-State Object button .
- To duplicate a state, select a state to base the new state on, and choose New State from the panel menu. Add, remove, or edit the content of that state.
- To paste objects into an existing state, cut or copy one or more objects, select the multi-state object, select the state in the Object States panel, and choose Paste Into State from the Object States panel menu.
- To convert a multi-state object back to a set of independent objects, select the state in the Object States panel and choose Release State To Object from the panel menu. To convert all states in the multi-state object to objects, choose Release All States To Objects.
- To delete a state and remove its contents, select the state and choose Delete State from the panel menu.
- To hide the multi-state object in the exported file until it's triggered by a button, choose Hide Until Triggered from the panel menu.
- To reset all multi-state objects in the document to the first state, choose Reset All Multi-State Objects To First State from the panel menu. When you select a state, the object remains in that state, even if you close and reopen the document. This option is a quick way to reset all the multi-state objects.

[To the top](#)

Create button hot spots

In some cases, you may want the button area (called a “hot spot” or “hot link”) to be invisible until the mouse pointer hovers over it. For example, when you move a pointer over a button on a map, an image could be displayed that represents a region, and the image could disappear when the pointer moves away from the region.

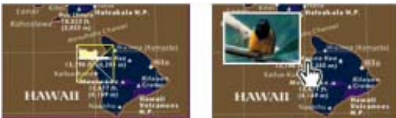

In the exported PDF file, holding the pointer over a hot spot causes an image to appear.

Display a hidden image on rollover

One way to achieve a “hot spot” effect is to apply an image to the Rollover state in the Buttons panel. To do this, create a button in which the [Rollover] state displays an image while the [Normal] state doesn't display the image.

1. Select the image you want to use as a hot spot. Make sure the frame of the image does not have a border or background.
2. In the Buttons panel (choose Window > Interactive > Buttons), click the [Normal] appearance to convert the selected image to a button.
3. Click the [Rollover] appearance in the Buttons panel to activate it.

4. Click the [Normal] appearance again. Then select the image using the Direct Selection tool  and delete the image.
Make sure you delete the image (the contents of the frame), not the frame and contents. Deleting the frame deletes the entire button.
5. Use the Preview panel to preview the hot spot effect.

Display a different button on rollover

You can create a hot spot in which clicking or mousing over an object displays another object. To do this, create two buttons, hide one of the buttons, and use the Show/Hide Button action to show and hide the target button.

1. Create an object to be used as the source button. In the Buttons panel, click the Convert Object To A Button icon.
2. Place the image you want to be used as the target button, and convert it to a button.
3. Select the target image and select Hidden Until Triggered at the bottom of the Buttons panel.

The image needs to be hidden in the exported document so that it can be displayed when the source button is moused over or clicked.

4. Select the source button and create two different actions, one to show the target image and a second to hide the target image.

If you want the image to appear when the mouse hovers over the source button, use the On Roll Over and On Roll Off events. If you want the image to appear when you click the source button and disappear when you release it, use the On Click and On Release events. In either case, use the Show/Hide Buttons action to display and hide the target button. See [Make buttons interactive](#).

5. Use the Preview panel to test the buttons.

Changing PDF options for buttons

1. Use the Selection tool  to select the button.
2. From the Buttons panel menu, choose PDF Options.
3. Type a description that acts as alternative text for visually impaired users.
4. Indicate whether the button should be printed in the PDF file, and then click OK.

[To the top](#)

Set the button tab order

The tab order determines the next (or previous) field to receive focus when a user presses Tab (or Shift+Tab) in the PDF or SWF document. The tab order includes buttons on hidden layers, but not buttons on master pages.

1. Go to the page containing the buttons.
2. Choose Object > Interactive > Set Tab Order.

3. Select each button you want to move and drag it to its new position, or click the Move Up and Move Down buttons. When you're done, click OK.

If you use Acrobat to edit the PDF and add more buttons or form fields to the page, you may need to specify a new tab order in Acrobat.

- [Hyperlinks panel overview](#)

 Twitter™ and Facebook posts are not covered under the terms of Creative Commons.

[Legal Notices](#) | [Online Privacy Policy](#)

Bookmarks

[Create bookmarks for PDF](#)
[Manage bookmarks](#)

[To the top](#)

Create bookmarks for PDF

A *bookmark* is a type of link with representative text that makes it easier to navigate documents exported as Adobe PDF. Bookmarks you create in the InDesign document appear in the Bookmarks tab on the left side of the Acrobat or Adobe Reader window. Each bookmark jumps to a text anchor or a page.

Entries in a generated table of contents are automatically added to the Bookmarks panel. In addition, you can further customize your document with bookmarks to direct a reader's attention or make navigation even easier. Bookmarks can be nested under other bookmarks.

 *You may want bookmarks to appear in the Bookmarks tab of the PDF document, but you don't want the table of contents to appear in the PDF. In this case, generate a table of contents on the last page of the document. When you export to PDF, don't include the last page. Or, if you include the last page of the exported PDF, delete it in Acrobat.*

1. Choose Window > Interactive > Bookmarks to display the Bookmarks panel.
2. Click the bookmark under which you want to place the new bookmark. If you don't select a bookmark, the new bookmark is automatically added to the end of the list.
3. Do one of the following to indicate where you want the bookmark to jump:
 - Click an insertion point in text.
 - Select text. (By default, the text you select becomes the bookmark label.)
 - Double-click a page in the Pages panel to view it in the document window.
4. Do one of the following to create the bookmark:
 - Click the Create New Bookmark icon on the Bookmarks panel.
 - Choose New Bookmark from the panel menu.

Bookmarks appear in the Bookmarks tab when you open the exported PDF file in Adobe Reader or Acrobat.

Note: *When you update the table of contents, the bookmarks are reordered, causing any bookmarks generated from a TOC to appear at the end of the list.*

[To the top](#)

Manage bookmarks

Use the Bookmarks panel to rename, delete, and arrange bookmarks.

Rename a bookmark

- Click the bookmark in the Bookmarks panel, and choose Rename Bookmark from the panel menu.

Delete a bookmark

- Click a bookmark in the Bookmarks panel, and choose Delete Bookmark from the panel menu.

Arrange, group, and sort bookmarks

You can nest a list of bookmarks to show a relationship between topics. Nesting creates a parent/child relationship. You can expand and collapse this hierarchical list as desired. Changing the order or nesting order of bookmarks does not affect the appearance of your actual document.

- Do one of the following:
 - To expand and collapse the bookmark hierarchy, click the triangle next to the bookmark icon to show or hide any children it contains.
 - To nest a bookmark under another bookmark, select the bookmark or range of bookmarks you want to nest, and then drag the icon or icons onto the parent bookmark. Release the bookmark.

The bookmark or bookmarks you dragged are nested under the parent bookmark; however, the actual page remains in its original location in the document.

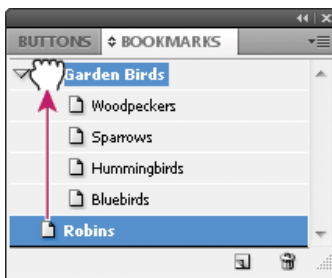

Bookmarks panel showing bookmarks being nested under a parent bookmark

- To move a bookmark out of a nested position, select the bookmark or range of bookmarks you want to move. Drag the icon or icons below and to the left of the parent bookmark. A black bar appears indicating where the bookmark will be moved. Release the bookmark.
- To change the order of bookmarks, select a bookmark and move it to a new location. A black bar appears indicating where the bookmark will be placed.
- To sort bookmarks, choose Sort Bookmarks from the Bookmarks panel menu. Bookmarks appear in the same order as the pages they jump to.

Adobe also recommends

- [Export to PDF for printing](#)

 Twitter™ and Facebook posts are not covered under the terms of Creative Commons.

[Legal Notices](#) | [Online Privacy Policy](#)

Drawing and painting

Drawing with the Pen tool

[Draw straight line segments with the Pen tool](#)

[Draw curves with the Pen tool](#)

[Reposition anchor points as you draw](#)

[Finish drawing a path](#)

[Draw straight lines followed by curves](#)

[Draw curves followed by straight lines](#)

[Draw two curved segments connected by a corner](#)

[To the top](#)

Draw straight line segments with the Pen tool

The simplest path you can draw with the Pen tool is a straight line, made by clicking the Pen tool to create two anchor points. By continuing to click, you create a path made of straight line segments connected by corner points.

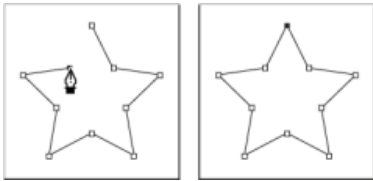

Clicking Pen tool creates straight segments.

1. Select the Pen tool.
2. Position the Pen tool where you want the straight segment to begin, and click to define the first anchor point (do not drag).

Note: The first segment you draw will not be visible until you click a second anchor point. (Select the Rubber Band option in Photoshop to preview path segments.) Also, if direction lines appear, you've accidentally dragged the Pen tool; choose *Edit > Undo*, and click again.

3. Click again where you want the segment to end (Shift-click to constrain the angle of the segment to a multiple of 45°).
4. Continue clicking to set anchor points for additional straight segments.

The last anchor point you add always appears as a solid square, indicating that it is selected. Previously defined anchor points become hollow, and deselected, as you add more anchor points.

5. Complete the path by doing one of the following:

- To close the path, position the Pen tool over the first (hollow) anchor point. A small circle appears next to the Pen tool pointer  when it is positioned correctly. Click or drag to close the path.

Note: To close a path in InDesign, you can also select the object and choose *Object > Paths > Close Path*.

- To leave the path open, Ctrl-click (Windows) or Command-click (Mac OS) anywhere away from all objects.

To leave the path open, you can also select a different tool, or choose *Select > Deselect* in Illustrator or *Edit > Deselect All* in InDesign. In InDesign or Illustrator, you can also simply press *Enter* or *Return* to leave the path open.

Draw curves with the Pen tool

You create a curve by adding an anchor point where a curve changes direction, and dragging the direction lines that shape the curve. The length and slope of the direction lines determine the shape of the curve.

Curves are easier to edit and your system can display and print them faster if you draw them using as few anchor points as possible. Using too many points can also introduce unwanted bumps in a curve. Instead, draw widely spaced anchor points, and practice shaping curves by adjusting the length and angles of the direction lines.

1. Select the Pen tool.
2. Position the Pen tool where you want the curve to begin, and hold down the mouse button.

The first anchor point appears, and the Pen tool pointer changes to an arrowhead. (In Photoshop, the pointer changes only after you've started dragging.)

3. Drag to set the slope of the curve segment you're creating, and then release the mouse button.

In general, extend the direction line about one third of the distance to the next anchor point you plan to draw. (You can adjust one or both sides of the direction line later.)

Hold down the Shift key to constrain the tool to multiples of 45°.



Drawing the first point in a curve

A. Positioning Pen tool **B.** Starting to drag (mouse button pressed) **C.** Dragging to extend direction lines

4. Position the Pen tool where you want the curve segment to end, and do one of the following:

- To create a C-shaped curve, drag in a direction opposite to the previous direction line. Then release the mouse button.

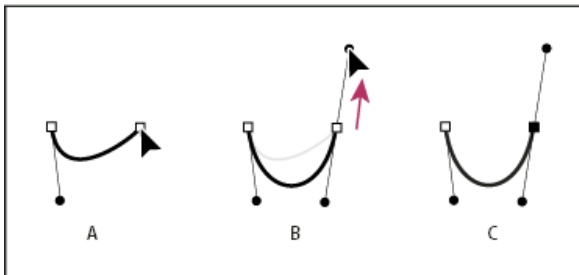

Drawing the second point in a curve

A. Starting to drag second smooth point **B.** Dragging away from previous direction line, creating a C curve **C.** Result after releasing mouse button

- To create an S-shaped curve, drag in the same direction as the previous direction line. Then release the mouse button.

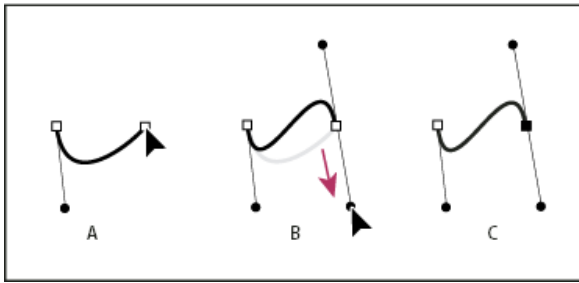

Drawing an S curve

A. Starting to drag new smooth point B. Dragging in same direction as previous direction line, creating an S curve C. Result after releasing mouse button

(Photoshop only) To change the direction of the curve sharply, release the mouse button, and then Alt-drag (Windows) or Option-drag (Mac OS) the direction point in the direction of the curve. Release the Alt (Windows) or Option (Mac OS) key and the mouse button, reposition the pointer where you want the segment to end, and drag in the opposite direction to complete the curve segment.

5. Continue dragging the Pen tool from different locations to create a series of smooth curves. Note that you are placing anchor points at the beginning and end of each curve, not at the tip of the curve.

Alt-drag (Windows) or Option-drag (Mac OS) direction lines to break out the direction lines of an anchor point.

6. Complete the path by doing one of the following:

- To close the path, position the Pen tool over the first (hollow) anchor point. A small circle appears next to the Pen tool pointer when it is positioned correctly. Click or drag to close the path.

Note: To close a path in InDesign, you can also select the object and choose Object > Paths > Close Path.

- To leave the path open, Ctrl-click (Windows) or Command-click (Mac OS) anywhere away from all objects.
To leave the path open, you can also select a different tool, or choose Select > Deselect in Illustrator or Edit > Deselect All in InDesign.

[To the top](#)

Reposition anchor points as you draw

- After you click to create an anchor point, keep the mouse button pressed down, hold down the spacebar, and drag to reposition the anchor point.

[To the top](#)

Finish drawing a path

Complete a path in one of the following ways:

1. To close a path, position the Pen tool over the first (hollow) anchor point. A small circle appears next to the Pen tool pointer when it is positioned correctly. Click or drag to close the path.

Note: To close a path in InDesign, you can also select the object and choose Object > Paths > Close Path.

2. To leave a path open, Ctrl-click (Windows) or Command-click (Mac OS) anywhere away from all objects.

To leave the path open, you can also select a different tool, or choose Select > Deselect in Illustrator or Edit > Deselect All in InDesign. In InDesign, you can also simply press Enter or Return to leave the path open.

Draw straight lines followed by curves

1. Using the Pen tool, click corner points in two locations to create a straight segment.
2. Position the Pen tool over the selected endpoint. In Illustrator and InDesign, a convert-point icon appears next to the Pen tool when it is positioned correctly (In Photoshop, a small diagonal line, or slash, appears next to the Pen tool). To set the slope of the curved segment you'll create next, click the anchor point, and drag the direction line that appears.



Drawing a straight segment followed by a curved segment (part 1)

A. Straight segment completed **B.** Positioning Pen tool over endpoint (the Convert Point icon appears only in Illustrator and InDesign) **C.** Dragging direction point

3. Position the pen where you want the next anchor point; then click (and drag, if desired) the new anchor point to complete the curve.

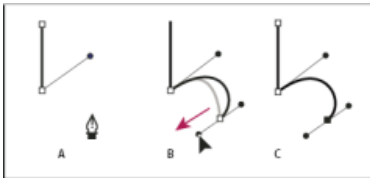

Drawing a straight segment followed by a curved segment (part 2)

A. Positioning Pen tool **B.** Dragging direction line **C.** New curve segment completed

Draw curves followed by straight lines

1. Using the Pen tool, drag to create the first smooth point of the curved segment, and release the mouse button.
2. Reposition the Pen tool where you want the curved segment to end, drag to complete the curve, and release the mouse button.

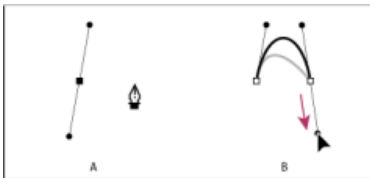

Drawing a curved segment followed by a straight segment (part 1)

A. First smooth point of curved segment completed and Pen tool positioned over endpoint **B.** Dragging to complete the curve

3. Position the Pen tool over the selected endpoint. A convert-point icon appears next to the Pen tool when it is positioned correctly. Click the anchor point to convert the smooth point to a corner point.
4. Reposition the Pen tool where you want the straight segment to end, and click to complete the straight segment.

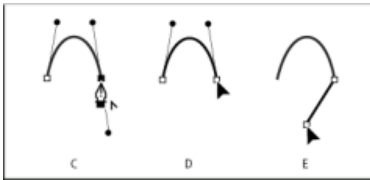

Drawing a curved segment followed by a straight segment (part 2)

A. Positioning Pen tool over existing endpoint **B.** Clicking endpoint **C.** Clicking next corner point

[To the top](#)

Draw two curved segments connected by a corner

1. Using the Pen tool, drag to create the first smooth point of a curved segment.
2. Reposition the Pen tool and drag to create a curve with a second smooth point; then press and hold Alt (Windows) or Option (Mac OS) and drag the direction line toward its opposing end to set the slope of the next curve. Release the key and the mouse button.

This process converts the smooth point to a corner point by splitting the direction lines.

3. Reposition the Pen tool where you want the second curved segment to end, and drag a new smooth point to complete the second curved segment.

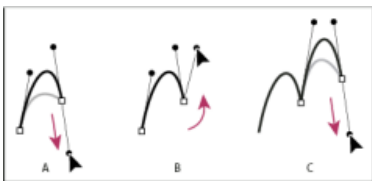

Drawing two curves

A. Dragging a new smooth point **B.** Pressing Alt/Option to split direction lines while dragging, and swinging direction line up **C.** Result after repositioning and dragging a third time

Twitter™ and Facebook posts are not covered under the terms of Creative Commons.

[Legal Notices](#) | [Online Privacy Policy](#)

Drawing with the Pencil tool

[Draw with the Pencil tool](#)
[Edit paths with the Pencil tool](#)
[Pencil tool options](#)



[To the top](#)

Draw with the Pencil tool

The Pencil tool works primarily the same way in Adobe Illustrator and InDesign. It lets you draw open and closed paths as if you were drawing with a pencil on paper. It is most useful for fast sketching or creating a hand-drawn look. Once you draw a path, you can immediately change it if needed.

Anchor points are set down as you draw with the Pencil tool; you do not determine where they are positioned. However, you can adjust them once the path is complete. The number of anchor points set down is determined by the length and complexity of the path and by tolerance settings in the Pencil Tool Preferences dialog box. These settings control how sensitive the Pencil tool is to the movement of your mouse or graphics-tablet stylus.

Draw freeform paths with the Pencil tool

1. Select the Pencil tool .
2. Position the tool where you want the path to begin, and drag to draw a path. The Pencil tool  displays a small x to indicate drawing a freeform path.

As you drag, a dotted line follows the pointer. Anchor points appear at both ends of the path and at various points along it. The path takes on the current stroke and fill attributes, and remains selected by default.

Draw closed paths with the Pencil tool

1. Select the Pencil tool.
2. Position the tool where you want the path to begin, and start dragging to draw a path.
3. After you've begun dragging, hold down Alt (Windows) or Option (Mac OS). The Pencil tool displays a small circle (and, in InDesign, a solid eraser) to indicate that you're creating a closed path.
4. When the path is the size and shape you want, release the mouse button (but not the Alt or Option key). After the path closes, release the Alt or Option key.

You don't have to position the cursor over the starting point of the path in order to create a closed path; if you release the mouse button in some other location, the Pencil tool will close the shape by creating the shortest possible line back to the original point.

[To the top](#)

Edit paths with the Pencil tool

You can edit any path using the Pencil tool and add freeform lines and shapes to any shape.

Add to a path with the Pencil tool

1. Select an existing path.
2. Select the Pencil tool.
3. Position the pencil tip on an endpoint of the path.

You can tell you're close enough to the endpoint when the small x next to the pencil tip disappears.

4. Drag to continue the path.

Connect two paths with the Pencil tool

1. Select both paths (Shift-click or drag around the two with the Selection tool).
2. Select the Pencil tool.
3. Position the pointer where you want to begin from one path, and start dragging toward the other path.
4. After you begin dragging, hold down Ctrl (Windows) or Command (Mac OS). The Pencil tool displays a small merge symbol to indicate you're adding to the existing path.
5. Drag onto the endpoint of the other path, release the mouse button, and then release the Ctrl or Command key.

Note: For best results, drag from one path to the other as if you were simply continuing the paths in the direction they were created.

Reshape paths with the Pencil tool

1. Select the path you want to change.
2. Position the Pencil tool on or near the path to redraw.

You can tell you're close enough to the path when the small x disappears from the tool.

3. Drag the tool until the path is the desired shape.



Using the Pencil tool to edit a closed shape

Note: Depending on where you begin to redraw the path and in which direction you drag, you may get unexpected results. For example,

you may unintentionally change a closed path to an open path, change an open path to a closed path, or lose a portion of a shape.

[To the top](#)

Pencil tool options

Double-click the Pencil tool to set any of the following options:

Fidelity Controls how far you have to move your mouse or stylus before a new anchor point is added to the path. The higher the value, the smoother and less complex the path. The lower the value, the more the curves will match the pointer's movement, resulting in sharper angles. Fidelity can range from 0.5 to 20 pixels.

Smoothness Controls the amount of smoothing applied when you use the tool. Smoothness can range from 0% to 100%. The higher the value, the smoother the path. The lower the value, the more anchor points are created, and the more the line's irregularities are preserved.

Fill New Pencil Strokes (Illustrator only) Applies a fill to pencil strokes you draw after selecting this option, but not to existing pencil strokes. Remember to select a fill before you draw the pencil strokes.

Keep Selected Determines whether to keep the path selected after you draw it. This option is selected by default.

Edit Selected Paths Determines whether or not you can change or merge a selected path when you are within a certain distance of it (specified with the next option).

Within: _ pixels Determines how close your mouse or stylus must be to an existing path in order to edit the path with the Pencil tool. This option is only available when the Edit Selected Paths option is selected.

 Twitter™ and Facebook posts are not covered under the terms of Creative Commons.

[Legal Notices](#) | [Online Privacy Policy](#)

Understanding paths and shapes

Types of paths and shapes

About paths

About direction lines and direction points

[To the top](#)

Types of paths and shapes

You can create paths and combine them in a variety of ways in InDesign. InDesign creates the following types of paths and shapes:

Simple paths Simple paths are the basic building blocks of compound paths and shapes. They consist of one open or closed path, which may be self-intersecting.

Compound paths Compound paths consist of two or more simple paths that interact with or intercept each other. They are more basic than compound shapes and are recognized by all PostScript-compliant applications. Paths combined in a compound path act as one object and share attributes (such as colors or stroke styles).

Compound shapes Compound shapes consist of two or more paths, compound paths, groups, blends, text outlines, text frames, or other shapes that interact with and intercept one another to create new, editable shapes. Some compound shapes appear as compound paths, but their component paths can be edited on a path-by-path basis and do not need to share attributes.

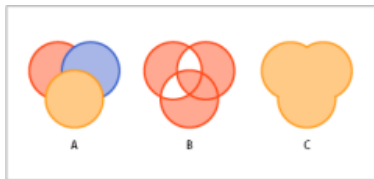

Types of paths and shapes

A. Three simple paths **B.** Compound path **C.** Compound shape

[To the top](#)

About paths

As you draw, you create a line called a *path*. A path is made up of one or more straight or curved *segments*. The beginning and end of each segment are marked by *anchor points*, which work like pins holding a wire in place. A path can be *closed* (for example, a circle), or *open*, with distinct *endpoints* (for example, a wavy line).

You change the shape of a path by dragging its anchor points, the *direction points* at the end of *direction lines* that appear at anchor points, or the path segment itself.

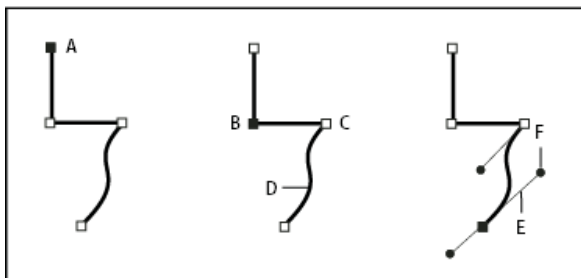

Components of a path

A. Selected (solid) endpoint **B.** Selected anchor point **C.** Unselected anchor point **D.** Curved path segment **E.** Direction line **F.** Direction point

Paths can have two kinds of anchor points: corner points and smooth points. At a *corner point*, a path abruptly changes direction. At a *smooth point*, path segments are connected as a continuous curve. You can draw a path using any combination of corner and smooth points. If you draw the wrong kind of point, you can always change it.

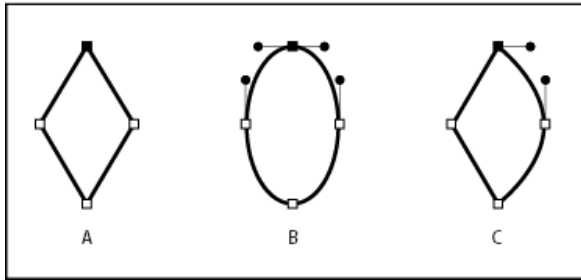

Points on a path

A. Four corner points **B.** Four smooth points **C.** Combination of corner and smooth points

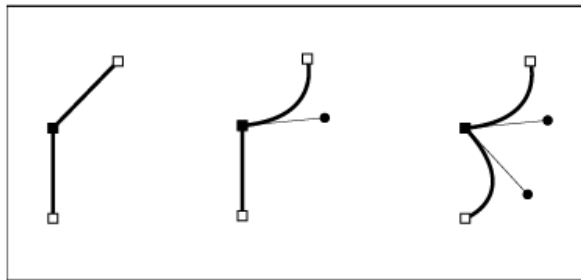

A corner point can connect both straight segments and curved segments.

Note: Don't confuse corner and smooth points with straight and curved segments.

A path's outline is called a *stroke*. A color or gradient applied to an open or closed path's interior area is called a *fill*. A stroke can have weight (thickness), color, and a dash pattern (Illustrator and InDesign) or a stylized line pattern (InDesign). After you create a path or shape, you can change the characteristics of its stroke and fill.

In InDesign, each path also displays a *center point*, which marks the center of the shape but is not part of the actual path. You can use this point to drag the path, to align the path with other elements, or to select all anchor points on the path. The center point is always visible; it can't be hidden or deleted.

[To the top](#)

About direction lines and direction points

When you select an anchor point that connects curved segments (or select the segment itself), the anchor points of the connecting segments display *direction handles*, which consist of *direction lines* that end in *direction points*. The angle and length of the direction lines determine the shape and size of the curved segments. Moving the direction points reshapes the curves. Direction lines don't appear in the final output.

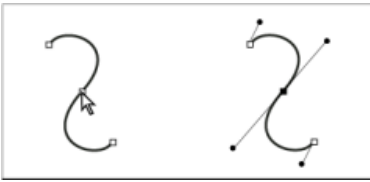

After selecting an anchor point (left), direction lines appear on any curved segments connected by the anchor point (right).

A smooth point always has two direction lines, which move together as a single, straight unit. When you move a direction line on a smooth point, the curved segments on both sides of the point are adjusted simultaneously, maintaining a continuous curve at that anchor point.

In comparison, a corner point can have two, one, or no direction lines, depending on whether it joins two, one, or no curved segments, respectively. Corner point direction lines maintain the corner by using different angles. When you move a direction line on a corner point, only the curve on the same side of the point as that direction line is adjusted.

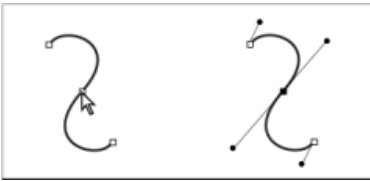

After selecting an anchor point (left), direction lines appear on any curved segments connected by the anchor point (right).

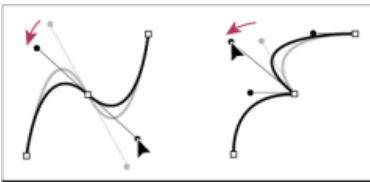

Adjusting direction lines on a smooth point (left) and a corner point (right)

Direction lines are always tangent to (perpendicular to the radius of) the curve at the anchor points. The angle of each direction line determines the slope of the curve, and the length of each direction line determines the height, or depth, of the curve.

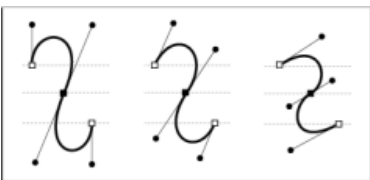

Moving and resizing direction lines changes the slope of curves.

Note: In Illustrator, you can show or hide anchor points, direction lines, and direction points by choosing *View > Show Edges* or *View > Hide Edges*.

Twitter™ and Facebook posts are not covered under the terms of Creative Commons.

[Legal Notices](#) | [Online Privacy Policy](#)

Editing paths

[Select paths, segments, and anchor points](#)

[Adjust path segments](#)

[Add or delete anchor points](#)

[Convert between smooth points and corner points](#)

[Split a path](#)

[Smooth out paths](#)

[Reshape closed paths or objects](#)

[About the Position tool](#)

[To the top](#)

Select paths, segments, and anchor points



Before you can reshape or edit a path, you need to select the path's anchor points, segments, or a combination of both.

Select anchor points

- If you can see the points, you can click them with the Direct Selection tool  to select them. Shift-click to select multiple points.
- Select the Direct Selection tool and drag a boundary around the anchor points. Shift-drag around additional anchor points to select them.
- You can select anchor points from selected or unselected paths. Move the Direct Selection tool over the anchor point until the pointer displays a hollow square for unselected and filled square for selected paths in a magnified state, and then click the anchor point. Shift-click additional anchor points to select them.
- (Illustrator only) Select the Lasso tool, and drag around the anchor points. Shift-drag around additional anchor points to select them.

Select path segments

Do any of the following:

- Select the Direct Selection tool , and click within 2 pixels of the segment, or drag a marquee over part of the segment. Shift-click or Shift-drag around additional path segments to select them.
- (Illustrator only) Select the Lasso tool , and drag around part of the path segment. Shift-drag around additional path segments to select them.

Select all anchor points and segments in a path

1. Select the Direct Selection tool  or, in Illustrator, the Lasso tool.
2. Drag around the entire path.

If the path is filled, you can also click inside the path with the Direct Selection tool to select all anchor points.

Copy a path

- Select a path or segment with the Selection tool or Direct Selection tool and do one of the following:
 - Use the standard menu functions to copy and paste paths within or between applications.
 - Press and hold Alt (Windows) or Option (Mac OS) and drag the path to the desired position, and then release the mouse button and Alt/Option key.

[To the top](#)

Adjust path segments

You can edit a path segment at any time, but editing existing segments is slightly different from drawing them. Keep the following tips in mind when editing segments:

- If an anchor point connects two segments, moving that anchor point always changes both segments.
- When drawing with the Pen tool, you can temporarily activate the Direct Selection tool (InDesign and Photoshop) so that you can adjust segments you've already drawn; press Ctrl (Windows) or Command (Mac OS) while drawing. In Illustrator, pressing Ctrl or Command while drawing activates the last-used selection tool.
- When you initially draw a smooth point with the Pen tool, dragging the direction point changes the length of the direction line on both sides of the point. However, when you edit an existing smooth point with the Direct Selection tool, you change the length of the direction line only on the side you're dragging.

Move straight segments

1. With the Direct Selection tool , select the segment you want to adjust.
2. Drag the segment to its new position.

Adjust the length or angle of straight segments

1. With the Direct Selection tool , select an anchor point on the segment you want to adjust.
2. Drag the anchor point to the desired position. Shift-drag to constrain the adjustment to multiples of 45°.

 *In Illustrator or InDesign, if you're simply trying to make a rectangle wider or narrower, it's easier to select it with the Selection tool and resize it using one of the handles on the sides of its bounding box.*

Adjust the position or shape of curved segments

1. With the Direct Selection tool, select a curved segment, or an anchor point on either end of the curved segment. Direction lines appear, if any are present. (Some curved segments use just one direction line.)
2. Do any of the following:
 - To adjust the position of the segment, drag the segment. Shift-drag to constrain the adjustment to multiples of 45°.

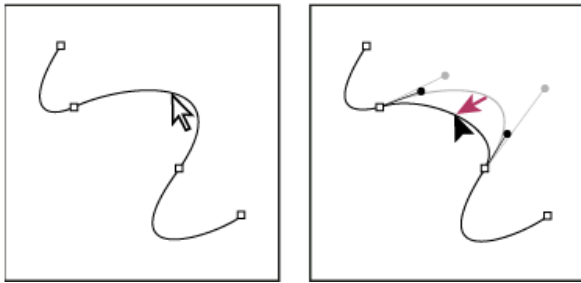

Click to select the curve segment. Then drag to adjust.

- To adjust the shape of the segment on either side of a selected anchor point, drag the anchor point or the direction point. Shift-drag to constrain movement to multiples of 45°.

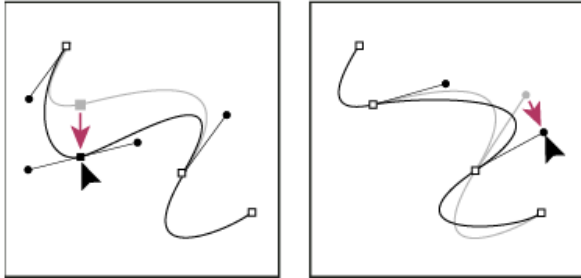

Drag the anchor point, or drag the direction point.

Note: You can also apply a transformation, such as scaling or rotating, to a segment or anchor point.

Delete a segment

1. Select the Direct Selection tool , and select the segment you want to delete.
2. Press Backspace (Windows) or Delete (Mac OS) to delete the selected segment. Pressing Backspace or Delete again erases the rest of the path.

Delete the handle of an anchor point

- Using the Convert Anchor Point Tool (Illustrator) or the Convert Direction Point Tool (InDesign), click the anchor point of the handle.
- Drag the direction point and drop it onto the anchor point.

Extend an open path

1. Using the Pen tool, position the pointer over the endpoint of the open path you want to extend. The pointer changes when it's precisely positioned over the endpoint.
2. Click the endpoint.
3. Do one of the following:
 - To create a corner point, position the Pen tool where you want to end the new segment, and click. If you are extending a path that ends at a smooth point, the new segment will be curved by the existing direction line

Note: In Illustrator, if you extend a path that ends in a smooth point, the new segment will be straight.

4. To create a smooth point, position the Pen tool where you want to end the new curved segment, and drag.

Connect two open paths

1. Using the Pen tool, position the pointer over the endpoint of the open path that you want to connect to another path. The pointer changes when it's precisely positioned over the endpoint.
2. Click the endpoint.
3. Do one of the following:
 - To connect the path to another open path, click an endpoint on the other path. When you precisely position the Pen tool over the other path's endpoint, a small merge symbol  appears next to the pointer.
 - To connect a new path to an existing path, draw the new path near the existing path, and then move the Pen tool to the existing path's (unselected) endpoint. Click that endpoint when you see the small merge symbol that appears next to the pointer.

 *In InDesign, you can also use the Pathfinder panel to join paths. To close the path of an open path, use the Selection tool to select the path and click Close Path in the Pathfinder panel. To close the end points between two paths, select the paths and click Join Path. You may want to click Join Path a second time to join the second endpoint.*

Move or nudge anchor points or segments using the keyboard

1. Select the anchor point or path segment.

Note: *In Photoshop, you can move only anchor points in this manner.*

2. Click or hold down any of the arrow keys on the keyboard to move 1 pixel at a time in the direction of the arrow.



Hold down the Shift key in addition to the arrow key to move 10 pixels at a time.

Note: *In Illustrator and InDesign, you can change the distance of a nudge by changing the Keyboard Increment preference. When you change the default increment, holding down Shift nudges 10 times the specified distance.*

[To the top](#)

Add or delete anchor points

Adding anchor points can give you more control over a path or it can extend an open path. However, it's a good idea not to add more points than necessary. A path with fewer points is easier to edit, display, and print. You can reduce the complexity of a path by deleting unnecessary points.

The toolbox contains three tools for adding or deleting points: the Pen tool , the Add Anchor Point tool , and the Delete Anchor Point tool .

By default, the Pen tool changes to the Add Anchor Point tool as you position it over a selected path, or to the Delete Anchor Point tool as you position it over an anchor point. (In Photoshop, you must select Auto Add/Delete in the options bar to enable the Pen tool to automatically change to the Add Anchor Point or Delete Anchor Point tool.)

You can select and edit multiple paths simultaneously in Photoshop and InDesign; however, you can add or delete points to only one path at a time in Illustrator. In Photoshop and InDesign, you can reshape a path while adding anchor points by clicking and dragging as you add.

Note: *Don't use the Delete, Backspace, and Clear keys or the Edit > Cut or Edit > Clear commands to delete anchor points: these keys and commands delete the point and the line segments that connect to that point.*

Add or delete anchor points

1. Select the path you want to modify.

2. Select the Pen tool, the Add Anchor Point tool, or the Delete Anchor Point tool.
3. To add an anchor point, position the pointer over a path segment and click. To delete an anchor point, position the pointer over an anchor point and click.

 In Illustrator, you can add anchor points to a path by selecting the object and choosing **Object > Path > Add Anchor Points**.

Disable or temporarily override automatic Pen tool switching



You can override automatic switching of the Pen tool to the Add Anchor Point tool or the Delete Anchor Point tool. This is useful when you want to start a new path on top of an existing path.

- In Photoshop, deselect Auto Add/Delete in the options bar.
- In Illustrator, hold down Shift as you position the Pen tool over the selected path or an anchor point. (To prevent Shift from constraining the Pen tool, release Shift before you release the mouse button.)
- In Illustrator, choose **Edit > Preferences > General (Windows)** or **Illustrator > Preferences > General (Mac OS)**, and select **Disable Auto Add/Delete**.
- In InDesign, hold down any shortcut key, make your edits, and then release the mouse button. For example, with the Pen tool selected, you can hold down the A key to display the Direct Selection tool, edit points, and the Pen tool is selected when you release the A key.

[To the top](#)

Convert between smooth points and corner points

Paths can have two kinds of anchor points—corner points and smooth points. At a *corner point*, a path abruptly changes direction. At a *smooth point*, path segments are connected as a continuous curve. The Convert Direction Point tool  lets you change an anchor point from a corner point to a smooth point or visa versa.

1. Using the Direct Selection tool , select the path you want to modify.
2. Switch to the Convert Direction Point tool . (If necessary, position the pointer over the Pen tool and drag to choose the Convert Direction Point tool.)

 To temporarily switch from the Convert Direction Point tool to the Direct Selection tool, press **Ctrl (Windows)** or **Command (Mac OS)**.

3. Position the Convert Direction Point tool over the anchor point you want to convert, and do one of the following:

To convert a corner point to a smooth point, drag direction lines out of the corner point.

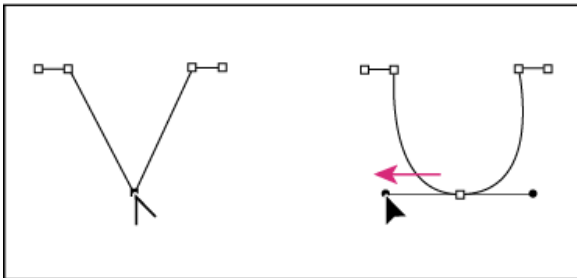

Dragging direction lines out of corner point to create smooth point

To convert a smooth point to a corner point without using direction lines, click a smooth point.

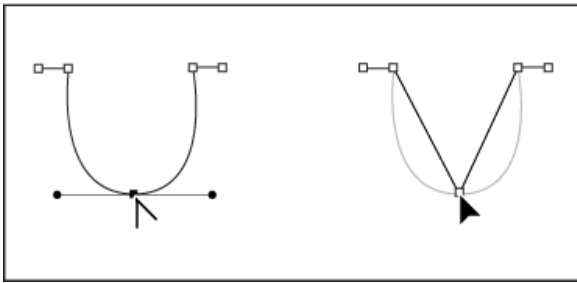

Clicking smooth point to create corner point

- To convert a corner point without using direction lines to a corner point with independent direction lines, first drag direction lines out of a corner point (making it a smooth point). Release the mouse button, and then drag either direction line.
- To convert a point, open the Pathfinder panel (choose Window > Object & Layout > Pathfinder), and click the Plain, Corner, Smooth, or Symmetrical button in the Convert Point section.
- To convert a smooth point to a corner point with independent direction lines, drag either direction line.



Converting smooth point to corner point

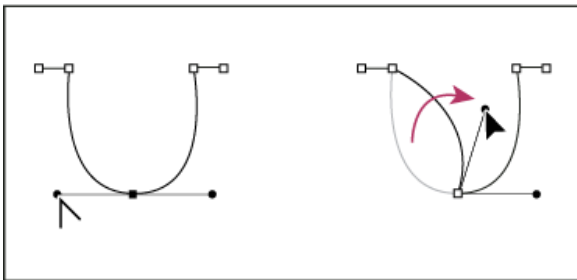

Converting smooth point to corner point

💡 To convert points, you can also use the Direct Selection tool to select a point, and then choose a command from the Object > Convert Point menu. For example, you can select the smooth point at the bottom of a “U” shape and choose Object > Convert Point > Plain. Doing so removes the direction lines and makes a “V” shape. Choose Corner to create a point with direction lines that can move independently of each other. Choose Smooth to create a point with handles that can have unequal lengths. Choose Symmetrical to create a point with handles of equal lengths.

[To the top](#)

Split a path

You can split a path, graphics frame, or empty text frame at any anchor point or along any segment. When you split a path, keep the following in mind:

- If you want to split a closed path into two open paths, you must slice in two places along the path. If you slice a closed path only once, you get a single path with a gap in it.
- Any paths resulting from a split inherit the path settings of the original path, such as stroke weight and fill color. You may need to reset stroke alignment from inside to outside.

Split a path using the Scissors tool

1. (Optional) Select the path to see its current anchor points.

2. Select the Scissors tool and click the path where you want to split it. When you split the path in the middle of a segment, the two new endpoints appear on top of the other, and one endpoint is selected.
3. Use the Direct Selection tool to adjust the new anchor point or path segment.

Open a path using the Pathfinder panel

1. Select the closed path.
2. To open the Pathfinder panel, choose Window > Object & Layout > Pathfinder.
3. Click Open Path in the Pathfinder panel.

[To the top](#)

Smooth out paths

Use the Smooth tool to remove excess angles from an existing path or a section of a path. The Smooth tool retains the original shape of the path as nearly as possible. Smoothed paths generally have fewer points, which can make them easier to edit, display, and print.

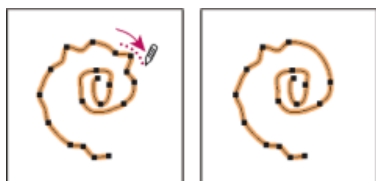

Path before and after using Smooth tool

1. Select the path.
2. Select the Smooth tool.
Note: If the Pencil tool is selected, hold down Alt (Windows) or Option (Mac OS) to temporarily change the Pencil to the Smooth tool.
3. Drag the tool along the length of the path segment you want to smooth out.
4. Continue smoothing until the stroke or path is of the desired smoothness.
5. To change the amount of smoothing, double-click the Smooth tool and set the following options:

Fidelity Controls how far your curves can stray before you have to modify the path. With lower Fidelity values, the curves will closely match the pointer's movement, resulting in sharper angles. With higher Fidelity values, the path will ignore small pointer movements, resulting in smoother curves. The pixel value range is 0.5 to 20 pixels.

Smoothness Controls the amount of smoothing applied when you use the tool. Smoothness can range from 0% to 100%; the higher the value, the smoother the path.

Keep Selected Determines whether to keep the path selected after you smooth it.

[To the top](#)

Reshape closed paths or objects

1. Using the Direct Selection tool , do one of the following:
 - Drag around the anchor points you want to select.
 - Hold down Shift as you click the anchor points you want to select.
2. Position the pointer over the anchor point or path segment that you want to act as a focal point (that is, a point that pulls the selected path segments), and click the anchor point or path segment.
3. Drag the highlighted anchor points to adjust the path. The amount of movement of a given path segment is relative to its distance from a highlighted point:
 - Selected points that act as the focal point move with the selection tool during dragging.
 - Selected points that aren't the focal point move in tandem with the dragged focal point.
 - Unselected anchor points are not affected by reshaping.

[To the top](#)

About the Position tool

The Position tool  is not available in InDesign CS5. Instead, you can use the Selection tool to select and manipulate either the frame or the content within the frame. See [Select objects](#).

Adobe also recommends

 Twitter™ and Facebook posts are not covered under the terms of Creative Commons.

[Legal Notices](#) | [Online Privacy Policy](#)

Drawing with the line or shape tools







javax.jcr.AccessDeniedException: /content/help/en/indesign/using/drawing-line-or-shape- tools/jcr:content/jcr:title: not allowed to add or modify item

- [Draw basic lines and shapes](#)
- [Draw multiple objects as a grid](#)
- [Draw a placeholder shape](#)
- [Specify polygon settings](#)
- [Change the shape of a path automatically](#)

[To the top](#)

Draw basic lines and shapes

1. In the toolbox, do one of the following:



- To draw a line or shape, select the Line tool , the Ellipse tool , the Rectangle tool , or the Polygon tool . (Click and hold the Rectangle tool to select either the Ellipse or Polygon tool.)
- To draw a placeholder (empty) graphics frame, select the Ellipse Frame tool , the Rectangle Frame tool , or the Polygon Frame tool .

2. Drag in the document window to create the path or frame.

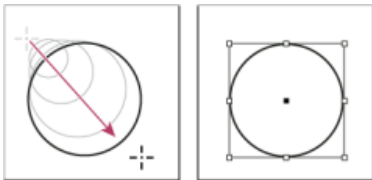
- To draw from the center out, hold down Alt (Windows) or Option (Mac OS).
- To constrain a line to 45° angles, or to constrain the width and height of a path or frame to the same proportions, hold down Shift as you drag.
- To create multiple shapes in a grid, press the arrow keys while holding down the mouse button. See [Draw multiple objects as a grid](#).
- To change the number of sides of a polygon, begin dragging, press the Spacebar, and then press the Up and Down arrow keys. Press the Left and Right arrow keys to change the star inset. Press the Spacebar again to return to grid mode.



Dragging to create a basic circle

Note: The result shown above displays a bounding box around the path. If the Selection tool  was recently active, you'll see this bounding box. If the Direct Selection tool  was more recently active, the path appears with anchor points instead.

[To the top](#)

Draw multiple objects as a grid

When using frame-creation tools such as the Rectangle tool or Type tool, you can create a grid of equally spaced frames by using modifier keys.

For a video on drawing objects in a grid, see <http://tv.adobe.com/go/4949/>.



1. Select a tool that lets you draw a frame.
2. Begin dragging. While still holding down the mouse button, do any of the following actions:
 - Press the Left and Right Arrow keys to change the number of columns. Press the Up and Down Arrow keys to change the number of rows.
 - Hold down Ctrl (Windows) or Command (Mac OS) and press arrow keys to change the spacing between the frames.
3. Release the mouse button.

If you want to use the arrow keys to change the number of sides or star inset while using the Polygon tool, press the Spacebar while holding down the mouse button.

[To the top](#)

Draw a placeholder shape

A placeholder shape is an ellipse, rectangle, or polygon that appears in the document window with an X, indicating that it should be replaced by text or an image later.

1. In the toolbox, select the Ellipse Frame tool , the Rectangle Frame tool , or the Polygon Frame tool .
2. Drag in the document window to create the path or frame. Hold down Shift to constrain the width and height of the frame.

 You can change the crop amount, reference point, and other fitting options for a placeholder frame by choosing **Object > Fitting > Frame Fitting Options**.

[To the top](#)

Specify polygon settings

1. If you want the polygon settings to apply to existing shapes, select the polygons.
2. Double-click the Polygon tool , specify the following settings, and click OK:
 - For Number of Sides, type a value for the number of sides you want for the polygon.
 - For Star Inset, type a percentage value to specify the length of a star's spikes. The tips of the spikes touch the outer edge of the polygon's bounding box, and the percentage determines the depth of the depression between each spike. Higher percentages create longer, thinner spikes.

[To the top](#)

Change the shape of a path automatically

You can convert any path into a predefined shape. For example, you can convert a rectangle to a triangle. The stroke settings for the original path remain the same for the new path. If the new path is a polygon, its shape is based on the options in the Polygon Settings dialog box. If the new path has a corner effect, its radius size is based on the size setting in the Corner Options dialog box.

1. Select the path.

2. Do any of the following:

- Choose Object > Convert Shape > *[new shape]*.
- In the Pathfinder panel (Window > Object & Layout > Pathfinder), click a shape button in the Convert Shape area.

Adobe also recommends

 Twitter™ and Facebook posts are not covered under the terms of Creative Commons.

[Legal Notices](#) | [Online Privacy Policy](#)

Compound paths and shapes

- [About compound paths](#)
- [Best practices for editing compound paths](#)
- [Create a compound path](#)
- [Change holes to fills in a compound path](#)
- [Break up a compound path](#)
- [Change the holes in a compound path](#)
- [Create compound shapes](#)
- [Create paths from text outlines](#)

[To the top](#)

About compound paths

You can combine several paths into a single object, called a *compound path*. Create a compound path when you want to do any of the following:

- Add transparent holes to a path.
- Preserve the transparent holes within some text characters, such as *o* and *e*, when you convert characters to editable letterforms using the Create Outlines command. Using the Create Outlines command always results in the creation of compound paths.
- Apply a gradient, or add contents that span multiple paths. Although you can also apply a gradient across multiple objects using the Gradient tool, applying a gradient to a compound path is often a better method because you can later edit the entire gradient by selecting any of the subpaths. With the Gradient tool, later editing requires selecting all of the paths you originally selected.

[To the top](#)

Best practices for editing compound paths

Keep the following guidelines in mind as you edit compound paths:

- Changes to path attributes (such as stroke and fill) always alter all subpaths in a composite path—it doesn't matter which selection tool you use, or how many subpaths you select. To preserve the individual stroke and fill attributes of the paths you want to combine, group them instead.
- In a compound path, any effect that is positioned relative to a path's bounding box—such as a gradient, or an image pasted inside—is actually positioned relative to the bounding box of the entire compound path (that is, the path that encloses all of the subpaths).
- If you make a compound path, then change its properties and release it, using the Release command, the released paths inherit the compound path's properties; they don't regain their original properties.
- If your document contains compound paths with many smooth points, some output devices may have problems printing them. If so, simplify or eliminate the compound paths, or convert them to bitmap images using a program such as Adobe Photoshop.
- If you apply a fill to a compound path, holes sometimes don't appear where you expect them to. For a simple path like a rectangle, the inside, or the area you can fill, is easy to see—it's the area within the enclosed path. However, with a compound path, InDesign must determine whether the intersections created by a compound path's subpaths are inside (filled areas) or outside (holes). The direction of each subpath—the order in which its points were created—determines whether the area it defines is inside or outside. If a subpath is filled when you want it to be a hole, or vice versa, click Reverse Path in the Pathfinder panel to reverse the direction of that subpath.





Create a compound path

You can create a compound path from two or more open or closed paths. When you create a compound path, all of the originally selected paths become subpaths of the new compound path. The selected paths inherit the stroke and fill settings of the object farthest back in the stacking order.

Note: If one or more selected objects have contents, such as text or imported images, the attributes and contents of a compound path are set by the attributes and contents of the object farthest back. Selected objects farther behind, without contents, won't affect the compound path.

You can change the shape of any part of a compound path by using the Direct Selection tool  to select an anchor point on one subpath.

1. Use the Selection tool  to select all of the paths you want to include in the compound path.
2. Choose Object > Paths > Make Compound Path. A hole appears wherever selected paths overlap.

 You can fill a hole created by a subpath or turn a subpath into a hole. Using the Direct Selection tool, select a point on the subpath you want to change. Then select Object > Paths > Reverse Path or click Reverse Path in the Pathfinder panel.

Change holes to fills in a compound path

The direction of each subpath—the order in which its points were created—determines whether the area it defines is inside (filled areas) or outside (empty). If, in your compound path, holes sometimes don't appear where you expect them to, you can reverse the direction of that subpath.

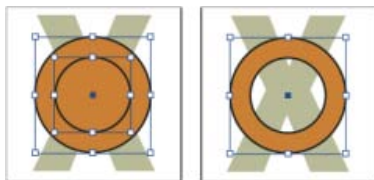

Two separate closed paths (left) and two subpaths of the same compound path (right); the compound path uses the center circle as a hole

1. With the Direct Selection tool , select the part of the compound path to reverse (or a point on that part). Do not select the entire compound path.
2. Do one of the following:
 - Choose Object > Paths > Reverse Path.
 - Click Reverse Path in the Pathfinder panel.

Break up a compound path

You can break up a compound path by releasing it, which turns each of its subpaths into an independent path.

1. Using the Selection tool , select a compound path.

2. Choose Object > Paths > Release Compound Path.

Note: The Release command is unavailable when the selected compound path is contained inside a frame, or when the path contains text.

[To the top](#)

Change the holes in a compound path

You can eliminate a hole created by a subpath or fill a subpath that has created a hole by reversing its direction.

1. Using the Direct Selection tool , select a point on the subpath you want to reverse. Don't select the entire compound path.
2. Choose Object > Paths > Reverse Path, or click Reverse Path in the Pathfinder panel.

[To the top](#)

Create compound shapes

You create compound shapes using the Pathfinder panel (Window > Object & Layout > Pathfinder). Compound shapes can be made up of simple or compound paths, text frames, text outlines, or other shapes. The appearance of the compound shape depends on which Pathfinder button you choose.

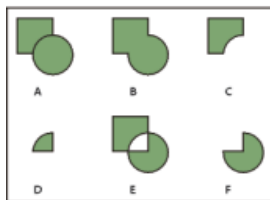
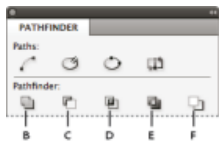

Pathfinder panel

A. Original objects **B.** Add **C.** Subtract **D.** Intersect **E.** Exclude Overlap **F.** Minus Back

Add Traces the outline of all objects to create a single shape.

Subtract Objects in the front “punch holes” in the backmost object.

Intersect Creates a shape from overlapping areas.

Exclude Overlap Creates a shape from areas that do not overlap.

Minus Back Objects in the back “punch holes” in the frontmost object.

In most cases, the resulting shape adopts the attributes (fill, stroke, transparency, layer, and so on) of the frontmost object. When you subtract shapes, however, objects in the front are deleted. The resulting shape takes on the attributes of the backmost object instead.

When you include a text frame in a compound shape, the shape of the text frame changes, but the text itself stays the same. To alter the text itself, create a compound path using text outlines.

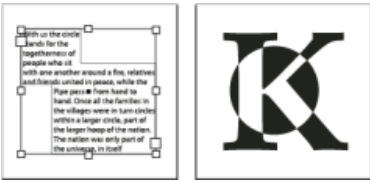

Compound shape used as a text frame (left) compared to one created from a text outline (right)

Create a compound shape

You can work with a compound shape as a single unit or release its component paths to work with each separately. For example, you might apply a gradient fill to a part of the compound shape, but leave the rest of the shape unfilled.



Gradient applied to a compound shape (left) compared to gradient applied to one part of the compound shape (right)

1. Choose Window > Object & Layout > Pathfinder to open the panel.
2. Select the objects you want to combine in a compound shape.
3. Click a button (such as Add) in the Pathfinder section on the Pathfinder panel.

You can also choose a command from the Object > Pathfinder submenu.

Release paths in a compound shape

- Select the compound shape. Choose Object > Paths > Release Compound Path. The compound shape is separated into its component paths.

 *To regroup component paths without losing changes you've applied to individual paths, choose Group in the Object menu, rather than Compound Paths > Make.*

[To the top](#)

Create paths from text outlines

Use the Create Outlines command to convert selected text characters into a set of compound paths that you can edit and manipulate as you would any other path. The Create Outlines command is useful for creating effects in large display type, but it is rarely useful for body text or other smaller-size type.

 *If you simply want to apply a color stroke, or a gradient fill or stroke to text characters, you don't need to convert the text to outlines. You can use the toolbox and the Swatches, Color, or Gradient panels to apply colors and gradients directly to the strokes or fills of selected characters.*

The Create Outlines command gets its font outline information from the actual Type 1, TrueType, or OpenType files. When you create outlines, characters are converted in their current positions, retaining all graphics formatting, such as stroke and fill.

Note: *Some font manufacturers block the information needed to create outlines. If you select such a protected font and choose Type > Create Outlines, a message will explain that the font cannot be converted.*

When you convert type to outlines, the type loses its *hints*—instructions built into outline fonts for adjusting their shapes, so that your system displays or prints them optimally at small sizes. Therefore, type converted to outlines may not display as well when rendered in small sizes or at low resolutions.

After converting type to outlines, you can do any of the following:

- Alter the letterforms by dragging individual anchor points using the Direct Selection tool .
- Copy the outlines and use the Edit > Paste Into command to mask an image by pasting it into the converted outlines.
- Use the converted outlines as text frames, so that you can type or place text in them.
- Change the stroke attributes of letterforms.
- Use text outlines to create compound shapes.

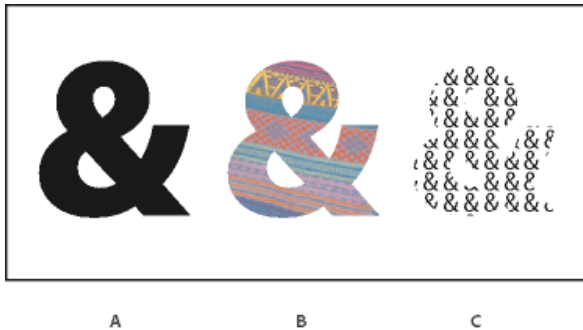

Working with text outlines

A. Type character before conversion to text outline **B.** Text outline with image pasted into it **C.** Text outline used as a text frame

Because converted text outlines become sets of compound paths, you can edit individual subpaths of converted outlines by using the Direct Selection tool. You can also break the character outlines into independent paths by releasing them from the compound path.

Convert text outlines to paths

By default, creating outlines from type removes the original text. However, if you prefer, you can make outlines appear over a copy of the original text, so that none of the text is lost.

When you select type characters in a text frame and convert them to outlines, the resulting outlines become anchored (inline) objects that flow with the text. Because the converted text is no longer true type, you will no longer be able to highlight and edit the characters using the Type tool. In addition, typographical controls will no longer apply. Make sure that you're satisfied with the typographic settings of the type you convert to outlines, and be sure to create a copy of the original text.

1. Use the Selection tool  to select a text frame, or use the Type tool to select one or more characters.
2. Choose Type > Create Outlines.

Convert a copy of text outlines to paths

1. Use the Selection tool  to select a text frame, or use the Type tool to select one or more characters.
2. Hold down Alt (Windows) or Option (Mac OS) as you choose Type > Create Outlines. The copy is created exactly on top of the original; use the Selection tool to drag it away, if you like.

Adobe also recommends



Twitter™ and Facebook posts are not covered under the terms of Creative Commons.

[Legal Notices](#) | [Online Privacy Policy](#)

Change corner appearance

Apply corner shapes using the Corner Options dialog box

Use Live Corners

Guidelines for applying corner shapes

You can use the Corner Options command to quickly apply corner effects to any path. Available corner effects range from simple, rounded corners to fancy ornamentation.

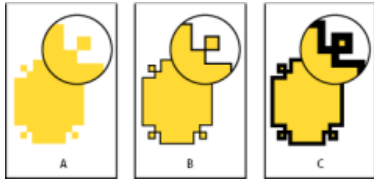

Effects of different line weights on corner shapes

A. Fancy corner effect with no stroke **B.** Same effect with 1-point stroke **C.** Same effect with 4-point stroke

For a video on using corner effects, see <http://tv.adobe.com/go/4948/>.

[To the top](#)

Apply corner shapes using the Corner Options dialog box

1. Using a selection tool, select a path.
2. Choose Object > Corner Options.
3. To apply the corner effect to all four corners of a rectangle, select the Make All Settings The Same icon . When the option is not selected, dots appear on both sides of the icon (like a broken chain link).
4. Choose a corner effect and specify a size for one or more of the corners.
The size value determines the radius by which the corner effect extends from each corner point.
5. Select Preview if you want to see the results of the effect before applying it. Then click OK.

[To the top](#)

Use Live Corners

With Live Corners, you can apply corner effects to rectangular frames by clicking the yellow box that appears on the frame and dragging. In addition, you can apply a different corner effect and a different corner radius to each corner.

1. Select a rectangular frame, and click the yellow box.
Four yellow diamonds appear on the selected frame, indicating Live Corners mode. If the yellow box does not appear on the selected frame, choose View > Extras > Show Live Corners.

2. To add corner effects, do any of the following tasks:

- To adjust the radii of all four corners together, drag one of the diamonds towards the center of the frame.
- To adjust a single corner, hold down Shift as you drag a diamond.
- To cycle through the various effects, Alt-click (Windows) or Option-click (Mac OS) a yellow diamond.

3. To stop editing corners, click anywhere outside the selected frame.

To remove corner effects, choose Object > Corner Options, and then choose None.

If you don't want the yellow box to appear when you select a frame, choose View > Extras > Hide Live Corners.

[To the top](#)

Guidelines for applying corner shapes

Note the following:

- If you've obtained plug-in software that adds more effects, the Corner Options command in the Stroke panel can include additional shapes.
- Corner effects appear on all of a path's corner points, but never on smooth points. The effects change angles automatically when you move a path's corner points.
- If a corner effect significantly changes the path by, for example, creating a bulge inward or outward, it may affect how a frame interacts with its contents or with other parts of the layout. Increasing the size of a corner effect may push an existing text wrap or frame inset farther away from the frame.
- You can't edit a corner effect, but you can change its appearance by changing the corner radius or modifying the stroke.
- If you applied corner effects but can't see them, make sure that the path uses corner points and that a stroke color or gradient has been applied to it. Then increase the Size option in the Corner Options dialog box, or increase the stroke weight in the Stroke panel.



Twitter™ and Facebook posts are not covered under the terms of Creative Commons.

[Legal Notices](#) | [Online Privacy Policy](#)

Applying line (stroke) settings

Set strokes

Stroke panel options

Add start and end shapes

Define custom stroke styles

Save custom stroke styles

[To the top](#)

Set strokes

You can apply *strokes*, or line settings, to paths, shapes, text frames, and text outlines. The Stroke panel provides control over the weight and appearance of the stroke, including how segments join, start and end shapes, and options for corners. You can also select stroke settings in the Control panel when a path or frame is selected.



 If you frequently use the same stroke settings, you can save the settings in an object style, and quickly apply the same settings to any object. For more information, see [Object styles](#).



Applying strokes

A. Stroke applied to text frame **B.** Stroke applied to text outline **C.** Stroke applied to circle

1. Select the path whose stroke you want to modify.

Note: When you select a path using the Selection tool , you activate a bounding box that encompasses the entire object. If you want to see the actual path, select the path using the Direct Selection tool  instead.

2. Choose Window > Stroke to display the Stroke panel.
3. For Weight, choose a stroke weight in the menu, or type a value and press Enter or Return.

Note: Strokes thinner than 0.25 point may be too thin to see when printed on high-resolution output devices such as an imagesetter. To remove the stroke, type a value of 0 (zero).

4. If additional options are not visible, choose Show Options from the panel menu to display the other stroke attributes.
5. Change other stroke attributes as desired.

Note: If you want to change the stroke's color, use the toolbox and Swatches panel. See [Apply color](#).

[To the top](#)

Stroke panel options

Miter Limit Specifies the limit of point length to stroke width before a mitered join becomes a beveled square join. For example, a value of 9 requires the point length to be 9 times the stroke width before the point becomes beveled. Type a value (between 1 and 500) and press Enter or

Return. The Miter Limit does not apply to a round join.

 You can include miter limit and stroke alignment settings in a paragraph or character style. Click the Character Color section, and then click the stroke icon to make the options available.

Cap Select a cap style to specify the appearance of both ends of an open path:

Butt cap 

Creates squared ends that abut (stop at) the endpoints.

Round cap 

Creates semicircular ends that extend half the stroke width beyond the endpoints.

Projecting cap 

Creates squared ends that extend half the stroke width beyond the endpoints. This option makes the stroke weight extend evenly in all directions around the path.

Note: You can specify a cap option for a closed path, but the cap will not be visible unless the path is opened (for example, by cutting with the Scissors tool). Also, cap styles are easier to see at thicker stroke weights.

Join Specify the appearance of the stroke at corner points:

Miter join 

Creates pointed corners that extend beyond the endpoint when the miter's length is within the miter limit.

Round join 

Creates rounded corners that extend half the stroke width beyond the endpoints.

Bevel join 

Creates squared corners that abut the endpoints.

Note: You can specify miter options for a path that doesn't use corner points, but the miter options will not apply until you create corner points by adding them or by converting smooth points. Also, miters are easier to see at thicker stroke weights.

Align Stroke Click an icon to specify the position of the stroke relative to its path.

Type Choose a stroke type in the menu. If you choose Dashed, a new set of options appears.

Start Choose for the beginning of the path.

End Choose for the end of the path.

Gap Color Specify a color to appear in the space between dashes, dots, or multiple lines in a patterned stroke.

Gap Tint Specify a tint (when a gap color is specified).

 Although you can define dashed strokes in the Stroke panel, it's easier to create a dashed stroke using a custom stroke style.

[To the top](#)

Add start and end shapes

Keep the following guidelines in mind as you work with start and end shapes:

You can't edit the available start and end shapes, but if you've obtained plug-in software that adds more options, the Start and End menus in the Stroke panel can include additional shapes.

- Start and end shapes are sized in proportion to the stroke weight. However, adding a start or end shape does not change the length of the path.
- Start and end shapes automatically rotate to match the angle of an endpoint's direction line.
- Start and end shapes appear at endpoints of open paths only; they won't appear on individual dashes of a dashed stroke.
- If you apply start and end shapes to a compound path that includes open subpaths, each open subpath will use the same start and end shapes.
- You can apply start and end shapes to a closed path, but they won't be visible unless you open the path.

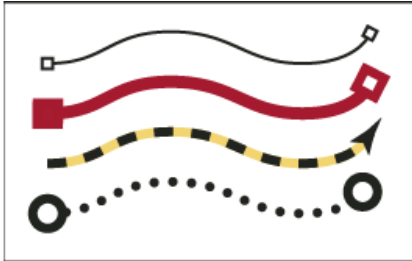

Sample start and end shapes

Create arrows using start and end shapes

Use the Start and End menus in the Stroke panel to add an arrowhead or other shape to the end of an open path.

1. Use the Line tool to draw a line, or create an open path.
2. With the line or path selected, open the Stroke panel, and choose a style in the Start and End menus. The Start menu applies a shape to the first endpoint of a path (as determined by the order in which the path's points were drawn), and the End menu applies a shape to the last endpoint.

Switch a path's start and end shapes

1. Using the Direct Selection tool , select a path.
2. Choose Object > Paths > Reverse Path, or click the Reverse Path button in the Pathfinder panel.

[To the top](#)

Define custom stroke styles

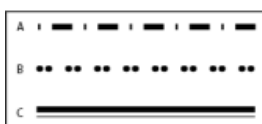

You can create a custom stroke style using the Stroke panel. A custom stroke style can be dashed, dotted, or striped; in the style, you can define the stroke's pattern, cap, and corner attributes. You specify other stroke attributes, such as weight, gap color, and start and end shapes, after the custom stroke style has been applied to an object.



Custom stroke styles

A. Dashed B. Dotted C. Striped

Custom stroke styles can be saved and loaded into other InDesign documents.

1. Choose Window > Stroke to display the Stroke panel.
2. In the panel menu, choose Stroke Styles.
3. Click New.
4. Enter a name for the stroke style.
5. For Type, select one of the following:
 - Dash to define a style with dashes spaced at regular or varying intervals.
 - Striped to define a style with one or more parallel lines.
 - Dotted to define a style with dots spaced at regular or varying intervals.The options in the dialog box change to match your selection.
6. For Pattern Length, specify the length of the repeating pattern (dashed or dotted styles only). The ruler updates to match the length you specify.
7. To define the stroke pattern, do any of the following:
 - Click the ruler to add a new dash, dot, or stripe.
 - Drag a dash, dot, or stripe to move it.
 - To adjust the width of a dash, move its ruler markers . You can also select the dash and then enter values for Start (where the dash starts on the ruler) and Length.
 - To adjust the position of a dot, move its ruler marker . You can also select the dot and then enter a value for Center (where the center of the dot is positioned).
 - To adjust the thickness of a stripe, move its ruler markers . You can also select the stripe and enter values for Start and Width, both of which are expressed as a percentage of the stroke's weight.
 - To delete a dash, dot, or stripe, drag it out of the ruler window. (However, a custom stroke style must contain at least one dash, dot, or stripe.)

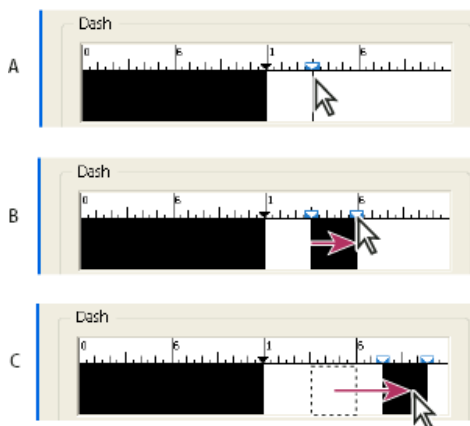

Creating a dashed line in New Stroke Style dialog box

A. Clicking to add a dash to the pattern **B.** Dragging a marker to make the dash wider **C.** Dragging the dash to adjust the white space between dashes

8. To preview the stroke at different line weights, specify a line weight using the Preview Weight option.
9. For dashed and dotted patterns, use the Corners option to determine how dashes or dots are positioned to keep a pattern regular around a corner.
10. For dashed patterns, select a style for Cap to determine the shape of the dashes. This setting overrides the Cap setting in the Stroke panel.
11. Do one of the following:
 - Click Add to save the stroke style and define another one. Click Done to exit the dialog box.
 - Click OK to save the stroke style and exit the dialog box.

[To the top](#)

Save custom stroke styles

You can save custom stroke styles for use in other InDesign documents.

Save a custom stroke style

1. In the Stroke panel menu, choose Stroke Styles.
2. Select a custom stroke style and click Save.

Note: You cannot save or edit the default stroke styles (enclosed in square brackets).

3. Specify a name and location for the stroke style (.inst) file, and click OK.

To load a custom stroke style

1. In the Stroke panel menu, choose Stroke Styles.
2. Click Load.
3. Select the stroke style (.inst) file that contains the custom stroke style you want to import, and click OK.

To apply a custom stroke style

- With a path or frame selected, choose a custom stroke style from the Type menu in the Stroke panel.

Adobe also recommends

 Twitter™ and Facebook posts are not covered under the terms of Creative Commons.

[Legal Notices](#) | [Online Privacy Policy](#)

Color

Applying color

Apply color

Select a color with the Color Picker

Apply the last used color

Remove fill or stroke color

Applying colors by dragging and dropping

Apply a color or gradient swatch

Apply color using the Color panel

Create a swatch from a color in the Color panel

Cycle through color modes

Apply colors using the Eyedropper tool

Apply colors to grayscale images



[To the top](#)

Apply color

Adobe InDesign provides a number of tools for applying color, including the Toolbox, the Swatches panel, the Color panel, the Color Picker, and the Control panel.

When you apply a color, you can specify whether the color applies to the stroke or fill of an object. The *stroke* is the border, or frame, of an object, and the *fill* is the background of an object. When you apply a color to a text frame, you can specify whether the color change affects the text frame or the text inside the frame.

1. Select the object you want to color by doing one of the following:

- For a path or frame, use the Selection tool  or the Direct Selection tool , as necessary.
- For a grayscale or monochrome (1-bit) image, click the Content Grabber or use the Direct Selection tool. You can apply only two colors to a grayscale or monochrome image.
- For text characters, use the Type tool  to change the text color of a single word or the entire text within a frame.

 *To change the color of gaps in a dashed, dotted, or striped stroke, use the Stroke panel.*

2. In the Toolbox or in the Color or Swatches panel, select the Formatting Affects Text or Formatting Affects Container to determine whether color is applied to the text or the text frame.

3. In the Toolbox or in the Color or Swatches panel, select the Fill box or the Stroke box to specify the fill or stroke of the object. (If you selected an image, the Stroke box has no effect.)

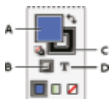

Specify how color is applied in the Toolbox

A. Fill box **B.** Formatting Affects Container **C.** Stroke box **D.** Formatting Affects Text

4. Do one of the following:

Select a color, tint, or gradient using the Swatches or Gradient panel.

- Select a color, tint, or gradient from the Fill or Stroke menu in the Control panel.
- Double-click either the Fill or Stroke box in the Toolbox or the Color panel to open the Color Picker. Select the desired color, and click OK.

 You can apply color to any grayscale image, provided it does not contain alpha or spot channels. If you imported an image with a clipping path, select the clipping path using the Direct Selection tool to apply color to the clipped area only.

[To the top](#)

Select a color with the Color Picker

The Color Picker lets you choose colors from a color field or specify colors numerically. You can define colors using the RGB, Lab, or CMYK color model.

1. Double-click either the Fill or Stroke box in the Toolbox or the Color panel to open the Color Picker.
2. To change the color spectrum displayed in the Color Picker, click a letter: R (Red), G (Green), or B (Blue); or L (luminance), a (green-red axis), or b (blue-yellow axis).

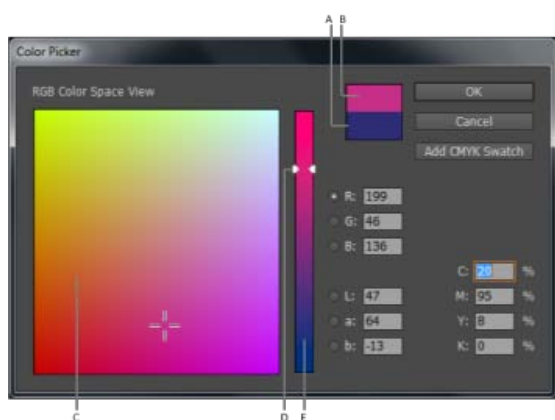

Color Picker



A. Original color **B.** New color **C.** Color field **D.** Color slider triangles **E.** Color spectrum

3. To define a color, do any of the following:
 - Click or drag inside the color field. Cross-hairs indicate the color's position in the color field.
 - Drag the color slider triangles along the color spectrum or click inside the color spectrum.
 - Enter values in any of the text boxes.
4. To save the color as a swatch, click Add CMYK Swatch, Add RGB Swatch, or Add Lab Swatch. InDesign adds the color to the Swatches panel, using the color values as its name.
5. Click OK.

[To the top](#)

Apply the last used color

The Toolbox displays the last color or gradient you applied. You can apply this color or gradient directly from the Toolbox.

1. Select the object or text you want to color.
2. In the Toolbox, click the Fill button or Stroke button depending on which portion of the text or object you want to color.
3. In the Toolbox, do one of the following:
 - Click the Color button  to apply the last selected solid color in the Swatches or Color panel.
 - Click the Gradient button  to apply the last selected gradient in the Swatches or Gradient panel.
 - Click the None button  to remove the object's fill or stroke.

[To the top](#)

Remove fill or stroke color

1. Select the text or object whose color you want to remove.
2. In the Toolbox, click the Fill button or Stroke button depending on which portion of the text or object you want to change.
3. Click the None button  to remove the object's fill or stroke.

[To the top](#)

Applying colors by dragging and dropping

An easy way to apply colors or gradients is to drag them from a color source to an object or panel. Dragging and dropping lets you apply colors or gradients to objects without first selecting the objects. You can drag the following:

- The Fill or Stroke box in the Toolbox or a panel.
- The Gradient box in the Gradient panel.
- Swatches from the Swatches panel.
- The last-used, in-gamut color swatch located next to the out-of-gamut icon  in a panel.

You can drop colors or gradients on the following objects and panels:



- The fill or stroke of a path. To drop color on a fill or stroke, position the center of the drag icon precisely over the path's fill or stroke while you drag a color, and then release the mouse button.
- The Swatches panel.

If you drag one or more Swatches panel swatches, or the color swatch next to an out-of-gamut icon, you can drop them into another InDesign document window, which adds the swatches to that document's Swatches panel.

[To the top](#)

Apply a color or gradient swatch



1. Using the Selection tool , select a text or object frame; or using the Text tool , select a range of text.
2. If the Swatches panel is not open, choose Window > Color > Swatches.
3. In the Swatches panel, select the Fill box or the Stroke box.
4. Do one of the following:
 - To apply color to selected text, click the Text button **T**.
 - To apply color to a selected object or text container (such as a frame or a table), click the Object button .
5. Click a color or gradient swatch. The selected color or gradient is applied to any selected text or object, and it appears in the Color panel and in the Fill box or Stroke box in the Toolbox.

 You can set the default fill or stroke colors the same way you set other InDesign defaults. Choose Edit > Deselect All to make sure that no objects are selected, and then choose a color.

[To the top](#)

Apply color using the Color panel

Although the Swatches panel is the recommended panel for working with colors, you can also mix colors by using the Color panel; you may be familiar with it if you use other Adobe products, such as Adobe Illustrator.

You can add the current Color panel color to the Swatches panel at any time. The Color panel is most useful for mixing unnamed colors.

Note: If you select an object that currently uses a named swatch, editing its color using the Color panel will change the color of that object only. If you want to edit the color throughout the document, double-click its swatch in the Swatches panel.

Edit the fill or stroke color

1. Select the object or text you want to change.
2. If the Color panel is not displayed, choose Window > Color.
3. Select the Fill box or the Stroke box in the Color panel.

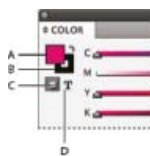

Color panel

A. Fill box **B.** Stroke box **C.** Formatting Affects Container **D.** Formatting Affects Text

4. If you selected a text frame, select the Container box  or Text box **T** to change the color of either the fill or text within the frame.
5. Do one of the following:
 - Adjust the Tint slider, which appears by default if the object uses a swatch from the Swatches panel.

- Choose a Lab, CMYK, or RGB color model in the Color panel menu, and use the sliders to change the color values. You can also enter numeric values in the text boxes next to the color sliders.
 - Position the pointer over the color bar, and click.
 - Double-click the Fill or Stroke box, and select a color from the Color Picker. Then click OK.
6. If an out-of-gamut alert icon  appears, and you want to use the CMYK color values closest to the color you originally specified, click the small color box next to the alert icon.

[To the top](#)

Create a swatch from a color in the Color panel

1. In the Color panel, make sure that the active Fill or Stroke box displays the color you want to add.
2. Choose Add To Swatches in the panel menu.

[To the top](#)

Cycle through color modes

- Do one of the following:
 - In the Color panel, Shift-click the color bar at the bottom of the panel.
 - In the New Color Swatch or Swatch Options dialog box, Shift-click the color box.
 - In the New Gradient or Gradient Options dialog box, select a gradient stop, make sure that RGB, LAB, or CMYK is selected in the Stop Color menu, and then Shift-click the color box.



[To the top](#)

Apply colors using the Eyedropper tool

Use the Eyedropper tool  to copy fill and stroke attributes, such as color, from any object in an InDesign file, including an imported graphic. By default, the Eyedropper tool loads all available fill and stroke attributes of an object and sets the default fill and stroke attributes of any new objects you draw. You can use the Eyedropper Options dialog box to change the attributes the Eyedropper tool copies. You can also use the Eyedropper tool to copy type and transparency attributes.



Note: If an attribute is not listed in the Eyedropper Options dialog box, it can't be copied with the Eyedropper tool.

Apply colors using the Eyedropper tool

1. Select one or more objects that have the fill and stroke attributes you want to change.
2. Select the Eyedropper tool .
3. Click any object that has the fill and stroke attributes you want to sample. A loaded eyedropper appears , and the selected objects are automatically updated with the fill and stroke attributes of the object you clicked.

4. To change other objects to the same attributes, click the objects with the loaded eyedropper. If an object is stroked and not filled, be sure to click the object's outline.

Pick up new attributes when the Eyedropper tool is loaded

1. Press Alt (Windows) or Option (Mac OS) while the Eyedropper tool  is loaded. The Eyedropper tool reverses direction, and appears empty , to indicate that it's ready to pick up new attributes.
2. Without releasing the Alt or Option key, click an object containing the attributes that you want to copy, and then release the Alt or Option key so that you can drop the new attributes on another object.

Change Eyedropper tool settings

1. In the Toolbox, double-click the Eyedropper tool .
2. Select the attributes in the Fill Settings and Stroke Settings sections that you want to copy with the Eyedropper tool, and then click OK.

 *To pick up only the fill or stroke color of an object and no other attributes, Shift-click the object with the Eyedropper tool. When you apply the color to another object, only the fill or stroke color is applied, depending on whether the stroke or fill is on top in the toolbar.*

[To the top](#)

Apply colors to grayscale images

You can add color to a placed grayscale image in InDesign.

1. Make sure the image is saved as a grayscale or bitmap image and that it's saved in PSD, TIFF, BMP, or JPG format.
In Photoshop, you can choose Image > Mode > Bitmap or Image > Mode > Grayscale.
2. Click the Content Grabber, or use the Direct Selection tool  to select the image.
3. Select a color from the Swatches panel or Color panel.

If the image is in PSD format, it may contain multiple layers, but the bottom layer must be opaque. You cannot apply color to a PSD image with a transparent background in InDesign. In addition, the grayscale image cannot contain alpha or spot channels.

 Twitter™ and Facebook posts are not covered under the terms of Creative Commons.

[Legal Notices](#) | [Online Privacy Policy](#)

Working with swatches

[Swatches panel overview](#)

[Create color swatches](#)

[Manage swatches](#)

[Import swatches](#)

[To the top](#)

Swatches panel overview

The Swatches panel (Window > Color > Swatches) lets you create and name colors, gradients, or tints, and quickly apply them to your document. Swatches are similar to paragraph and character styles; any change you make to a swatch affects all objects to which the swatch is applied. Swatches make it easier to modify color schemes without having to locate and adjust each individual object.

When the fill or stroke of selected text or an object contains a color or gradient applied from the Swatches panel, the applied swatch is highlighted in the Swatches panel. Swatches you create are associated only with the current document. Each document can have a different set of swatches stored in its Swatches panel.







 *When working with a prepress service provider, swatches let you clearly identify spot colors. You can also specify color settings in a preflight profile to determine which color settings work with your printer.*

Six CMYK-defined colors appear in the default Swatches panel: cyan, magenta, yellow, red, green, and blue.

Note: *When you print a book whose chapters contain conflicting swatches, you can instruct InDesign to synchronize settings with the master document. (See Synchronize book documents.)*

Swatch types

The Swatches panel stores the following types of swatches:

Colors Icons on the Swatches panel identify the spot  and process  color types, and LAB , RGB , CMYK , and Mixed Ink  color modes.

Tints A percentage value next to a swatch in the Swatches panel indicates a tint of a spot or process color.

Gradients An icon on the Swatches panel indicates whether a gradient is radial  or linear .

None The None swatch removes the stroke or fill from an object. You can't edit or remove this swatch.

Paper Paper is a built-in swatch that simulates the paper color on which you're printing. Objects behind a paper-colored object won't print where the paper-colored object overlaps them. Instead, the color of the paper on which you print shows through. You can edit the Paper color to match your paper stock by double-clicking it in the Swatches panel. Use the Paper color for previewing only—it will not be printed on a composite printer or in color separations. You can't remove this swatch. Do not apply the Paper swatch to remove color from an object. Use the None swatch instead.

Note: *If the Paper color is not working as described, and you are printing to a non-PostScript printer, try switching your printer driver to Raster Graphics mode.*

Black Black is a built-in, 100% process color black defined using the CMYK color model. You can't edit or remove this swatch. By default, all occurrences of Black overprint (print on top of) underlying inks, including text characters at any size. You can disable this behavior.

Registration Registration  is a built-in swatch that causes objects to print on every separation from a PostScript printer. For example, registration marks use the Registration color, so that printing plates can be aligned precisely on a press. You cannot edit or remove this swatch.

You can also add colors from any color library to the Swatches panel so that they are saved with your document.



Customize swatch display

You can control the size of swatches and whether the name displays with the swatch.

1. In the Swatches panel menu, choose one of the following:

- Name displays a small swatch next to the name of the swatch. The icons to the right of the name show the color model (CMYK, RGB, and so on), and whether the color is a spot color, process color, registration color, or none.
- Small Name displays compacted swatch panel rows.
- Small Swatch or Large Swatch displays only the swatch. A triangle with a dot in the corner of the swatch indicates that the color is a spot color. A triangle without a dot indicates a process color.

2. To set what type of swatches display, click one of the following buttons at the bottom of the Swatches panel:

- Show All Swatches  displays all color, tint, and gradient swatches.
- Show Color Swatches  displays only process color, spot color, mixed ink color, and tint swatches.
- Show Gradient Swatches  displays only gradient swatches.

Note: *The None swatch is always displayed regardless of which button you click.*

[To the top](#)

Create color swatches

Swatches can include spot or process colors, mixed inks (process colors mixed with one or more spot colors), RGB or Lab colors, gradients, or tints.

When you place an image that contains spot colors, the colors are automatically added as swatches to the Swatches panel. You can apply these swatches to objects in your document, but you cannot redefine or delete the swatches.

 *Before you create swatches, learn which settings are appropriate for your printer service provider. You can specify color settings in a preflight profile to highlight color settings that don't work with your printer.*

Create a new color swatch

1. Choose New Color Swatch in the Swatches panel menu.

2. For Color Type, choose the method you'll use to print document colors on a printing press.

3. For Swatch Name, do one of the following:

- If you chose Process as the color type and you want the name always to describe the color values, make sure that Name With Color Value is selected.
- If you chose Process as the color type and you want to name the color yourself, make sure that Name With Color Value is deselected, and type a Swatch Name.
- If you chose Spot, type a Swatch Name.

4. For Color Mode, choose the mode you want to use in defining the color. Avoid changing the mode after you define a color.
5. Do one of the following:
 - Drag the sliders to change the color values. You can also enter numeric values in the text boxes next to the color sliders.
 - For spot colors, choose from color libraries in the Color Mode menu.
6. If an out-of-gamut alert icon  appears, and you want to use the in-gamut color closest to the color you originally specified, click the small color box next to the alert icon.
7. Do one of the following:
 - Click Add to add the swatch and define another one. Click Done when finished.
 - Click OK to add the swatch and exit the dialog box.

 *To directly define a spot color using the New Swatch button in the Swatches panel, make sure that no swatches are selected, and then hold down Alt+Ctrl (Windows) or Option+Command (Mac OS) as you click the New Swatch button .*

Create a swatch based on the color of an object

1. Select the object.
2. In the Toolbox or Swatches panel, select the Fill box or the Stroke box.
3. In the Swatches panel, do one of the following:
 - Click the New Swatch button  and double-click the resulting new swatch.
 - Choose New Color Swatch in the Swatches panel menu.

The selected color or gradient appears in the Swatches panel and in the Fill box or Stroke box in the Toolbox, and is applied to the fill or stroke of all selected objects.

Add unnamed colors to the Swatches panel

While you can create colors using the Color panel or Color Picker, unnamed colors are more difficult to edit later and to use consistently. Use the Add Unnamed Colors option to search for unnamed colors applied to objects within the document, and then add them to the Swatches panel. Colors are automatically named according to their CMYK, RGB, or Lab components.

- In the Swatches panel, choose Add Unnamed Colors.

[To the top](#)

Manage swatches

You can edit, duplicate, and delete swatches in the Swatches panel.

Edit the default colors in the Swatches panel

You can change the swatches that appear by default in new documents.

1. Close all open documents.
2. Edit the swatches you want to change in the Swatches panel.

Duplicate a swatch

Duplicating swatches can be useful when you want to create a warmer or cooler variation of an existing color. Note that duplicating a spot color will result in an additional spot color printing plate.

- Do one of the following:
 - Select a swatch, and choose Duplicate Swatch in the Swatches panel menu.
 - Select a swatch, and click the New Swatch button  at the bottom of the panel.
 - Drag a swatch to the New Swatch button at the bottom of the panel.

Edit a swatch

You can change individual attributes of a swatch by using the Swatch Options dialog box. Additional options are available when editing mixed ink swatches and mixed ink groups.

1. In the Swatches panel, select a swatch, and do one of the following:
 - Double-click the swatch.
 - Choose Swatch Options in the Swatches panel menu.
2. Adjust settings as desired, and click OK.

Control swatch names

By default, the name of a process color swatch is derived from the values of the color's components. For example, if you create a red process color using 10% cyan, 75% magenta, 100% yellow, and 0% black, its swatch will be named C=10 M=75 Y=100 K=0 by default. This makes it easier to identify the composition of process colors.

By default, the name of a process color swatch automatically updates when you change its CMYK values; you can switch this option off or on for individual swatches as needed. As with any swatch you define, you can change the name of a process color swatch at any time.

1. Double-click a process color in the Swatches panel.
2. Do one of the following, and click OK:
 - To let InDesign rename the swatch when you adjust its CMYK percentages, make sure that the Name With Color Value option is selected.
 - To rename a swatch when you adjust its CMYK values, make sure that the Name With Color Value option is deselected.

Note: The new swatch is automatically renamed New ColorSwatch (this has a number following it if more than one New ColorSwatch exists)

when this option is deselected. You can change this name manually.

Delete individual swatches

When you delete a swatch that has been applied to an object in the document, InDesign prompts you for a replacement swatch. You can designate an existing or unnamed swatch. If you delete a swatch used as the basis of a tint or mixed ink, you will be prompted to choose a replacement.

1. Select one or more swatches.
2. Do one of the following:
 - Choose Delete Swatch in the Swatches panel menu.
 - Click the Delete icon at the bottom of the Swatches panel.

Note: You cannot delete spot colors that are used by placed graphics in the document. To delete these colors, you must first delete the graphic. However, in rare cases the spot color cannot be removed even though the graphic has been removed. In such instances, use File > Export to create an InDesign Markup (IDML) file. Then re-open that file in InDesign.

3. InDesign asks you how to replace the swatch you're deleting. Do one of the following, and click OK:
 - To replace all instances of the swatch with another swatch, click Defined Swatch, and choose a swatch in the menu.
 - To replace all instances of the swatch with an equivalent unnamed color, click Unnamed Swatch.

Delete all unused swatches

1. Choose Select All Unused in the Swatches panel menu. Only swatches that are not currently used in the active file will be selected.
2. Click the Delete icon.

Merge swatches

When you import swatches or copy items from other documents, you may end up with duplicate swatches that may be applied to different objects. Use the Merge Swatches command to combine duplicate swatches.

1. In the Swatches panel, select two or more duplicate swatches.

The first swatch you select is the one that survives (gets merged into).

2. Choose Merge Swatches in the Swatches panel menu.

Save swatches for use in other documents

To use your color swatches in other files or to share them with other designers, you can save swatches in an Adobe Swatch Exchange (.ase) file. InDesign, as well as Illustrator and Adobe Photoshop, can import swatches from a Colorbook file.

1. In the Swatches panel, select the swatches you want to save.

2. Choose Save Swatches in the Swatches panel menu.
3. Specify a name and location for the file, and click Save.

Share swatches between applications

You can share the solid swatches you create in Photoshop, Illustrator, and InDesign by saving a swatch library for exchange. The colors appear exactly the same across applications as long as your color settings are synchronized.

1. In the Swatches panel, create the process and spot color swatches you want to share, and remove any swatches you don't want to share.

Note: You cannot share the following types of swatches between applications: patterns, gradients, mixed inks and tints, and the Registration swatch from Illustrator or InDesign; and book color references, HSB, XYZ, duotone, monitorRGB, opacity, total ink, and webRGB swatches from Photoshop. These types of swatches are automatically excluded when you save swatches.

2. Select Save Swatches from the Swatches panel menu, and save the swatch libraries in an easily accessible location.
3. Load the swatch library into the Swatches panel for Photoshop, Illustrator, or InDesign.

[To the top](#)

Import swatches

You can import colors and gradients from other documents, adding either all or some of the swatches to the Swatches panel. You can load swatches from InDesign files (.indd), InDesign templates (.indt), Illustrator files (.ai or .eps), and Adobe Swatch Exchange files (.ase) created by InDesign, Illustrator, or Photoshop. Adobe Swatch Exchange files contain swatches saved in the Adobe Swatch Exchange format.

InDesign also includes color libraries from other color systems, such as the PANTONE Process Color System®.

Note: Spot colors used by imported EPS, PDF, TIFF, and Adobe Photoshop (PSD) files are also added to the Swatches panel.

Import selected swatches from a file

1. Choose New Color Swatch from the Swatches panel menu.
2. Choose Other Library from the Color Mode list, and then select the file from which you want to import swatches.
3. Click Open.
4. Select the swatches you want import.
5. Click OK.

Import all swatches from a file

1. From the Swatches panel menu, choose Load Swatches.
2. Double-click an InDesign document.

Copy swatches between InDesign documents

You can copy or drag a swatch (or objects with a swatch applied) from one document to another. When you do so, the swatch is added to the destination document's Swatches panel. If you want to copy the swatch's tints and gradients as well, you need to copy the original object, not just the swatch.

- Do one of the following:
 - Copy an object into the current document using drag-and-drop or copy-and-paste.
 - Select the swatches you want to copy and drag them from the Swatches panel to the document window of another InDesign document.

Note: *If you drag a swatch that has an identical name as an existing swatch (including capitalization) but has different color values, InDesign renames the swatch "[original swatch name] 2."*

Load swatches from predefined custom color libraries

You can select from a range of color libraries—including the PANTONE Process Color System, Toyo™ Ink Electronic Color Finder™ 1050, the Focoltone® color system, the Trumatch™ color swatch system, the DIC Process Color Note, and libraries created especially for web use. Before using swatches from a color matching system, consult with your prepress service providers to determine which ones they support.

1. Choose New Color Swatch from the Swatches panel menu.
2. Do one of the following:
 - Choose the library file from the Color Mode list.
 - Choose Other Library from the Color Mode list, locate the library file, and then click Open.
3. Select one or more swatches from the library, and click Add. (To exit the dialog box without adding swatches, click OK.)
4. When you are done adding swatches, click Done.

Color libraries installed with InDesign

InDesign installs color libraries for the color matching systems described below. You can install additional color libraries and load swatches from them in InDesign.

ANPA Color Consists of 300 colors selected by ANPA (American Newspaper Publishers Association). Colors in this library are primarily used as spot colors in newspapers.

DIC Color Provides 1280 CMYK spot colors from the DIC Process Color Note. Colors may be matched against the *DIC Color Guide*, published by Dainippon Ink & Chemicals, Inc. For more information, contact Dainippon Ink & Chemicals, Inc., in Tokyo, Japan.

Focoltone Consists of 763 CMYK colors. You can use Focoltone colors to help avoid prepress trapping and registration problems by viewing the Focoltone charts that show the overprints that make up the colors.

A swatch book with specifications for process and spot colors, overprint charts, and a chip book for marking up layouts are available from Focoltone. For more information, contact Focoltone International, Ltd., in Stafford, United Kingdom.

HKS Use when your job specifies colors from the HKS color system, which is used in Europe.

PANTONE® PANTONE® Colors are the worldwide standards for spot color reproduction. In 2000, a major revision was made to the PANTONE MATCHING SYSTEM® Color guides. 147 new solid colors and seven additional metallic colors have been added to the System to now include a total of 1,114 colors. PANTONE Color guides and chip books are now printed on coated, uncoated, and matte paper stocks to ensure accurate visualization of the printed result and better on-press control.

You can print a solid PANTONE Color in CMYK. To compare a solid PANTONE Color to its closest process color match, use the PANTONE solid to process guide. The CMYK screen tint percentages are printed under each color. The guide is now printed on a brighter coated stock and includes comparisons of the 147 new solid colors to CMYK.

PANTONE process guides let you choose from over 3,000 process combinations now printed on coated and uncoated stocks. Displayed in chromatic order in fan-guide format, it's easy to select colors and specify CMYK screen values.

For more information, contact Pantone, Inc., in Carlstadt, New Jersey, U.S.A.

System (Windows) Includes 256 colors of the Windows default 8-bit panel, which is based on a uniform sampling of RGB colors.

System (Mac OS) Includes 256 colors of the Mac OS default 8-bit panel, which is based on a uniform sampling of RGB colors.

Toyo Color Finder Includes 1050 colors based on the most common printing inks used in Japan. You can use the Toyo 94 Color Finder or the newer Toyo Color Finder. Consult the color guide that illustrates printed samples of Toyo Ink. This color guide is available at print publishers and graphic arts supply stores. For more information, contact Toyo Ink Manufacturing Co., Ltd., in Tokyo, Japan.

Trumatch Provides predictable CMYK color matching with over 2000 achievable, computer-generated colors. Trumatch colors cover the visible spectrum of the CMYK gamut in even steps. The Trumatch Color Finder displays up to 40 tints and shades of each hue, each originally created in four-color process and each reproducible in four colors on electronic imagesetters. In addition, four-color grays using different hues are included. For more information, contact Trumatch Inc., in New York, New York, U.S.A.

Web Includes the 216 RGB web-safe colors most often used by web browsers to display 8-bit images. This library helps you create artwork for the web using colors that display consistently across Windows and Macintosh systems.

Adobe also recommends

 Twitter™ and Facebook posts are not covered under the terms of Creative Commons.

[Legal Notices](#) | [Online Privacy Policy](#)

Using colors from imported graphics

[Using colors from imported graphics](#)

[Using the Eyedropper tool to sample colors](#)

[Working with spot-color channels in an Adobe Photoshop \(PSD\) file](#)

[Working with colors from EPS or PDF files](#)

[Change an imported spot color to a process color](#)

[To the top](#)

Using colors from imported graphics

InDesign provides various ways for you to sample and redefine colors from the graphics you import into your document. Spot colors from placed PDF or EPS files and spot-color channels in Adobe Photoshop (PSD) and TIFF files appear as spot colors in the Swatches panel. You can apply these colors to objects in your document or convert them to process colors; however, you cannot redefine the color values or delete the imported swatches. If you delete the placed graphic, the colors remain but are converted to native InDesign colors, which can then be edited or deleted.

[To the top](#)

Using the Eyedropper tool to sample colors

You can use the Eyedropper tool  to add colors from imported graphics to your document, or to apply them to objects in your document. This is useful for coordinating layout colors with images.

For best results with color separations, you may want to make sure that color names, types (such as spot and process), and models (such as RGB and CMYK) of the colors sampled in InDesign are consistent with the color definitions in the imported graphics. If you're not sure about the best settings to use, consult with your prepress service provider.

[To the top](#)

Working with spot-color channels in an Adobe Photoshop (PSD) file

When you place a native Photoshop file (PSD) or TIFF file in InDesign, any spot-color channels the file contains appear in the Swatches panel as spot-color inks. You can select and apply these swatches to other objects in your document; to delete these swatches, however, you must first delete the placed image.

If you import a file that has a spot-color channel with the same name as a spot color in your document, but with different color values, you will be asked whether you want to use the color values in the placed file or the ones in the document.

[To the top](#)

Working with colors from EPS or PDF files

When you place a PDF file, EPS graphic, or Adobe Illustrator (.AI) file, names of spot colors used in the graphic are added to the Swatches panel in your document, so that you can be aware that they can cause additional printing costs later, and also so that you can use the spot colors in your document.

If the graphic you are importing contains a spot color with the same name as a spot color in your document but different color values, the color values in the document are used.

[To the top](#)

Change an imported spot color to a process color

When you import an EPS, PSD, TIFF or PDF graphic containing a spot color (or a spot-color channel), InDesign adds the spot color name and

definition to the Swatches panel. You can change an imported spot color swatch to a process color swatch. This provides flexibility for adapting colors—even those in imported graphics—to your current output requirements.

1. In the Swatches panel, double-click the swatch you want to edit.
2. In the Swatch Options dialog box, choose Process in the Color Type menu.

Note: *This changes the color type in the InDesign document only. To permanently change the color type of colors within a graphic, open the graphic in the program in which it was created, and then edit the color in that program.*

Adobe also recommends

- Apply colors using the Eyedropper tool



Twitter™ and Facebook posts are not covered under the terms of Creative Commons.

[Legal Notices](#) | [Online Privacy Policy](#)

Understanding spot and process colors

javax.jcr.AccessDeniedException: /content/help/en/indesign/using/spot-process- colors/jcr:content/jcr:title: not allowed to add or modify item

[About spot and process colors](#)

[About spot colors](#)

[About process colors](#)

[Using spot and process colors together](#)

[Comparing colors in InDesign and Illustrator](#)

[To the top](#)

About spot and process colors

You can designate colors as either spot or process color types, which correspond to the two main ink types used in commercial printing. In the Swatches panel, you can identify the color type of a color using icons that appear next to the name of the color.

When applying color to paths and frames, keep in mind the final medium in which the artwork will be published, so that you apply color using the most appropriate color mode.

 *If your color workflow involves transferring documents among devices, you may want to use a color-management system (CMS) to help maintain and regulate colors throughout the process.*

[To the top](#)

About spot colors

A *spot color* is a special premixed ink that is used instead of, or in addition to, process inks, and that requires its own printing plate on a printing press. Use spot color when few colors are specified and color accuracy is critical. Spot color inks can accurately reproduce colors that are outside the gamut of process colors. However, the exact appearance of the printed spot color is determined by the combination of the ink as mixed by the commercial printer and the paper it's printed on, not by color values you specify or by color management. When you specify spot color values, you're describing the simulated appearance of the color for your monitor and composite printer only (subject to the gamut limitations of those devices).

Keep the following guidelines in mind when specifying a spot color:

- For best results in printed documents, specify a spot color from a color-matching system supported by your commercial printer. Several color-matching system libraries are included with the software.
- Minimize the number of spot colors you use. Each spot color you create will generate an additional spot color printing plate for a printing press, increasing your printing costs. If you think you might require more than four colors, consider printing your document using process colors.
- If an object contains spot colors and overlaps another object containing transparency, undesirable results may occur when exporting to EPS format, when converting spot colors to process colors using the Print dialog box, or when creating color separations in an application other than Illustrator or InDesign. For best results, use the Flattener Preview or the Separations Preview to soft proof the effects of flattening transparency before printing. In addition, you can convert the spot colors to process colors by using the Ink Manager in InDesign before printing or exporting.
- You can use a spot color printing plate to apply a varnish over areas of a process color job. In this case, your print job would use a total of five inks—four process inks and one spot varnish.

[To the top](#)

About process colors

A *process color* is printed using a combination of the four standard process inks: cyan, magenta, yellow, and black (CMYK). Use process colors when a job requires so many colors that using individual spot inks would be expensive or impractical, as when printing color photographs.

Keep the following guidelines in mind when specifying a process color:

- For best results in a high-quality printed document, specify process colors using CMYK values printed in process color reference charts, such as those available from a commercial printer.
- The final color values of a process color are its values in CMYK, so if you specify a process color using RGB (or LAB, in InDesign), those color values will be converted to CMYK when you print color separations. These conversions differ based on your color-management settings and document profile.
- Don't specify a process color based on how it looks on your monitor, unless you are sure you have set up a color-management system properly, and you understand its limitations for previewing color.
- Avoid using process colors in documents intended for online viewing only, because CMYK has a smaller color gamut than that of a typical monitor.
- Illustrator and InDesign let you specify a process color as either global or non-global. In Illustrator, global process colors remain linked to a swatch in the Swatches panel, so that if you modify the swatch of a global process color, all objects using that color are updated. Non-global process colors do not automatically update throughout the document when the color is edited. Process colors are non-global by default. In InDesign, when you apply a swatch to objects, the swatch is automatically applied as a global process color. Non-global swatches are unnamed colors, which you can edit in the Color panel.

Note: *Global and non-global process colors only affect how a particular color is applied to objects, never how colors separate or behave when you move them between applications.*

[To the top](#)

Using spot and process colors together

Sometimes it's practical to use process and spot inks in the same job. For example, you might use one spot ink to print the exact color of a company logo on the same pages of an annual report where photographs are reproduced using process color. You can also use a spot color printing plate to apply a varnish over areas of a process color job. In both cases, your print job would use a total of five inks—four process inks and one spot ink or varnish.

In InDesign, you can mix process and spot colors together to create mixed ink colors.

[To the top](#)

Comparing colors in InDesign and Illustrator

Adobe InDesign and Adobe Illustrator use slightly different methods for applying named colors. Illustrator lets you specify a named color as either global or nonglobal, and InDesign treats all unnamed colors as nonglobal, *process colors*.

The InDesign equivalents to global colors are *swatches*. Swatches make it easier to modify color schemes without having to locate and adjust each individual object. This is especially useful in standardized, production-driven documents like magazines. Because InDesign colors are linked to swatches in the Swatches panel, any change to a swatch affects all objects to which a color is applied.

The InDesign equivalents to nonglobal swatches are unnamed colors. Unnamed colors do not appear in the Swatches panel, and they do not automatically update throughout the document when the color is edited in the Color panel. You can, however, add an unnamed color to the Swatches panel later.

Named and unnamed colors only affect how a particular color updates in your document, never how colors separate or behave when you move them between applications.

Adobe also recommends

 Twitter™ and Facebook posts are not covered under the terms of Creative Commons.

[Legal Notices](#) | [Online Privacy Policy](#)

Tints

About tints Create and edit tints

[To the top](#)

About tints

A *tint* is a screened (lighter) version of a color. Tinting is an economical way to make additional spot color variations without having to pay for additional spot color inks. Tinting is also a quick way to create lighter versions of process colors, although it doesn't reduce the cost of printing process colors. As with non-tinted colors, it's best to name and store tints in the Swatches panel so that you can easily edit all instances of that tint in your document.

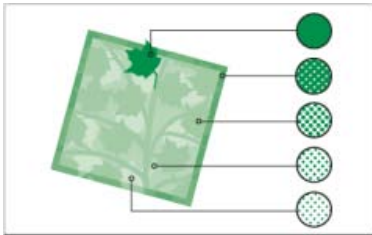

Spot color and tints

A tint of a spot color is printed on the same printing plate as the spot color. A tint of a process color multiplies each of the CMYK process inks by the tint percentage; for example, an 80% tint of C10 M20 Y40 K10 results in C8 M16 Y32 K8.

Because colors and tints update together, if you edit a swatch, all objects that use a tint of that swatch update accordingly. You can also edit the base swatch of a named tint using the Swatch Options command in the Swatches panel menu; this updates any other tints based on the same swatch.

The tint range in Adobe Creative Suite 3 is 0% to 100%; the lower the number, the lighter the tint.

[To the top](#)

Create and edit tints

You can adjust the tint of an individual object, or create tints by using the Tint slider in the Swatches panel or Color panel. The tint range is from 0% to 100%; the lower the number, the lighter the tint will be.

Because colors and tints update together, if you edit a swatch, all objects that use a tint of that swatch update accordingly. You can also edit the base swatch of a named tint using the Swatch Options command in the Swatches panel menu; this updates any other tints based on the same swatch.

Create a tint swatch using the Swatches panel

1. In the Swatches panel, select a color swatch.
2. Select the arrow next to the Tint box.
3. Drag the Tint slider, and click the New Swatch button  or select New Tint Swatch in the Swatches panel menu.

The tint appears in the Swatches panel with the name of its base color and the percentage of the tint.

Create a tint swatch using the Color panel

1. In the Swatches panel, select a swatch.
2. In the Color panel, drag the Tint slider, or enter a tint value in the Percentage box.
3. In the Color panel menu, click Add To Swatches.

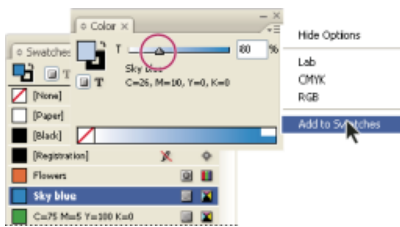

Drag the Tint slider and then click Add To Swatches.

Create an unnamed tint

1. In the Swatches panel, select the Fill box or the Stroke box.
2. Drag the Tint slider, or enter a tint value in the percentage box.

Edit a tint or base color swatch

1. In the Swatches panel, double-click the tint swatch.
2. Do one of the following, and click OK:
 - To edit the tint, change the Tint value. This updates all objects using that tint swatch.
 - To edit the tint's base color swatch, change the Color Mode or the Color Mode values. This also updates all other tints based on that same color swatch.

 Twitter™ and Facebook posts are not covered under the terms of Creative Commons.

[Legal Notices](#) | [Online Privacy Policy](#)

Mixing inks

[Create and edit mixed ink swatches](#)

[Manage mixed ink groups](#)

[To the top](#)

Create and edit mixed ink swatches

When you need to achieve the maximum number of printed colors with the fewest number of inks, you can create new ink swatches by mixing two spot inks or by mixing a spot ink with one or more process inks. Using mixed ink colors lets you increase the number of colors available without increasing the number of separations used to print the document.

You can create a single mixed ink swatch or use a mixed ink group to generate multiple swatches at once. A mixed ink group contains a series of colors created from incremental percentages of different process and spot color inks. For example, mixing four tints of process cyan (20%, 40%, 60%, and 80%) with five tints of a spot color (10%, 20%, 30%, 40%, and 50%) results in a mixed ink group that contains 20 different swatches.

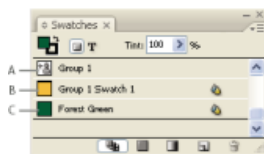

Swatches panel with mixed ink swatches

A. Parent of mixed ink group **B.** Child in mixed ink group **C.** Mixed ink swatch (standalone)

Before you can create a mixed ink swatch or a mixed ink group, you must add at least one spot color to the Swatches panel.

Create a mixed ink swatch

1. From the Swatches panel menu, choose New Mixed Ink Swatch. (This option is dimmed until you add a spot color to the Swatches panel.)
2. Type a name for the swatch.
3. To include an ink in the mixed ink swatch, click the empty box next to its name. An ink icon  appears. A mixed ink swatch must contain at least one spot color.
4. Adjust the percentage of each ink included in the swatch by using the slider bar or typing a value in the percentage box.
5. To add the mixed ink to the Swatches panel, click Add or OK.



Colors on a monitor often look different when they print. For best results, ask your commercial printer to output a sample of any mixed inks you want to print.

Create a mixed ink group

1. From the Swatches panel menu, choose New Mixed Ink Group. (This option is dimmed until you add a spot color to the Swatches panel.)
2. Type a name for the Mixed Ink Group. Colors in the group will use this name followed by an incremented Swatch suffix (Swatch 1, Swatch 2,

and so on).

3. To include an ink in the mixed ink group, click the empty box next to its name.

4. For each ink you select, do the following:

- For Initial, enter the percentage of ink you want to start mixing to create the group.
- For Repeat, specify the number of times you want to increment the ink percentage.
- For Increment, specify the percentage of ink you want to add for each repetition.

 For instance, when mixing and matching process color cyan's 4 tints (20%, 40%, 60%, 80%) and 5 spot tints (10%, 20%, 30%, 40%, 50%) to create 20 swatches, for cyan, set Initial to 20%, Repeat to 3, Increment to 20%, and set spot Initial to 10%, Repeat to 4, and Increment to 10%.

5. Click Preview Swatches to generate the swatches without closing the dialog box; you can then see whether your current ink selections and values produce the results you want, and make adjustments if they don't.

Note: An alert appears if the values you enter for Initial, Repeat, and Increment add up to more than 100% of any one ink. If you decide to proceed anyway, InDesign caps the ink percentages at 100%.

6. Click OK to add all inks in the mixed ink group to the Swatches panel.

Edit mixed ink swatches

You modify a mixed ink swatch using the same methods used to edit other swatches. As you edit a mixed ink swatch or group, be aware of the following:

- If you use the Swatches panel to delete an ink that is used in a mixed ink swatch, InDesign prompts you for a replacement. A mixed ink must contain at least one spot color, or it will be converted to a process color.
- Changes you make to the parent  of a mixed ink group apply to all mixed inks in that group. (Changes you make to a swatch in a mixed ink group apply to that swatch only.)
- Converting a mixed ink to a process or spot color removes its association with its mixed ink group.
- Deleting the parent of a mixed ink group deletes all swatches in the group.

1. In the Swatches panel, double-click the parent  of the mixed ink group you want to change.

2. Do any of the following:

- Select a new ink to replace an existing component ink.
- Click the box next to an ink to exclude or include it as a component of the mixed ink group.

Note: You cannot change the initial percentages, repeats, or increments used to create the mixed ink group.

3. Click OK.

[To the top](#)

Manage mixed ink groups

Use the Swatches panel to delete mixed ink groups, add swatches, and convert mixed ink swatches to process colors.

Delete mixed ink groups

- In the Swatches panel, select the parent of the mixed ink group you want to delete, and click the Delete button.

Add a swatch to a mixed ink group

1. In the Swatches panel, select the parent of the mixed ink group.
2. Choose New Color Swatch from the panel menu.
3. Specify a name for the swatch, if desired.
4. For each ink listed, specify the percentage you want in the mixed ink swatch. (You cannot add or delete inks.)
5. Click OK.

Convert a single mixed ink swatch to a process color

You can convert mixed inks to process colors to reduce printing costs. When you convert the parent of a mixed ink group to process, the parent swatch disappears, and the other swatches in the mixed ink group are converted to process colors.

1. Double-click the mixed ink swatch you want to convert.
2. For Color Type, select Process, and then click OK.

Convert all inks in a mixed ink group to process

- Double-click the parent  of the mixed ink group, and select Convert Mixed Ink Swatches To Process in the dialog box that appears.

Adobe also recommends

 Twitter™ and Facebook posts are not covered under the terms of Creative Commons.

[Legal Notices](#) | [Online Privacy Policy](#)

Gradients

About gradients

Create a gradient swatch

Apply an unnamed gradient using the Gradient panel

Modify gradients

Adjust a gradient with the Gradient tools

Apply a gradient across multiple objects

Applying gradients to text

[To the top](#)

About gradients

A *gradient* is a graduated blend between two or more colors or between two tints of the same color. The output device you use affects how gradients color separate.

Gradients can include Paper, process colors, spot colors, or mixed ink colors using any color mode. Gradients are defined by a series of color stops in the gradient bar. A *stop* is the point at which a gradient changes from one color to the next, and is identified by a color square under the gradient bar. By default, a gradient starts with two colors and a midpoint at 50%.

Note: *When you create a gradient using colors of different modes and then print or color separate the gradient, all colors are converted to CMYK process colors. Because of the color mode change, colors may shift. For best results, specify gradients using CMYK colors.*

[To the top](#)

Create a gradient swatch

You can create, name, and edit gradients using the same Swatches panel you use to work with solid colors and tints. You can also create unnamed gradients using the Gradient panel.

1. Choose New Gradient Swatch in the Swatches panel menu.
2. For Swatch Name, type a name for the gradient.
3. For Type, choose Linear or Radial.
4. Select the first color stop in the gradient.

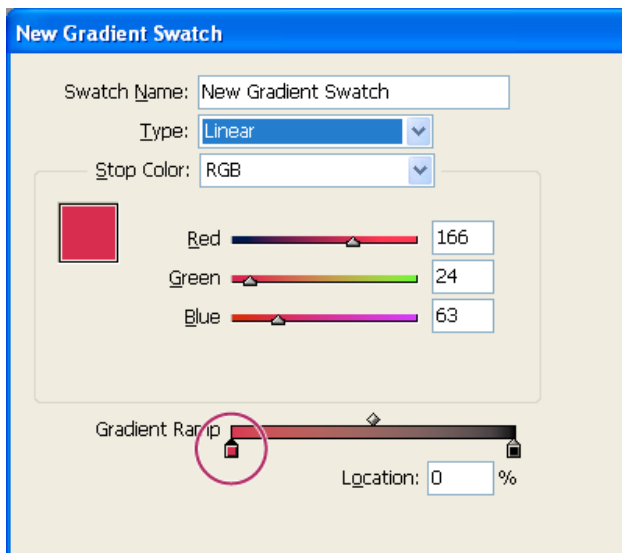

First color stop

5. For Stop Color, do one of the following:

- To choose a color that's already in the Swatches panel, choose Swatches, and select a color from the list.
- To mix a new unnamed color for the gradient, choose a color mode, and enter color values or drag the sliders.

Tip: By default, the first stop of the gradient is set to white. To make it transparent, apply the Paper swatch.

6. To change the last color in the gradient, select the last color stop, and repeat step 5.

7. To adjust the position of gradient colors, do one of the following:

- Drag the color stops located under the bar.
- Select a color stop under the bar, and enter a Location value to set the position of that color. This position represents the percentage of distance between the previous color and the next color.

8. To adjust the midpoint between two gradient colors (the point at which the colors are at 50%), do one of the following:

- Drag the diamond icon located above the bar.
- Select the diamond icon above the bar, and enter a Location value to set the position of that color. This position represents the percentage of distance between the previous color and the next color.

9. Click OK or Add. The gradient is stored in the Swatches panel with its name.

[To the top](#)

Apply an unnamed gradient using the Gradient panel

Although the Swatches panel is the recommended panel for creating and storing gradients, you can also work with gradients by using the Gradient panel (Window > Color > Gradient), with which you may be familiar if you also use Adobe Illustrator. You can add the current gradient to the Swatches panel at any time. The Gradient panel is useful for creating an unnamed gradient that won't be used often.

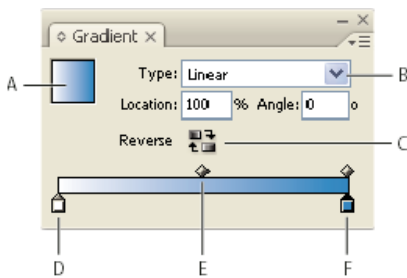

Gradient panel

A. Gradient fill **B.** Gradient type menu **C.** Reverse button **D.** Starting color stop **E.** Midpoint **F.** Ending color stop

Note: If you select an object that currently uses a named gradient, editing the gradient by using the Gradient panel will change the color of that object only. To edit every instance of a named gradient, double-click its swatch in the Swatches panel.

1. Select the object or objects you want to change.
2. Click the Fill or Stroke box in the Swatches panel or the Toolbox. (If the Gradient Fill box is not visible, choose Show Options in the Gradient panel menu.)
3. To open the Gradient panel, choose Window > Color > Gradient, or double-click the Gradient tool  in the Toolbox.
4. To define the starting color of a gradient, click the leftmost color stop below the gradient bar, and then do one of the following:
 - Drag a swatch from the Swatches panel and drop it on the color stop.
 - Alt-click (Windows) or Option-click (Mac OS) a color swatch in the Swatches panel.
 - In the Color panel, create a color using the sliders or the color bar.
5. To define the ending color of the gradient, click the rightmost color stop below the gradient bar. Then choose the color you like, as described in the previous step.
6. Select either Linear or Radial in the Type menu, and adjust color and midpoint positions as explained in [Create a gradient swatch](#).
7. To adjust the gradient angle, type a value for Angle.

[To the top](#)

Modify gradients

You can modify gradients by adding colors to create multicolor gradients, and by adjusting color stops and midpoints. It's a good idea to fill an object with the gradient you plan to adjust, so that you can preview the effect on the object while you adjust the gradient.

 You can modify gradients pasted from Adobe Illustrator, provided that the gradient was pasted using AICB (Adobe Illustrator Clipboard) format. (See [Pasting Illustrator graphics into InDesign](#).) To select the gradient, use the Direct Selection tool.

Note: If you edit a color swatch, any gradient stops that use that swatch will update accordingly, changing the gradient.

Add intermediate colors to a gradient

1. Double-click a gradient swatch in the Swatches panel, or display the Gradient panel.
2. Click anywhere below the gradient bar to define a new color stop. The new color stop is automatically defined by the color values at that position along the existing gradient.

3. Adjust the new color stop.

 You can also drag a swatch from the Swatches panel onto the gradient bar in the Gradient panel to define a new color stop.

Remove an intermediate color from a gradient



- Select the intermediate color stop, and drag it to the edge of the panel.

Reverse a gradient's color progression

1. Activate a gradient.
2. In the Gradient panel, click the Reverse button .

[To the top](#)

Adjust a gradient with the Gradient tools

Once you have filled an object with a gradient, you can modify the gradient by using the Gradient Swatch tool  or the Gradient Feather tool  to “repaint” the fill by dragging along an imaginary line. The Gradient tools let you change the direction of a gradient, change its beginning point and endpoint, and apply a gradient across multiple objects. The Gradient Feather tool lets you soften the gradient in the direction in which you drag.

1. In the Swatches panel or Toolbox, select the Fill box or the Stroke box, depending on where the original gradient was applied.
2. Select the Gradient Swatch or Gradient Feather tool, and position it at the place where you want to define the beginning point of the gradient. Drag across the object in the direction you want the gradient to be applied. Hold down Shift to constrain the tool to multiples of 45°.

Dragging the Gradient Feather tool across the gradient progressively softens the colors in the gradient within the area you drag.

3. Release the mouse button at the place where you want to define the endpoint of the gradient.

[To the top](#)

Apply a gradient across multiple objects

1. Make sure that all selected objects already use a gradient.
2. In the Toolbox, select the Fill box or the Stroke box.
3. Select the Gradient tool , and position it where you want to define the beginning point of the gradient. Drag across the object in the direction you want the gradient to be applied. Hold down Shift to constrain the tool to multiples of 45°.
4. Release the mouse button at the place where you want to define the endpoint of the gradient.

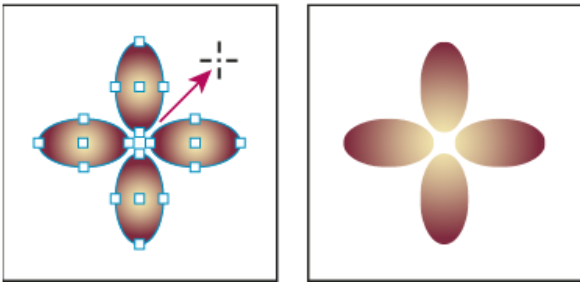

Default gradient fill (left) and gradient applied across objects (right)

💡 If a compound path with a gradient is selected, you can edit the gradient across all of its subpaths by using the Gradient panel alone, without having to use the Gradient tool.

[To the top](#)

Applying gradients to text

Within a single text frame, you can create multiple ranges of gradient text alongside default black text and color text.

A gradient's endpoints are always anchored in relation to the bounding box of the gradient's path or text frame. Individual text characters display the part of the gradient over which they are positioned. If you resize the text frame or make other changes that cause text characters to reflow, the characters are redistributed across the gradient, and the colors of individual characters change accordingly.

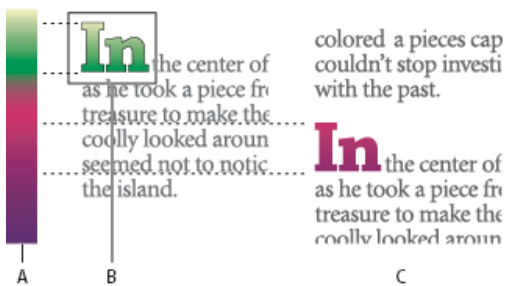

Working with gradient-filled text characters

A. Underlying gradient fill **B.** Text characters with gradient applied **C.** Text added, and text shifting position relative to gradient fill

If you want to adjust a gradient so that its complete color range spans a specific range of text characters, you have two options:

- Use the Gradient tool to reset the gradient's endpoints, so that they span only the characters you selected when you applied the gradient.
- Select the text and convert it to outlines (editable paths), and then apply a gradient to the resulting outlines. This is the best option for a short run of display type in its own text frame. The gradient will be permanently anchored to the outlines, not the text frame, and the outlines will continue to flow with the rest of the text. However, the outlines will function as a single inline graphic within the text frame, so you won't be able to edit the text. Also, typographic options will no longer apply; for example, text converted to outlines will not hyphenate.

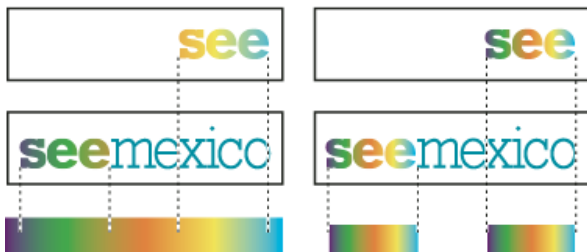

By default, type that shifts position will change relative to its gradient (left); when type is converted to outlines, an applied gradient moves with the type (right).

For information on converting text outlines to paths, see [Create paths from text outlines](#).

Multiple gradients in a single text frame

Within a single text frame, you can select different ranges of text and apply a unique gradient to each range. Each gradient is added to the text frame and tracked separately with the characters you selected when you applied each gradient. However, the endpoints of the gradient are still anchored to the text frame's bounding box, not to individual ranges of text.

Adobe also recommends



Twitter™ and Facebook posts are not covered under the terms of Creative Commons.

[Legal Notices](#) | [Online Privacy Policy](#)

Understanding color management

[Why colors sometimes don't match](#)

[What is a color management system?](#)

[Do you need color management?](#)

[Creating a viewing environment for color management](#)

A color management system reconciles color differences among devices so that you can confidently predict the colors your system ultimately produces. Viewing color accurately allows you to make sound color decisions throughout your workflow, from digital capture through final output. Color management also allows you to create output based on ISO, SWOP, and Japan Color print production standards.

[To the top](#)

Why colors sometimes don't match

No device in a publishing system is capable of reproducing the full range of colors viewable to the human eye. Each device operates within a specific color space that can produce a certain range, or gamut, of colors.

A color model determines the relationship between values, and the color space defines the absolute meaning of those values as colors. Some color models (such as CIE L*a*b) have a fixed color space because they relate directly to the way humans perceive color. These models are described as being device-independent. Other color models (RGB, HSL, HSB, CMYK, and so forth) can have many different color spaces. Because these models vary with each associated color space or device, they are described as being device-dependent.

Because of these varying color spaces, colors can shift in appearance as you transfer documents between different devices. Color variations can result from differences in image sources; the way software applications define color; print media (newsprint paper reproduces a smaller gamut than magazine-quality paper); and other natural variations, such as manufacturing differences in monitors or monitor age.

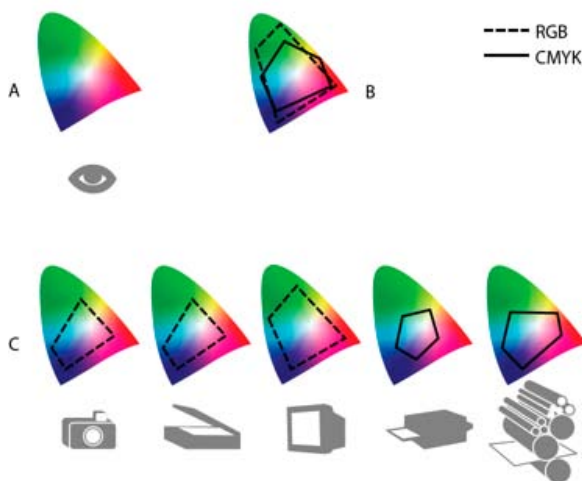

Color gamuts of various devices and documents

A. Lab color space B. Documents (working space) C. Devices

[To the top](#)

What is a color management system?

Color-matching problems result from various devices and software using different color spaces. One solution is to have a system that interprets and translates color accurately between devices. A color management system (CMS) compares the color space in which a color was created to the color space in which the same color will be output, and makes the necessary adjustments to represent the color as consistently as possible among different devices.

A color management system translates colors with the help of color profiles. A profile is a mathematical description of a device's color space. For example, a scanner profile tells a color management system how your scanner "sees" colors. Adobe color management uses ICC profiles, a format defined by the International Color Consortium (ICC) as a cross-platform standard.

Because no single color-translation method is ideal for all types of graphics, a color management system provides a choice of rendering intents, or translation methods, so that you can apply a method appropriate to a particular graphics element. For example, a color translation method that preserves correct relationships among colors in a wildlife photograph may alter the colors in a logo containing flat tints of color.

Note: Don't confuse color management with color correction. A color management system won't correct an image that was saved with tonal or color balance problems. It provides an environment where you can evaluate images reliably in the context of your final output.

Do you need color management?

Without a color management system, your color specifications are device-dependent. You might not need color management if your production process is tightly controlled for one medium only. For example, you or your print service provider can tailor CMYK images and specify color values for a known, specific set of printing conditions.

The value of color management increases when you have more variables in your production process. Color management is recommended if you anticipate reusing color graphics for print and online media, using various kinds of devices within a single medium (such as different printing presses), or if you manage multiple workstations.

You will benefit from a color management system if you need to accomplish any of the following:

- Get predictable and consistent color output on multiple output devices including color separations, your desktop printer, and your monitor. Color management is especially useful for adjusting color for devices with a relatively limited gamut, such as a four-color process printing press.
- Accurately soft-proof (preview) a color document on your monitor by making it simulate a specific output device. (Soft-proofing is subject to the limitations of monitor display, and other factors such as room lighting conditions.)
- Accurately evaluate and consistently incorporate color graphics from many different sources if they also use color management, and even in some cases if they don't.
- Send color documents to different output devices and media without having to manually adjust colors in documents or original graphics. This is valuable when creating images that will eventually be used both in print and online.
- Print color correctly to an unknown color output device; for example, you could store a document online for consistently reproducible on-demand color printing anywhere in the world.

Creating a viewing environment for color management

Your work environment influences how you see color on your monitor and on printed output. For best results, control the colors and light in your work environment by doing the following:

- View your documents in an environment that provides a consistent light level and color temperature. For example, the color characteristics of sunlight change throughout the day and alter the way colors appear on your screen, so keep shades closed or work in a windowless room. To eliminate the blue-green cast from fluorescent lighting, you can install D50 (5000° Kelvin) lighting. You can also view printed documents using a D50 lightbox.
- View your document in a room with neutral-colored walls and ceiling. A room's color can affect the perception of both monitor color and printed color. The best color for a viewing room is neutral gray. Also, the color of your clothing reflecting off the glass of your monitor may affect the appearance of colors on-screen.
- Remove colorful background patterns on your monitor desktop. Busy or bright patterns surrounding a document interfere with accurate color perception. Set your desktop to display neutral grays only.
- View document proofs in the real-world conditions under which your audience will see the final piece. For example, you might want to see how a housewares catalog looks under the incandescent light bulbs used in homes, or view an office furniture catalog under the fluorescent lighting used in offices. However, always make final color judgements under the lighting conditions specified by the legal requirements for contract proofs in your country.

More Help topics



|

Transparency

Adding transparency effects

- [About transparency](#)
- [Effects panel overview](#)
- [Apply transparency effects](#)
- [Transparency effects](#)
- [Use Global Light](#)
- [Set the opacity of an object](#)
- [Applying transparency to groups](#)
- [Change the appearance of transparent artwork on screen](#)
- [Stop displaying transparency](#)
- [Removing white box effect in documents with transparency](#)

When you create an object in Adobe InDesign, by default it appears solid; that is, it has an opacity of 100%. You can apply effects to objects using opacity and blends. Overlap objects, add transparency to objects, or knock out shapes behind objects.

[To the top](#)

About transparency

When you create an object or stroke, when you apply a fill, or when you enter text, by default these items appear solid; that is, they have an opacity of 100%. You can make the items transparent in a variety of ways. For example, you can vary the opacity from 100% (completely opaque) to 0% (completely transparent). When you decrease opacity, the underlying artwork becomes visible through the surface of the object, stroke, fill, or text.

You use the Effects panel to specify the opacity an object, its stroke, its fill, or its text. You can decide how the object itself, its stroke, fill, or text blend with objects beneath. Where objects are concerned, you can choose to isolate blending to specific objects so that only some objects in a group blend with objects below them, or you can have objects knock out rather than blend with objects in a group.



Areas of underlying objects appear through transparent object.

[To the top](#)

Effects panel overview

Use the Effects panel (Window > Effects) to specify the opacity and blending mode of objects and groups, isolate blending to a particular group, knock out objects inside a group, or apply a transparency effect.

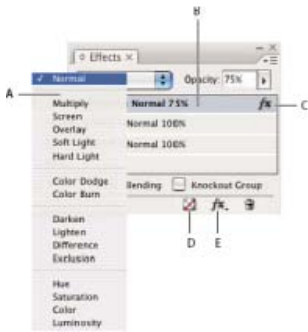

Add and edit transparency effects in the Effects panel
A. Blending mode **B.** Levels **C.** FX icon **D.** Clear effects **E.** FX button

Blending Mode

Specifies how colors in transparent objects interact with the objects behind them. (See [Specify how colors blend.](#))

Opacity

Determines the opacity of an object, stroke, fill, or text. (See [Set the opacity of an object.](#))

Level

Tells you the Object, Stroke, Fill, and Text opacity settings of the object, as well as whether transparency effects have been applied. Click the triangle to the left of the word Object (or Group or Graphic) to hide or display these level settings. The FX icon appears on a level after you apply transparency settings there, and you can double-click the FX icon to edit the settings.

Isolate Blending

Applies a blending mode to a selected group of objects. (See [Isolate blending modes.](#))

Knockout Group

Makes the opacity and blending attributes of every object in a group knock out, or block out, underlying objects in the group. (See [Knock out objects within a group.](#))

Clear All button

Clears effects—stroke, fill, or text— from an object, sets the blend mode to Normal, and changes the Opacity setting to 100% throughout the object.

FX button

Displays a list of transparency effects. (See [Apply transparency effects.](#))

Display Effects panel options

- Choose Window > Effects and, if necessary, open the Effects panel menu and choose Show Options.

The Effects panel options are also available in the Effects dialog box (select an object and choose Object > Effects > Transparency) and, in simplified form, on the Control panel.

[To the top](#)

Apply transparency effects

1. Select an object. To apply effects to a graphic, select the graphic with the Direct Selection tool.
2. Choose Window > Effects to display the Effects panel.
3. Select a level to designate which parts or part of the object you want to change:

Object Affects the entire object—its stroke, fill, and text.

Graphic Affects only the graphic selected with the Direct Selection tool. Effects you apply to the graphic remain with it when you paste the graphic in a different frame.

Group Affects all objects and text in the group. (Use the Direct Selection tool to apply effects to objects within a group.)

Stroke Affects only the object's stroke (including its gap color).

Fill Affects only the object's fill.

Text Affects only text inside the object, not the text frame. Effects you apply to text affect all the text in the object; you can't apply an effect to individual words or letters.

You can also choose a level setting in the Control panel: Click the Apply Effect To Object button , and select Object, Stroke, Fill, or Text.

4. Do any of the following to open the Effects dialog box:

- In the Effects panel or Control panel, click the FX button  and choose an effect from the menu.
- From the Effects panel menu, choose Effects and then an effect name.
- From the context menu, choose Effects and then an effect name.
- Choose Object > Effects, and then choose an effect name.
- On the Effects panel, click the triangle to display level settings if necessary, and then double-click a level setting—Object, Stroke, Fill, or Text—on the Effects panel. By double-clicking, you both open the Effects dialog box and choose a level setting.

5. Choose options and settings for the effect. (See [Common transparency settings and options](#).)

6. Click OK.

Edit a transparency effect

1. Select the object or objects to which the effect has been applied.

2. Do one of the following to open the Effects dialog box.

- On the Effects panel, double-click the FX icon to the right of Object (not at the bottom of the panel). You may need to click the triangle next to the word *Object* to display the FX icon.
- Select the level with the effect you want to edit, click the FX button  in the Effects panel, and choose the name of an effect.

3. Edit the effect.

Copy transparency effects

• Do any of the following to copy transparency effects:



- To copy effects between objects, select the object with the effect you want to copy, select the object's FX icon  in the Effects panel,

and drag the FX icon to the other object. You can drag and drop effects between objects only to and from the same level.

- To copy effects between objects selectively, use the Eyedropper tool . To control which transparency stroke, fill, and object settings are copied with the Eyedropper tool, double-click the tool to open the Eyedropper Options dialog box. Then select or deselect options in the Stroke Settings, Fill Settings, and Object Settings areas.
- To copy effects from one level to another in the same object, Alt-drag (Windows) or Option-drag (Mac OS) the FX icon from one level to another (Stroke, Fill, or Text) on the Effects panel.

 You can move effects from one level to another in the same object by dragging the FX icon.

Clear transparency effects from an object

- Do any of the following:
 - To clear all effects from an object as well as change the blending mode to Normal and the Opacity setting to 100%, click the Clear All Effects button  in the Effects panel or choose Clear All Transparency on the Effect panel menu.
 - To clear all effects but maintain the blending and opacity settings, select a level and choose Clear Effects on the Effects panel menu or drag the FX icon  from the Stroke, Fill, or Text level in the Effects panel to the Trash icon.
 - To clear multiple levels (Stroke, Fill, or Text) of an effect, select the levels and click the Trash icon.
 - To remove an individual effect from an object, open the Effects dialog box and deselect a Transparency effect.

[To the top](#)

Transparency effects

InDesign offers nine transparency effects. Many of the settings and options for creating these effects are similar.

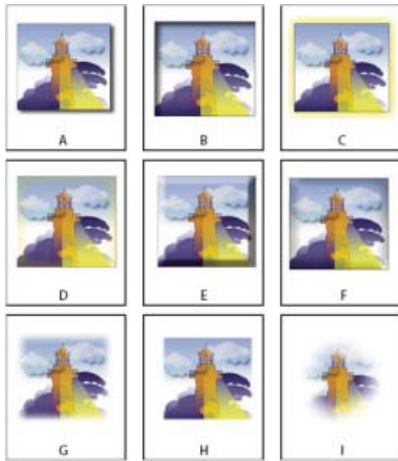

Effects

A. Drop Shadow **B. Inner Shadow** **C. Outer Glow** **D. Inner Glow** **E. Bevel and Emboss** **F. Satin** **G. Basic Feather** **H. Directional Feather** **I. Gradient Feather**

Drop Shadow Adds a shadow that falls behind the object, stroke, fill, or text.

Inner Shadow Adds a shadow that falls just inside the edges of the object, stroke, fill, or text, giving it a recessed appearance.

Outer Glow and Inner Glow Add glows that emanate from the outside or inside edges of the object, stroke, fill, or text.

Bevel and Emboss Adds various combinations of highlights and shadows to give text and images a three-dimensional appearance.

Satin Adds interior shading that makes a satiny finish.

Basic Feather, Directional Feather, and Gradient Feather Soften the edges of an object by fading them to transparent.

Note: In addition to the descriptions covered here, see [Common transparency settings and options](#).

Common transparency settings and options

Many transparency effect settings and options are the same across different effects. Common transparency settings and options include the following:

Angle and Altitude Determine the lighting angle at which a lighting effect is applied. A setting of 0 is equivalent to ground level; 90 is directly above the object. Click the angle radius or enter a degree measurement. Select Use Global Light if you want a uniform lighting angle for all objects. Used by the Drop Shadow, Inner Shadow, Bevel and Emboss, Satin, and Feather effects.

Blending Mode Specifies how colors in transparent objects interact with the objects behind them. Used by the Drop Shadow, Inner Shadow, Outer Glow, Inner Glow, and Satin effects. (See Specify how colors blend.)

Choke Along with the Size setting, determines how much of the shadow or glow is opaque and how much is transparent; large settings increase opacity and small settings increase transparency. Used by the Inner Shadow, Inner Glow, and Feather effects.

Distance Specifies the offset distance for the Drop Shadow, Inner Shadow, or Satin effect.

Noise Specifies the amount of random elements in the opacity of a glow or shadow as you enter a value or drag the slider. Used by the Drop Shadow, Inner Shadow, Outer Glow, Inner Glow, and Feather effects.

Opacity Determines the opacity of an effect; drag the slider or enter a percentage measurement. (See [Set the opacity of an object](#).) Used by the Drop Shadow, Inner Shadow, Outer Glow, Inner Glow, Gradient Feather, Bevel and Emboss, and Satin effects.

Size Specifies the amount of shadow or glow. Used by the Drop Shadow, Inner Shadow, Outer Glow, Inner Glow, and Satin effects.

Spread Determines the transparency of the blur within the shadow or glow effect as established by the Size setting. A higher percentage makes the blur more opaque. Used by the Drop Shadow and Outer Glow.

Technique These settings determine how the edge of a transparency effect interacts with background colors. Softer and Precise are available for the Outer Glow and Inner Glow effects:

Softer Applies a blur to the edge of the effect. At larger sizes, doesn't preserve detailed features.

Precise Preserves the edge of the effect, including its corners and other sharp details. Preserves features better than the Softer technique.

Use Global Light Applies the global light setting to the shadow. Used by the Drop Shadow, Bevel and Emboss, and Inner Shadow effects.

X Offset and Y Offset Offsets the shadow on the x- or y-axis by the amount you specify. Used by the Drop Shadow and Inner Shadow effects.

Drop Shadow

The Drop Shadow effect creates a three-dimensional shadow. You can offset the drop shadow along the x or y axis, as well as vary the blending mode, color, opacity, distance, angle, and size of the drop shadow. Use these options to determine how the drop shadow interacts with objects and transparency effects:

Object Knocks Out Shadow The object appears in front of the drop shadow that it casts.

Shadow Honors Other Effects The drop shadow factors in other transparency effects. For example, if the object is feathered on one side, you can make the drop-shadow disregard the feathering such that the shadow doesn't fade out, or make the shadow look feathered in the same way as the object is feathered.

Click the Drop Shadow button  on the Control panel to quickly apply a drop shadow to or remove a drop shadow from an object, a stroke, a fill, or text.

 *To select a color for a drop shadow, click the Set Shadow Color button (next to the Blending Mode menu) and choose a color.*

Inner Shadow

The Inner Shadow effect places the shadow inside the object, giving the impression that the object is recessed. You can offset the inner shadow along different axes and vary the blending mode, opacity, distance, angle, size, noise, and choke of the shadow.

Outer Glow

The Outer Glow effect makes the glow emanate from under the object. You can set the blending mode, opacity, technique, noise, size, and spread.

Inner Glow

The Inner Glow effect causes an object to glow from the inside out. Choose the blending mode, opacity, technique, size, noise and choke settings, as well as the Source setting:

Source Specifies the source for the glow. Choose Center to apply a glow that emanates from the center; choose Edge to apply a glow that emanates from the object's boundaries.

Bevel and Emboss

Use the Bevel and Emboss effect to give objects a realistic, three-dimensional look. The Structure settings determine the object's size and shape:

Style Specifies the bevel style: Outer Bevel creates the bevel on the outside edges of the object; Inner Bevel creates the bevel on the inside edges; Emboss simulates the effect of embossing the object against underlying objects; Pillow Emboss simulates the effect of stamping the edges of the object into underlying objects.

Size Determines the size of the bevel or emboss effect.

Technique Determines how the edge of the bevel or emboss effect interacts with background colors: Smooth blurs the edges slightly (and doesn't preserve detailed features at larger sizes); Chisel Soft blurs the edges, but not as much as the Smooth technique (it preserves detailed features better than the Smooth technique but not as well as the Chisel Hard technique); Chisel Hard provides a harder, more conspicuous edge (it preserves detailed features better than the Smooth or Chisel Soft techniques).

Soften In addition to the Technique setting, blurs the effect to reduce unwanted artifacts and rough edges.

Direction Choose Up or Down to make the effect appear pushed up or down.

Depth Specifies the depth of the bevel or emboss effect.

The Shading settings determine how light interacts with the object:

Angle and Altitude Sets the height of the light source. A setting of 0 is equivalent to ground level; 90 is directly above the object.

Use Global Light Applies the global light source as specified for all transparency effects. Choosing this option overrides any Angle and Altitude settings.

Highlight and Shadow Specifies the blending mode for the bevel or emboss highlight and shadow.

Satin

Use the Satin effect to give objects a smooth, satin-like finish. Choose the blending mode, opacity, angle, distance, and size settings, as well as whether to invert colors and transparencies:

Invert Select this option to reverse the colored and transparent areas of the object.

Basic Feather

The Feather effect softens (fades) the edges of an object over a distance that you specify:

Feather Width

Sets the distance over which the object fades from opaque to transparent.

Choke

Along with the Feather Width setting, determines how much of the softening glow is opaque and how much is transparent; a large setting increases opacity and a small setting increases transparency.

Corners

Choose Sharp, Rounded, or Diffused:

Sharp Follows the outer edge of the shape, including sharp corners. This option is appropriate for star-like objects and a special effect on a rectangular shape.

Rounded Rounds the corner by the feather radius; essentially, the shape is first inset, then outset, to form the two contours. This option works well with rectangles.

Diffused Uses the Adobe Illustrator method, which makes the edges of the object fade from opaque to transparent.

Noise

Specifies the amount of random elements in the softening glow. Use this option to soften the glow.

Directional Feather

The Directional Feather effect softens the edges of an object by fading the edges to transparent from directions that you specify. For example, you can apply feathering to the top and bottom of the object, not the left or right side.

Feather Widths

Set the distance over which the top, bottom, left side, and right side of the object fade to transparent. Select the Lock option to fade each side of the object by the same distance.

Noise

Specifies the amount of random elements in the softening glow. Use this option to create a softer glow.

Choke

Along with the Width settings, determines how much of the glow is opaque and how much is transparent; large settings increase opacity and small

settings increase transparency.

Shape

Choose an option—First Edge Only, Leading Edges, or All Edges—to demarcate the object's original shape.

Angle

Rotates the frame of reference for the feathering effect such that, as long as you don't enter a multiple of 90 degrees, the feathering edges are skewed rather than parallel to the object.

Gradient Feather

Use the Gradient Feather effect to soften the areas of an object by fading them to transparent.

Gradient Stops

Create one gradient stop for each gradation in transparency that you want for your object.

- To create a gradient stop, click below the Gradient Slider (drag a gradient stop away from the slider to remove a stop).
- To adjust the position of a stop, drag it left or right, or select it and then drag the Location slider.
- To adjust the mid-point between two opacity stops, drag a diamond above the Gradient Slider. Where the diamond is located determines how abrupt or gradual the transition between stops is.

Reverse Gradient

Click to reverse the direction of the gradations. This box is located to the right of the Gradient Slider.

Opacity

Specifies the transparency between gradient points. Select a point and drag the Opacity slider.

Location

Adjusts the position of a gradient stop. Select a gradient stop before dragging the slider or entering a measurement.

Type

Linear shades from the starting gradient point to the ending gradient point in a straight line; Radial shades from the starting point to the ending point in a circular pattern.

Angle

For linear gradients, establishes the angle of the gradation lines. At 90 degrees, for example, the lines run horizontally; at 180 degrees, the lines run vertically.

[To the top](#)

Use Global Light

You can apply a uniform lighting angle to transparency effects in which shading is a factor: Drop Shadow, Inner Shadow, and Bevel and Emboss. When you choose Use Global Light with these effects, lighting is determined by the global setting in the Global Light dialog box.

1. Do any of the following to open the Global Light dialog box:

- Choose Global Light from the Effects panel menu.
- Choose Object > Effects > Global Light.

2. Enter a value or drag the angle radius to set the Angle and Altitude, and click OK.

[To the top](#)

Set the opacity of an object

You can apply transparency to a single object or selected objects (including graphics and text frames), but not to individual text characters or

layers. However, imported graphics with those types of transparency effects will appear and print correctly.

1. Select the object or objects.

The word *mixed* appears in the Effects panel if you select multiple objects and their opacity settings conflict. For example, if the Fill opacity setting is different in objects you selected, the Transparency palette reads, “Fill: Opacity (mixed).”

2. Choose Object, Stroke, Fill, or Text with any of these techniques:

- Click the Apply Effects button  on the Control panel and choose an option.
- Click an option on the Effects panel (click the triangle next to the word Object, if necessary, to see the options).

3. On the Control panel or Effects panel, type a value for Opacity or click the arrow next to the Opacity setting and drag the slider. As the opacity value of objects is reduced, the transparency increases.

Note: If you direct-select and cut or copy an object from a transparent group in InDesign, and then paste the object somewhere else in the document, the pasted object won't be transparent unless it was previously selected individually and had transparency applied.

[To the top](#)

Applying transparency to groups

Besides applying transparency effects to single objects, you can apply them to groups.

If you simply select objects and change their individual opacity settings, the selected objects' opacity will change relative to that of the others. Any overlapping areas will show an accumulated opacity.

In contrast, if you target a group that has been created with the Group command, and then change the opacity, the group is treated as a single object by the Effects panel (the Effects panel shows only one level option—Group), and the opacities within the group don't change. In other words, objects within the group don't interact with each other in transparency.

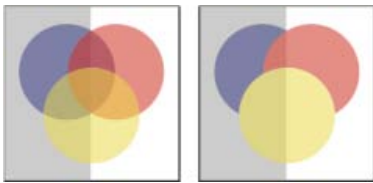

Individual objects selected and set to 50% opacity (left) and group selected and set to 50% opacity (right)

[To the top](#)

Change the appearance of transparent artwork on screen

Use the Display Performance dialog box to set transparency preferences. These preferences determine the on-screen quality of transparent objects in new documents and in documents saved with modified preferences. You can also set the preferences to turn on or off the display of transparency in the document. Turning off transparency in the display preferences doesn't turn off transparency when printing or exporting the file.

Note: Before you print a file containing transparency effects, make sure that you check the transparency preferences first. Printing automatically flattens the artwork, and may affect the appearance of the transparency effects.

1. Choose Edit > Preferences > Display Performance (Windows) or Adobe InDesign > Preferences > Display Performance (Mac OS).
2. Select an option (Fast, Typical, High Quality) in the Adjust View Settings section to determine the on-screen resolution of any effect in the document. The settings you change apply only to the option you select here:

- Fast turns off transparency and sets the resolution to 24 dpi.
- Typical displays low-resolution effects and sets the resolution to 72 dpi.
- High Quality improves the display of effects, especially in PDF and EPS files, and sets the resolution to 144 dpi.

3. Drag the Transparency slider. The default setting is Medium Quality, which displays drop shadows and feathering.

4. Click OK.

5. When inks overlap with blend modes, choose **View > Overprint Preview**. This option ensures that you can see on screen how any inks interact with transparency.

 Use the **View** menu to quickly change transparency display between *Fast Display*, *Typical Display*, and *High Quality Display*.

[To the top](#)

Stop displaying transparency

To improve display performance, you can turn off the display of transparency. Turning off transparency on screen doesn't turn off transparency for printing or exporting the file.

- Choose **View > Display Performance > Fast Display**.

[To the top](#)

Removing white box effect in documents with transparency

In some instances, a white box or ghost border appears where a transparency effect is applied, usually in documents that contain drop shadows or gradients. This problem may occur if the transparency effect interacts with a spot color.

To fix this problem, you can either avoid using spot colors with transparency or you can turn on overprinting.

To view and print a PDF document without the white box effect, in Acrobat enable Simulate Overprinting. In Acrobat 9, choose **Advanced > Print Production > Output Preview**. In Acrobat X, choose **Tools > Print Production > Output Preview**.

If you're sending the document to a printer that's experiencing this white box effect, ask the service provider to turn on PostScript Overprint at the RIP. If this doesn't work, you can flatten the transparency and select the Simulate Overprint option before you send the file. In InDesign, this option is found on the Output panel of the Print dialog box when you select the Composite CMYK option.

Adobe also recommends



Twitter™ and Facebook posts are not covered under the terms of Creative Commons.

[Legal Notices](#) | [Online Privacy Policy](#)

Flattening transparent artwork

About flattening

[About transparency flattener presets](#)

[Apply a flattener preset for output](#)

[Create or edit a transparency flattener preset](#)

[Export and import a custom transparency flattener preset](#)

[Rename or delete a custom transparency flattener preset](#)

[Flatten an individual spread](#)

[Ignore the flattener preset on an individual spread](#)

[Transparency Flattener options](#)

[Preview which areas of artwork will be flattened](#)

[Refresh the preview in the Flattener Preview panel](#)

[Best practices when creating transparency](#)

[To the top](#)

About flattening

If your document or artwork contains transparency, to be output it usually needs to undergo a process called *flattening*. Flattening divides transparent artwork into vector-based areas and rasterized areas. As artwork becomes more complex (mixing images, vectors, type, spot colors, overprinting, and so on), so does the flattening and its results.

Flattening may be necessary when you print or when you save or export to other formats that don't support transparency. To retain transparency without flattening when you create PDF files, save your file as Adobe PDF 1.4 (Acrobat 5.0) or later.

You can specify flattening settings and then save and apply them as transparency flattener presets. Transparent objects are flattened according to the settings in the selected flattener preset.

Note: *Transparency flattening cannot be undone after the file is saved.*



Overlapping art is divided when flattened.

 For more information on transparency output issues, see the [Print Service Provider Resources page of the Adobe Solutions Network \(ASN\)](#) (English only), available on the [Adobe website](#).

[To the top](#)

About transparency flattener presets

If you regularly print or export documents that contain transparency, you can automate the flattening process by saving flattening settings in a *transparency flattener preset*. You can then apply these settings for print output as well as for saving and exporting files to PDF 1.3 (Acrobat 4.0) and EPS and PostScript formats. In addition, in Illustrator you can apply them when saving files to earlier versions of Illustrator or when copying to the clipboard; in Acrobat, you can also apply them when optimizing PDFs.

These settings also control how flattening occurs when you export to formats that don't support transparency.

You can choose a flattener preset in the Advanced panel of the Print dialog box or of the format-specific dialog box that appears after the initial Export or Save As dialog box. You can create your own flattener presets or choose from the default options provided with the software. The settings of each of these defaults are designed to match the quality and speed of the flattening with an appropriate resolution for rasterized transparent areas, depending on the document's intended use:

High Resolution is for final press output and for high-quality proofs, such as separations-based color proofs.

Medium Resolution is for desktop proofs and print-on-demand documents that will be printed on PostScript color printers.

Low Resolution is for quick proofs that will be printed on black-and-white desktop printers and for documents that will be published on the web or exported to SVG.

[To the top](#)

Apply a flattener preset for output

You can choose a flattener preset in the Print dialog box, or in the format-specific dialog box that appears after the initial Export dialog box.

If you regularly export or print documents that contain transparency, you can automate the flattening process by saving flattener settings in a *transparency flattener preset*. You can then apply these settings when you print or export to PDF 1.3 (Acrobat 4.0) or EPS formats.

- In the Advanced panel of the Print, Export EPS, or Export Adobe PDF dialog box, choose a custom preset or one of the following default presets:

Low Resolution Use for quick proofs that will be printed on black-and-white desktop printers, and for documents that will be published on the web.

Medium Resolution Use for desktop proofs and print-on-demand documents that will be printed on Adobe PostScript color printers.

High Resolution Use for final press output, and for high-quality proofs such as separations-based color proofs.

Note: *The flattening settings are used only if the artwork contains transparency or if Simulate Overprint is selected in the Output area of the Export Adobe PDF dialog box.*

[To the top](#)

Create or edit a transparency flattener preset

You can save transparency flattener presets in a separate file, making it easy to back them up or to make them available to your service providers, clients, or others in your workgroup. In InDesign, transparency flattener preset files have an .flst extension.

1. Choose Edit > Transparency Flattener Presets.
2. Do one of the following:
 - To create a new preset, click New.
 - To base a preset on a predefined preset, select one in the list and click New.
 - To edit an existing preset, select the preset and click Edit.

Note: *You can't edit the default flattener presets.*

3. Set flattening options.
4. Click OK to return to the Transparency Flattener Presets dialog box, and click OK again.

Export and import a custom transparency flattener preset

You can export and import transparency flattener presets in order to share them with your service providers, your clients, or others in your workgroup.

1. Choose Edit > Transparency Flattener Presets.
2. Select a preset in the list.
3. Do one of the following:
 - To export a preset to a separate file, click Save (InDesign) or Export (Illustrator), specify a name and location, and then click Save. Consider saving the preset outside of the application's preferences folder. That way, it won't be lost if you delete your preferences.
 - To import presets from a file, click Load (InDesign) or Import (Illustrator). Locate and select the file containing the preset you want to load, and then click Open.

Rename or delete a custom transparency flattener preset

1. Choose Edit > Transparency Flattener Presets.
2. Select a preset in the list.
3. Do one of the following:
 - To rename an existing preset, click Edit, type a new name, and then click OK.
 - To delete a preset, click Delete, and then click OK to confirm the deletion.

Note: You cannot delete the default presets.

Flatten an individual spread

You can apply flattener settings to individual spreads in a document, overriding the flattener preset you've set for the entire document or book. This is useful for controlling the flattening quality in documents with a mix of high-resolution images with lots of transparency and low-resolution images. In this case, you can flatten the complex spread at a high quality, and use a faster and lower-quality flattener preset on the other spreads.

At print or export time, you can revert to the flattener settings for the document or book.

1. Display the spread in the Document window.
2. Choose Spread Flattening in the Pages panel menu.
3. Choose any of the following, and then click OK:

Default Uses the document flattening preset for this spread.

None (Ignore Transparency) Ignores transparency for the spread. This option is useful for troubleshooting by the service provider.

Custom Opens the Custom Spread Flattener Settings dialog box for specifying settings.

[To the top](#)

Ignore the flattener preset on an individual spread

- Select Ignore Spread Overrides from any of the following locations in InDesign:
 - The Flattener Preview panel (Window > Output > Flattener Preview).
 - The Advanced area of the Print or Export Adobe PDF dialog box.

[To the top](#)

Transparency Flattener options

You can set Transparency Flattener options when creating, editing, or previewing flattener presets in Illustrator, InDesign, or Acrobat.

Highlight (preview) options

None (Color Preview) Disables previewing.

Rasterized Complex Regions Highlights the areas that will be rasterized for performance reasons (as determined by the Rasters/Vectors slider). Keep in mind that the boundary of the highlight area has a higher probability of producing stitching problems (depending on the print-driver settings and the rasterization resolution). To minimize stitching problems, select Clip Complex Regions.

Transparent Objects Highlights the objects that are sources of transparency, such as objects with partial opacity (including images with alpha channels), objects with blending modes, and objects with opacity masks. In addition, note that styles and effects may contain transparency, and overprinted objects may be treated as sources of transparency if they are involved in transparency or if the overprint needs to be flattened.

All Affected Objects Highlights all objects that are involved in transparency, including transparent objects and objects that are overlapped by transparent objects. The highlighted objects will be affected by the flattening process—their strokes or patterns will be expanded, portions of them may get rasterized, and so on.

Affected Linked EPS Files (Illustrator only) Highlights all linked EPS files that are affected by transparency.

Affected Graphics (InDesign only) Highlights all placed content affected by transparency or transparency effects. This option is useful for service providers who need to see graphics that require attention to print properly.

Expanded Patterns (Illustrator and Acrobat) Highlights all patterns that will be expanded if involved in transparency.

Outlined Strokes Highlights all strokes that will be outlined if involved in transparency or because Convert All Strokes To Outlines is selected.

Outlined Text (Illustrator and InDesign) Highlights all text that will be outlined if involved in transparency or because Convert All Text To Outlines is selected.

Note: *In the final output, outlined strokes and text may appear slightly different from native ones, especially very thin strokes and very small text. However, the Flattener Preview doesn't highlight this altered appearance.*

Raster-Fill Text And Strokes (InDesign only) Highlights text and strokes that have rasterized fills as a result of flattening.

All Rasterized Regions (Illustrator and InDesign) Highlights objects and intersections of objects that will be rasterized because there is no other way of representing them in PostScript or because they are more complex than the threshold specified by the Rasters/Vectors slider. For example, the intersection of two transparent gradients will always be rasterized, even if the Rasters/Vectors value is 100. The All Rasterized Regions option also shows raster graphics (such as Photoshop files) involved in transparency, and raster effects such as drop shadows and feathers. Note that this option takes longer to process than the others.

Transparency Flattener Preset options

Name/Preset Specifies the name of the preset. Depending on the dialog box, you can type a name in the Name text box or accept the default. You can enter the name of an existing preset to edit that preset. However, you can't edit the default presets.

Raster/Vector balance Specifies the amount of vector information that will be preserved. Higher settings preserve more vector objects, while lower settings rasterize more vector objects; intermediate settings preserve simple areas in vector form and rasterize complex ones. Select the lowest setting to rasterize all the artwork.

Note: *The amount of rasterization that occurs depends on the complexity of the page and the types of overlapping objects.*

Line Art And Text Resolution Rasterizes all objects, including images, vector artwork, text, and gradients, to the specified resolution. Acrobat and InDesign allow a maximum of 9600 pixels per inch (ppi) for line art, and 1200 ppi for gradient mesh. Illustrator allows a maximum of 9600 ppi for both line art and gradient mesh. The resolution affects the precision of intersections when flattened. Line Art and Text Resolution should generally be set to 600-1200 to provide high-quality rasterization, especially on serif or small point sized type.

Gradient And Mesh Resolution Specifies the resolution for gradients and Illustrator mesh objects rasterized as a result of flattening, from 72 to 2400 ppi. The resolution affects the precision of intersections when flattened. Gradient and mesh resolution should generally be set between 150 and 300 ppi, because the quality of the gradients, drop shadows, and feathers do not improve with higher resolutions, but printing time and file size increase.

Convert All Text To Outlines Converts all type objects (point type, area type, and path type) to outlines and discards all type glyph information on pages containing transparency. This option ensures that the width of text stays consistent during flattening. Note that enabling this option will cause small fonts to appear slightly thicker when viewed in Acrobat or printed on low-resolution desktop printers. It doesn't affect the quality of the type printed on high-resolution printers or imagesetters.

Convert All Strokes To Outlines Converts all strokes to simple filled paths on pages containing transparency. This option ensures that the width of strokes stays consistent during flattening. Note that enabling this option causes thin strokes to appear slightly thicker and may degrade flattening performance.

Clip Complex Regions Ensures that the boundaries between vector artwork and rasterized artwork fall along object paths. This option reduces stitching artifacts that result when part of an object is rasterized while another part of the object remains in vector form. However, selecting this option may result in paths that are too complex for the printer to handle.

Note: *Some print drivers process raster and vector art differently, sometimes resulting in color stitching. You may be able to minimize stitching problems by disabling some print-driver specific color-management settings. These settings vary with each printer, so see the documentation that came with your printer for details.*

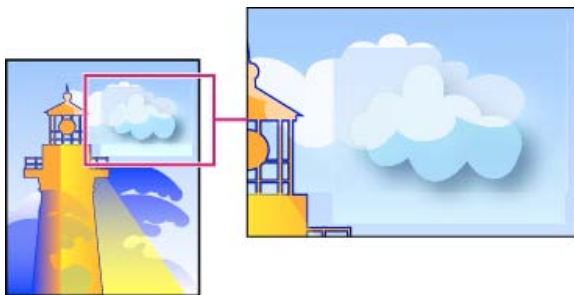

Stitching, where rasters and vectors meet.

(Illustrator only) Select Preserve Alpha Transparency (Flatten Transparency dialog box only) Preserves the overall opacity of flattened objects. With this option, blending modes and overprints are lost, but their appearance is retained within the processed artwork, along with the level of alpha transparency (as when you rasterize artwork using a transparent background). Preserve Alpha Transparency can be useful if you are exporting to SWF or SVG, since both of these formats support alpha transparency.

(Illustrator only) Select Preserve Spot Colors And Overprints (Flatten Transparency dialog box only) Generally preserves spot colors. It also preserves overprinting for objects that aren't involved in transparency. Select this option when printing separations if the document contains spot colors and overprinted objects. Deselect this option when saving files for use in page-layout applications. With this option selected, overprinted areas that interact with transparency are flattened, while overprinting in other areas is preserved. The results are unpredictable when the file is output from a page-layout application.

Preserve Overprint (Acrobat only) Blends the color of transparent artwork with the background color to create an overprint effect.

[To the top](#)

Preview which areas of artwork will be flattened

Use the preview options in the Flattener Preview to highlight areas that are affected by flattening. You can use this color-coded information to adjust flattening options.

Note: *The Flattener Preview is not intended for precise previewing of spot colors, overprints, and blending modes. Instead, use Overprint Preview mode for those purposes.*

1. Display the Flattener Preview panel (or dialog box):

- In Illustrator, choose Window > Flattener Preview.
- In Acrobat, choose Tools > Print Production > Flattener Preview.
- In InDesign, choose Window > Output > Flattener Preview.

2. From the Highlight menu, choose the kind of areas you want to highlight. The availability of options depends on the content of the artwork.

3. Select the flattening settings you want to use: Either choose a preset or, if available, set specific options.

Note: *(Illustrator) If the flattening settings aren't visible, select Show Options from the panel menu to display them.*

4. If the artwork contains overprinted objects that interact with transparent objects, in Illustrator, select an option from the Overprints menu. You can preserve, simulate, or discard overprints. In Acrobat, choose Preserve Overprint to blend the color of transparent artwork with the background color to create an overprint effect.

5. At any time, click Refresh to display a fresh preview version based on your settings. Depending on the complexity of the artwork, you may need to wait a few seconds for the preview image to appear. In InDesign, you can also choose Auto Refresh Highlight.

 *In Illustrator and Acrobat, to magnify the preview, click in the preview area. To zoom out, Alt-click/Option-click in the preview area. To pan the preview, hold down the spacebar and drag in the preview area.*

[To the top](#)

Refresh the preview in the Flattener Preview panel

- To automatically update the display whenever it is out of date and idle, select Auto Refresh Highlight.
- To manually update the display, click Refresh.

In both cases, the display is updated in the document window according to the transparency flattening settings you chose.

[To the top](#)

Best practices when creating transparency

In most cases, flattening produces excellent results when you use an appropriate predefined flattener preset, or create a preset with settings appropriate for your final output. For a complete reference and troubleshooting guide on how transparency affects output, see the document “Achieving Reliable Print Output with Transparency” (English only) on the Adobe website.

However, if your document contains complex, overlapping areas and you require high-resolution output, you can achieve more reliable print output by following a few basic guidelines:

Note: *If you're applying transparency to documents intended for high-resolution output, be sure to discuss your plans with your service provider. Good communication between you and your service provider will help you achieve the results you expect.*

Overprinting objects

Although flattened objects may look transparent, they are actually opaque and don't allow other objects beneath them to show through. However, if you don't apply overprint simulation, the transparency flattener may be able to preserve basic overprinting of objects when exporting to PDF or printing. In this case, recipients of the resulting PDF file should select Overprint Preview in Acrobat 5.0 or later to accurately view the results of overprinting.

Conversely, if you apply overprint simulation, the transparency flattener provides a simulation of what the overprints look like, and this simulation results in all opaque objects. In PDF output, this simulation converts spot colors to process color equivalents. Therefore, Simulate Overprint should not be selected for output that will be color separated later.

Spot colors and blending modes

Using spot colors with certain blending modes sometimes produces unexpected results. This is because InDesign uses process color equivalents on screen, but uses spot colors in print. In addition, isolated blending in an imported graphic could create knockouts in the active document.

If you use blending, check your design periodically using Overprint Preview in the View menu. Overprint Preview gives an approximation of how spot inks that overprint or interact with transparent objects will appear. If the visual effect is not what you want, do any of the following:

- Use a different blending mode or no blending mode. Avoid these blending modes when working with spot colors: Difference, Exclusion, Hue, Saturation, Color, and Luminosity.
- Use a process color where possible.

Blend space

If you apply transparency to objects on a spread, all colors on that spread convert to the transparency blend space you've chosen (Edit > Transparency Blend Space), either Document RGB or Document CMYK, even if they're not involved with transparency. Converting all the colors results in consistency across any two same-colored objects on a spread, and avoids more dramatic color behavior at the edges of transparency. Colors are converted “on the fly” as you draw objects. Colors in placed graphics that interact with transparency are also converted to the blend space. This affects how the colors appear on-screen and in print, but not how the colors are defined in the document.

Depending on your workflow, do one of the following:

- If you create documents for print only, choose Document CMYK for the blend space.
- If you create documents for web only, choose Document RGB.
- If you create documents for both print and web, decide which is more important, and then choose the blend space that matches the final output.
- If you create a high-resolution print piece that you'll also publish as a high-profile PDF document on a website, you may need to switch the blending space back and forth before final output. In this case, be sure to reproof the color on every spread that has transparency, and avoid using the Difference and Exclusion blend modes—these modes can change the appearance dramatically.

Type

When type is close to transparent objects, it may interact with transparent objects in unexpected ways. For example, type that wraps around a transparent object may not actually overlap the object, but the glyphs may be close enough to interact with the transparency. In this case, the flattener may convert the glyphs to outlines, resulting in thickened stroke widths on the glyphs only.

If this happens, do either of the following:

- Move the text to the top of the stacking order. Use the Selection tool to select the text frame, and then choose Object > Arrange > Bring to Front.
- Expand all text to outlines for a consistent effect throughout the document. To expand all text to outlines, select Convert All Text To Outlines in the Transparency Flattener Preset Options dialog box. Selecting this option may affect processing speed.

Image replacement

The flattener requires high-resolution data to accurately process a document with transparency. However, in an OPI proxy workflow, placeholder or proxy images are used, for later replacement with high-resolution versions by an OPI server. If the flattener doesn't have access to the high-resolution data, then no OPI comments are produced and only the low-resolution proxy images are output, resulting in low-resolution images at final output.

If you work in an OPI workflow, consider using InDesign to substitute images before saving the document as PostScript. To do this, you must specify settings both when you place the EPS graphic and when you output it. When you place the EPS graphic, select Read Embedded OPI Image Links in the EPS Import Options dialog box. When you output, select OPI Image Replacement in the Advanced area of either the Print or Export EPS dialog box.

Color conversions

If a transparent object overlaps a spot color object, undesirable results may occur when you export to EPS format, and then convert spot colors to process colors upon printing or create color separations in an application other than InDesign.

To prevent problems in these cases, use the Ink Manager to convert spot colors to process color equivalents as necessary prior to exporting from InDesign. Another way to prevent problems is to make sure that your spot inks are consistent in both the original application (for example, Adobe Illustrator) and InDesign. This may mean that you'll need to open an Illustrator document, convert a spot color to process color, export it again to EPS, and then place the EPS file in your InDesign layout.

Adobe PDF files

Exporting to Acrobat 4.0 (Adobe PDF 1.3) always flattens a document with transparency, which may affect the appearance of its transparent objects. Nontransparent content is not flattened unless Simulate Overprint is selected in the Output area of the Export Adobe PDF dialog box. Therefore, when you export an InDesign document with transparency to Adobe PDF, do any of the following:

- Whenever possible, choose Acrobat 5.0 (Adobe PDF 1.4), Acrobat 6.0 (Adobe PDF 1.5), or Acrobat 7.0 (Adobe PDF 1.6) compatibility in the Export Adobe PDF dialog box to preserve transparency in a live and fully editable form. Make sure that your service provider can handle Acrobat 5.0, Acrobat 6.0, or Acrobat 7.0 files.
- If you must use Acrobat 4.0 compatibility, your document contains spot colors, and you want to create a PDF file for on-screen viewing (such as a client review), you may want to select the Simulate Overprint option in the Output area of the Export Adobe PDF dialog box. This option properly simulates the spot and transparent areas; recipients of the PDF file won't have to select Overprint Preview in Acrobat to see how the document will look when printed. However, the Simulate Overprint option converts all spot colors to process color equivalents in the resulting PDF file, so be sure to deselect this option when you create the PDF for final production.
- Consider using the predefined [Press Quality] Adobe PDF preset. This preset contains flattener settings appropriate for complex documents intended for high-resolution output.

Trapping

Flattening may convert vectors to rasterized areas. Traps applied to artwork in Adobe Illustrator using strokes and placed in InDesign will be preserved. Traps applied to vector artwork drawn in InDesign and then rasterized may not be preserved.

To keep as many objects vector as possible, select the [High Resolution] transparency flattener preset in the Advanced area of the Print or Export Adobe PDF dialog box.

Adobe also recommends



Twitter™ and Facebook posts are not covered under the terms of Creative Commons.

[Legal Notices](#) | [Online Privacy Policy](#)

Blending colors

[Specify how colors blend](#)

[Isolate blending modes](#)

[Knock out objects within a group](#)

[Specify a color space for blending transparent objects](#)

[To the top](#)

Specify how colors blend

Blend the colors between two overlapping objects by using blending modes. Blending modes let you vary the ways in which the colors of stacked objects blend.

1. Select one or more objects or a group.
2. Do one of the following:
 - In the Effects panel, choose a blending mode, such as Normal or Overlay, from the menu.
 - In the Transparency area of the Effects dialog box, choose a blending mode from the menu.

Blending mode options

The blending modes control how the *base color*, the underlying color in the artwork, interacts with the *blend color*, the color of the selected object or group of objects. The *resulting color* is the color resulting from the blend.

Normal Colors the selection with the blend color, without interaction with the base color. This is the default mode.

Multiply Multiplies the base color by the blend color. The resulting color is always a darker color. Multiplying any color with black produces black. Multiplying any color with white leaves the color unchanged. The effect is similar to drawing on a page with multiple magic markers.

Screen Multiplies the inverse of the blend and base colors. The resulting color is always a lighter color. Screening with black leaves the color unchanged. Screening with white produces white. The effect is similar to projecting multiple slide images on top of each other.

Overlay Multiplies or screens the colors, depending on the base color. Patterns or colors overlay the existing artwork, preserving the highlights and shadows of the base color while mixing in the blend color to reflect the lightness or darkness of the original color.

Soft Light Darkens or lightens the colors, depending on the blend color. The effect is similar to shining a diffused spotlight on the artwork. If the blend color (light source) is lighter than 50% gray, the artwork is lightened, as if it were dodged. If the blend color is darker than 50% gray, the artwork is darkened, as if it were burned in. Painting with pure black or white produces a distinctly darker or lighter area, but does not result in pure black or white.

Hard Light Multiplies or screens the colors, depending on the blend color. The effect is similar to shining a harsh spotlight on the artwork. If the blend color (light source) is lighter than 50% gray, the artwork is lightened, as if it were screened. This is useful for adding highlights to artwork. If the blend color is darker than 50% gray, the artwork is darkened, as if it were multiplied. This is useful for adding shadows to artwork. Painting with pure black or white results in pure black or white.

Color Dodge Brightens the base color to reflect the blend color. Blending with black produces no change.

Color Burn Darkens the base color to reflect the blend color. Blending with white produces no change.

Darken Selects the base or blend color—whichever is darker—as the resulting color. Areas lighter than the blend color are replaced, and areas darker than the blend color do not change.

Lighten Selects the base or blend color—whichever is lighter—as the resulting color. Areas darker than the blend color are replaced, and areas lighter than the blend color do not change.

Difference Subtracts either the blend color from the base color or the base color from the blend color, depending on which has the greater brightness value. Blending with white inverts the base color values; blending with black produces no change.

Exclusion Creates an effect similar to, but lower in contrast than, the Difference mode. Blending with white inverts the base color components. Blending with black produces no change.

Hue Creates a color with the luminance and saturation of the base color and the hue of the blend color.

Saturation Creates a color with the luminance and hue of the base color and the saturation of the blend color. Painting with this mode in an area with no saturation (gray) produces no change.

Color Creates a color with the luminance of the base color and the hue and saturation of the blend color. This preserves the gray levels in the artwork, and is useful for coloring monochrome artwork and for tinting color artwork.

Luminosity Creates a color with the hue and saturation of the base color and the luminance of the blend color. This mode creates an inverse effect from that of the Color mode.

Note: Avoid applying the Difference, Exclusion, Hue, Saturation, Color, and Luminosity blending modes to objects with spot colors; doing so can add unwanted colors to a document. For more information, see [Best practices when creating transparency](#).

[To the top](#)

Isolate blending modes

When you apply a blending mode to an object, its colors blend with all objects beneath it. If you want to limit the blending to specific objects, you can group those objects and then apply the Isolate Blending option to the group. The Isolate Blending option confines the blending to within the group, preventing objects beneath the group from being affected. (It is useful for objects that have a blending mode other than Normal applied to them.)

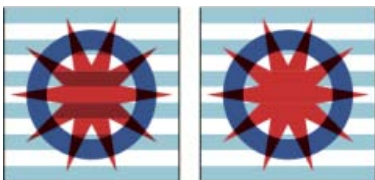

Group (star and circle) with Isolate Blending option deselected (left) compared to selected (right)

It is important to understand that you apply the blending modes to the individual objects, but apply the Isolate Blending option to the group. The option isolates blending interactions within the group. It doesn't affect blending modes applied directly to the group itself.

1. Apply the blending modes and opacity settings to the individual objects whose blending you want to isolate.
2. Using the Selection tool, select the objects you want to isolate.
3. Choose Object > Group.

4. In the Effects panel, select Isolate Blending. (If the option is not visible, select Show Options in the Effects panel menu.)

 You can isolate the blending of objects in a PDF file that contains blending modes. First, place the PDF file with the Transparent Background option selected in the Place PDF dialog box. Then apply the Isolate Blending option.

[To the top](#)

Knock out objects within a group

You use the Knockout Group option in the Effects panel to make the opacity and blending attributes of every object in the selected group *knock out*—that is, visually block out—underlying objects in the group. Only objects within the selected group are knocked out. Objects beneath the selected group are still affected by the blending or opacity that you apply to objects within the group.

It is important to understand that you apply the blending modes and opacity to the individual objects, but apply the Knockout Group option to the group.

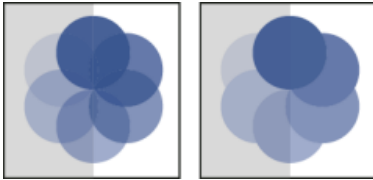

Group with Knockout Group option deselected (left) compared to selected (right)

1. Apply the blending modes and opacity settings to the individual objects that you want to knock out.
2. Using the Selection tool, select the objects that you want to knock out.
3. Choose Object > Group.
4. In the Effects panel, select Knockout Group. (If the option is not visible, select Show Options in the Effects panel menu.)

[To the top](#)

Specify a color space for blending transparent objects

To blend the colors of transparent objects on a spread, InDesign converts the colors of all objects to a common color space using either the CMYK or RGB color profile for the document. This blending space enables objects of multiple color spaces to blend when interacting transparently. To avoid color mismatches between different areas of the objects on screen and in print, the blending space is applied for screen and in the flattener.

The blending space is applied only to those spreads that contain transparency.

- Choose Edit > Transparency Blend Space, and then choose one of the document's color spaces.

Note: For a typical print workflow, choose the Document CMYK color space.

Adobe also recommends

 Twitter™ and Facebook posts are not covered under the terms of Creative Commons.

[Legal Notices](#) | [Online Privacy Policy](#)

Exporting and publishing

[Build digital magazines with InDesign CS5.5 and Adobe Digital Publishing Suite \(video 09:06\)](#)

Terry White (May. 7, 2012)

video-tutorial

In this video, see you how to create immersive digital magazines for tablet devices using InDesign.

[Adding audio and video content to EPUB \(video 02:46\)](#)

Colin Fleming (Jan. 1, 2011)

video-tutorial

In this video tutorial, see how simple it is to embed audio and video content in InDesign CS5.5 and later, for export to EPUB.

[Controlling order of content export from InDesign to EPUB without changing your layout \(video 04:54\)](#)

Colin Fleming (Jan. 1, 2011)

video-tutorial

Learn how to create and organize articles in the Articles panel for export to EPUB, without changing layout or writing code.

[Creating covers and title pages for EPUB \(video 05:50\)](#)

Colin Fleming (Jan. 1, 2011)

video-tutorial

Learn how to create covers and title pages for your EPUB titles.

[Exploring new FLA export options \(video 6:26\)](#)

Anne-Marie Concepcion (Jan. 1, 2011)

video-tutorial

See how to publish your InDesign project in a variety of Flash formats by using the enhanced Export dialog box in InDesign CS5 and later.

[Exporting documents to EPUB \(PDF, 265 KB\)](#)

article (Jan. 1, 2011)

A short and quick overview on how to export your layouts to EPUB in InDesign CS5.

[Exporting to EPUB for the Apple iBookstore \(PDF, 2.5 MB\)](#)

article (Jan. 1, 2011)

Learn how to create an EPUB for the Apple iBook store

[Setting object export options \(PDF, 160 KB\), CS5.5 and later](#)

article (Jan. 1, 2011)

How to use the Object Export options to streamline your export workflow.

[Styles mapped to tags in InDesign for improved EPUB export \(video 05:13\)](#)

Colin Fleming (Jan. 1, 2011)

video-tutorial

In InDesign CS5.5 and later, you can map paragraph and character styles directly to EPUB, HTML and PDF tags to ensure that styles you define in InDesign are exported appropriately. You can also add CSS class names and type n your own custom tags.

[Using Object Export options to customize how objects and images export to EPUB \(video 05:18\)](#)

Colin Fleming (Jan. 1, 2011)

video-tutorial

Use Object Export Options to customize how objects and images are exported to EPUB to ensure best viewing results on any screen - no matter what size.

Export content for EPUB | CC

- [Overview](#)
- [Export to EPUB](#)
- [EPUB Export options](#)
- [EPUB resources](#)

[To the top](#)

Overview

Before you export your layout to EPUB, you can make a few tweaks to ensure that it exports properly.

- **Add anchored graphics** - Anchor graphics in text flows so that you can control their position relative to the exported text. See [Anchored Objects](#).
- **Object Export Options** - Specify export options for placed objects. See [Object Export Options](#).
- **Choose content and order** - Use the Articles panel to choose the content to export and order in which it should appear. See [Articles](#). You can also order content based on page layout or the XML structure.

[To the top](#)

Export to EPUB

You can export a document or book as a reflowable eBook in EPUB format that is compatible with eBook reader software.

1. Do one of the following:
 - Open the document and choose File > Export.
 - Open a book and from the Book panel menu, choose Export Book to EPUB.
2. Specify a filename and location.
3. From the Save as Type list choose EPUB, and then click Save.
4. In the EPUB Export Options dialog box, specify the desired options in the General, Image, and Advanced areas, and then click OK.

InDesign creates a single .epub file containing the XHTML-based content. If specified, the exported file may include a cover image. The cover image is created from an image, or created by rasterizing the first page in the specified document (or the style source document if a book was selected). The thumbnail is used to depict the book in the EPUB readers or the Digital Editions Reader library view. To view the file, you need an EPUB reader. You can also use the Adobe Digital Editions software, which you can download free from the Adobe website.

 *The .epub file is essentially a .zip file. To view and edit the contents of an EPUB file, change the extension from .epub to .zip, and then extract the contents. This is especially useful for editing the CSS file.*

Note: InDesign objects such as text frames and objects that contain placed images are always exported when you choose the Based on Page Layout ordering option. Empty objects are not exported unless you have applied a setting to the InDesign object via the Object Export Options to make it export as a JPEG, GIF, or PNG.

[To the top](#)

EPUB Export options

EPUB General options

The General section of the EPUB Export Options dialog box includes the following options.

Version Specify a version for the EPUB.

EPUB 2.0.1 EPUB 2.0.1 is a standard approved by IDPF in 2007. This format is supported on a wide variety of devices.

EPUB 3.0 EPUB 3.0 is a standard approved by IDPF in 2011. This format also supports audio, video, javascript, Japanese vertical text. The new features however will not work on readers and devices that do not support EPUB 3.0 standard.

Cover Specifies the cover image for the eBook. Choose one of the following:

None If this option is selected no cover image is added to the eBook.

Rasterize First Page If this option is selected creates an image file by rasterizing the first page of the eBook to use as the cover.

Choose image If this option is selected you can specify an image on your computer to use as the cover.

Navigation Specify navigation option for EPUB Viewer TOC: either you can use a TOC style to create the sidebar navigation or use the filename.

File Name Select this option if you want to generate a table of contents based on the filenames. For creating a TOC by filename, you must also specify a paragraph style on which you want to split the exported file (Advanced > Split Document > select a style).

TOC Style Select this option if you want to generate a table of contents based on the selected TOC style. From the TOC Style menu, specify the TOC style you want to use to build the table of contents in the eBook. You can choose Layout > Table Of Contents Styles to create a special TOC style for your eBook.

Margins Specify values for the Top, Bottom, Left, and Right margins in pixels. To use the same value for each margin, click the Constrain icon.

Content Order Specify the order in which page elements are exported

Based on Page Layout The location of the items on the page determines the reading order.

If Based On Page Layout is selected, InDesign determines the reading order of page objects by scanning left to right and top to bottom. In some instances, especially in complex, multicolumn documents, the design elements may not appear in the desired reading order. Use Dreamweaver to rearrange and format the contents.

(Asian versions only) If Based On Page Layout is selected, InDesign determines the reading order of page objects according to the document's binding (left to right or right to left). In some instances, especially in complex, multicolumn documents, the exported design elements may not appear in the desired reading order. Use Dreamweaver to rearrange and format the contents.

Same as XML Structure The order of the tags in Structure View determines the reading order. See [Tag page items](#).

Same as Articles panel The order of elements in the Articles panel determines the reading order. Only the checked articles are exported. See Include articles for export.

Place Footnote After Paragraph Check to place footnotes after the paragraph. If deselected, footnotes are converted to endnotes.

Remove Forced Line Breaks Check to remove all soft-returns in the exported eBook.

Bullets Select Map To Unordered List to convert bullet paragraphs into List Items, which are formatted in HTML using the tag. Select Convert To Text to format using the <p> tag with bullet characters as text. If you have used native InDesign auto-bullets, subbullets are also included.

Numbers Determines how numbers are converted in the HTML file. If you have used native InDesign auto-numbering, subbullets are also included

Map To Ordered List Converts numbered lists into List Items, which are formatted in HTML using the tag.

Convert To Text Converts numbered lists into paragraphs that begin with the paragraph's current number as text.

View EPUB After Exporting Opens the EPUB in the default application selected for reading EPUB, if present.

EPUB Image options

The Image section of the EPUB Export options dialog box includes the following options. From the Image Conversion menu, determine how images are exported to HTML.

Preserve Appearance from Layout Check to inherit the image object attributes from the layout.

Resolution (ppi) Choose the resolution of the images in pixels per inch (ppi). While operating systems have standardized on either 72 ppi or 96 ppi, mobile devices range from 132 ppi (iPad), to 172 ppi (Sony Reader), to over 300 ppi (iPhone 4). You can choose a ppi value for each object selected. Values include 72, 96, 150 (average for all eBook devices today), and 300.

Image Size Specify if image size must remain fixed or resized relative to the page. Relative to Page Size sets a relative percentage value based on the size of the image relative to the InDesign page width. This option causes the images to rescale proportionally, relative to the width of the reading area.

Image Alignment and Spacing Specify the image alignment - left, center, and right. You can also specify the top and bottom padding.

Insert Page Break Check to insert page breaks with images. Page breaks can be inserted Before Image, After Image, or Before and After Image.

Settings Apply to Anchored Objects Check to apply these settings to all anchored objects.

Image Conversion Lets you choose whether the optimized images in your document are converted to GIF, JPEG, or PNG. Choose Automatic to let InDesign decide which format to use in each instance. Choosing PNG disables the image compression settings; use PNG for lossless images or for images that include transparency.

GIF Options (Palette) Lets you control how InDesign handles colors when optimizing GIF files. The GIF format uses a limited color palette, which cannot exceed 256 colors.

Choose Adaptive to create a palette using a representative sample of colors in the graphic without any dithering (mixing of small spots of colors to simulate additional colors). Choose Web to create a palette of web-safe colors that are a subset of Windows and Mac OS system colors. Choose System (Win) or System (Mac) to create a palette using the built-in system color palette. This choice may cause unexpected results.

Select Interlace to load the images progressively by filling in missing lines. If this option is not selected, an image looks fuzzy and gradually becomes clear as the image reaches full resolution.

JPEG Options (Image Quality) Determines the trade-off between compression (for smaller file sizes) and image quality for each JPEG image created. Low produces the smallest file and lowest image quality.

JPEG Options (Format Method) Determines how quickly JPEG graphics display when the file containing the image is opened on the web. Choose Progressive to make the JPEG images display gradually and in increasing detail as they are downloaded. (Files created with this option are slightly larger and require more RAM for viewing.) Choose Baseline to make each JPEG file display only after it has been downloaded; a placeholder appears in its place until the file is displayed.

Ignore Object Export Settings Ignore Object Export settings applied on individual images. See [Apply Object export options](#).

EPUB Advanced options

The Contents section of the EPUB Options dialog box includes the following options.

Split Document You can split the eBook at the specified paragraph style. Splitting results in a larger number of HTML files in the EPUB package, but can be helpful for breaking up long files and increases performance in the EPUB readers.

Include Document Metadata The metadata from the document (or the style source document if a book was selected) is included with the exported file.

Publisher Specify the publisher information that appears in the eBook metadata. You can specify a URL for the publisher so that someone who receives the eBook can visit the publisher's website.

Unique ID Every EPUB document requires a unique identifier. A unique identifier is automatically created and displayed. You can remove it and specify a unique identifier.

CSS Options Cascading Style Sheets (CSS) are a collection of formatting rules that control the appearance of content in a web page. When you use CSS to format a page, you separate content from presentation.

Generate CSS Specify whether you want InDesign to generate a CSS for the exported file. If you export your document/book to EPUB without generating a CSS, only the classes associated with the styles are marked in the HTML tags; no overriding classes are created. This is very useful if you want to use an external CSS with the exported file.

Preserve Local Overrides If this option is selected, local formatting such as italic or bold is included.

Include Embeddable Fonts Includes all fonts that are embeddable, in the eBook. Fonts include *embedding bits* that determine if the font is embeddable.

Add Style Sheet Specify the URL of the existing CSS style sheet, which is usually a relative URL, such as "/styles/style.css." InDesign does not check whether the CSS exists or is valid. You can use Dreamweaver to confirm your external CSS setup.

Add Script Specify the URL of an existing JavaScript. InDesign does not check whether the JavaScript exists or is valid, so you'll want to confirm your JavaScript setup.

[To the top](#)

EPUB resources

Use the following links to learn about EPUB format.

- For more information on the EPUB specification, see www.idpf.org.
- Download a free copy of the Digital Editions reader at www.adobe.com/products/digitaleditions.
- See the blog [Digital Editions](#) for information on Digital Editions.
- For information on exporting to Kindle, see the [InDesign to Kindle white paper](#) (PDF).
- Learn how to convert your InDesign files to the EPUB format and start selling your eBooks for viewing on the Apple iPad. See the [InDesign to iPad white paper](#).

Export content to HTML | CC

Exporting to HTML is an easy way to get your InDesign content into web-ready form. When you export content to HTML, you can control how text and images are exported. InDesign preserves the names of paragraph, character, object, table, and cell styles applied to the exported contents by marking the HTML contents with CSS style classes of the same name. Using Adobe Dreamweaver or any CSS-capable HTML editor, you can quickly apply formatting and layout to the contents.

What gets exported InDesign exports all stories, linked and embedded graphics, SWF movie files, footnotes, text variables (as text), bulleted and numbered lists, internal cross-references, and hyperlinks that jump to text or web pages. Tables are also exported, but certain formatting, such as table and cell strokes, is not exported. Tables are assigned unique IDs, so they can be referenced as Spry data sets in Dreamweaver. Placed audio and h.264 video files are enclosed in HTML5 <audio> and <video> tags.

What doesn't get exported InDesign does not export objects you draw (such as rectangles, ovals, and polygons), hyperlinks (except for links to web pages and links applied to text that jump to text anchors in the same document), pasted objects (including pasted Illustrator images), text converted to outlines, XML tags, books, bookmarks, SING glyphlets, page transitions, index markers, objects on the pasteboard that aren't selected and don't touch the page, or master page items (unless they're overridden or selected before export).

1. If you're not exporting the entire document, select the text frames, range of text, table cells, or graphics you want to export.
2. Choose File > Export and select HTML from the Save As Type list.
3. Specify the name and location of the HTML document, and then click Save.
4. In the HTML Export Options dialog box, specify the desired options in the General, Image, and Advanced areas, and then click OK.

A document with the specified name and an .html extension (such as "newsletter.html") is created; if specified, a web images subfolder (such as "newsletter-web-images") is saved in the same location.

HTML export options

In the HTML dialog box, specify the following options.

General options

The General area includes the following options.

Export Determines whether only the selected items or the entire document is exported. If a text frame is selected, the entire story—including overset text—is exported.

If Document is selected, all page items from all spreads are exported, except for master page items that have not been overridden and page items on invisible layers. XML tags and generated indexes and tables of contents are also ignored.

Content Order / Ordering lets you specify the reading order of page objects.

Based On Page Layout

The location of the items on the page determines the reading order.

If Based On Page Layout is selected, InDesign determines the reading order of page objects by scanning left to right and top to bottom. In some instances, especially in complex, multicolumn documents, the design elements may not appear in the desired reading order. Use Dreamweaver to rearrange and format the contents.

(Asian versions only) If Base On Page Layout is selected, InDesign determines the reading order of page objects according to the document's binding (left to right or right to left). In some instances, especially in complex, multicolumn documents, the exported design elements may not appear in the desired reading order. Use Dreamweaver to rearrange and format the contents.

Same As XML Structure

If Same As XML Structure is selected, the XML Structure panel controls the ordering of the exported content and which content gets exported. If your content is already tagged, you can simply drag the tags in the XML Structure panel to set the XHTML Export order. If your content is not tagged, you can choose Add Untagged Items from the Structure panel menu to generate tags that you can reorder. If you do not want an item to be included in the export, you can simply delete the tag in the XML Structure panel. (Deleting a tag does not delete the content from the INDD file.) See [Tag page items](#).

Same As Articles Panel

The order of elements in the Articles panel determines the reading order. Only the checked articles are exported. See [Include articles for export](#).

Bullets Select Map To Unordered List to convert bullet paragraphs into List Items, which are formatted in HTML using the tag. Select Convert To Text to format using the <p> tag with bullet characters as text. If you have used native InDesign auto-bullets, subbullets are also included.

Numbers Determines how numbers are converted in the HTML file. If you have used native InDesign auto-numbering, subbullets are also included.

Map To Ordered List Converts numbered lists into List Items, which are formatted in HTML using the tag.

Convert To Text Converts numbered lists into paragraphs that begin with the paragraph's current number as text.

View HTML After Exporting Starts the browser, if present.

Image options

Copy Images Specify how images are exported to HTML.

Original Exports the original image to the "<document_name>-web-images" subfolder. When this option is selected, all other options are dimmed.

Optimized Lets you change settings to determine how the image is exported.

Link To Server Path Rather than exporting images to a subfolder, this option lets you enter a local URL (such as "images/") that appears in front of the image file. In the HTML code, the link attribute displays the path and extension you specify. This option is especially effective when you're converting images to web-compatible images yourself.

Preserve Appearance from Layout Check to inherit the image object attributes from the layout.

Resolution (ppi) Choose the resolution of the images in pixels per inch (ppi). While operating systems have standardized on either 72 ppi or 96 ppi, mobile devices range from 132 ppi (iPad), to 172 ppi (Sony Reader), to over 300 ppi (iPhone 4). You can choose a ppi value for each object selected. Values include 72, 96, 150 (average for all eBook devices today), and 300.

Image Size Specify if image size must remain fixed or resized relative to the page. Relative to Page Size sets a relative percentage value based on the size of the image relative to the InDesign page width. This option causes the images to rescale proportionally, relative to the width of the reading area.

Image Alignment and Spacing Specify the image alignment - left, center, and right. You can also specify the top and bottom padding.

Settings Apply to Anchored Objects Check to apply these settings to all anchored objects.

Image Conversion Lets you choose whether the optimized images in your document are converted to GIF, JPEG, or PNG. Choose Automatic to

let InDesign decide which format to use in each instance. Choosing PNG disables the image compression settings.; use PNG for lossless images or for images that include transparency.

GIF Options (Palette) Lets you control how InDesign handles colors when optimizing GIF files. The GIF format uses a limited color palette, which cannot exceed 256 colors.

Choose Adaptive to create a palette using a representative sample of colors in the graphic without any dithering (mixing of small spots of colors to simulate additional colors). Choose Web to create a palette of web-safe colors that are a subset of Windows and Mac OS system colors. Choose System (Win) or System (Mac) to create a palette using the built-in system color palette. This choice may cause unexpected results.

Select Interlace to load the images progressively by filling in missing lines. If this option is not selected, an image looks fuzzy and gradually becomes clear as the image reaches full resolution.

JPEG Options (Image Quality) Determines the trade-off between compression (for smaller file sizes) and image quality for each JPEG image created. Low produces the smallest file and lowest image quality.

JPEG Options (Format Method) Determines how quickly JPEG graphics display when the file containing the image is opened on the web. Choose Progressive to make the JPEG images display gradually and in increasing detail as they are downloaded. (Files created with this option are slightly larger and require more RAM for viewing.) Choose Baseline to make each JPEG file display only after it has been completely downloaded; a placeholder appears in its place until the file is displayed.

Ignore Object Export Settings Ignores Object Export Options applied on individual images. See [Apply Object export options](#).

Advanced options

Use the Advanced area to set CSS and JavaScript options.

CSS Options Cascading Style Sheets (CSS) are a collection of formatting rules that control the appearance of content in a web page. When you use CSS to format a page, you separate content from presentation. The content of your page—the HTML code—resides in the HTML file itself, while the CSS rules defining the presentation of the code reside in another file (an external style sheet) or within the HTML document (usually in the Head section). For example, you can specify different font sizes for selected text, and you can use CSS to control the format and positioning of block-level elements in a web page.

Generate CSS Specify whether you want InDesign to generate a CSS for the exported file. If you select the Generate CSS option, you can also select the Preserve Local Overrides option to include the local formatting such as italic or bold.

Add Style Sheet Specify the URL of the existing CSS style sheet, which is usually a relative URL, such as “/styles/style.css.” InDesign does not check whether the CSS exists or is valid. You can use Dreamweaver to confirm your external CSS setup.

JavaScript Options Select Link To External JavaScript to run a JavaScript when the HTML page is opened. Specify the URL of the JavaScript, which is usually a relative URL. InDesign does not check whether the JavaScript exists or is valid.

 Twitter™ and Facebook posts are not covered under the terms of Creative Commons.

[Legal Notices](#) | [Online Privacy Policy](#)

Exporting to Adobe PDF

- [About Adobe PDF](#)
- [Export to PDF for printing](#)
- [Adobe PDF presets](#)
- [Customize Adobe PDF presets](#)
- [Load Adobe PDF presets](#)
- [Background Tasks panel](#)

[To the top](#)

About Adobe PDF

Portable Document Format (PDF) is a universal file format that preserves the fonts, images, and layout of source documents created on a wide range of applications and platforms. Adobe PDF is the standard for the secure, reliable distribution and exchange of electronic documents and forms around the world. Adobe PDF files are compact and complete, and can be shared, viewed, and printed by anyone with free Adobe Reader® software.

Adobe PDF is highly effective in print publishing workflows. By saving a composite of your artwork in Adobe PDF, you create a compact, reliable file that you or your service provider can view, edit, organize, and proof. Then, at the appropriate time in the workflow, your service provider can either output the Adobe PDF file directly, or process it using tools from various sources for such post-processing tasks as preflight checks, trapping, imposition, and color separation.

When you save in Adobe PDF, you can choose to create a PDF/X-compliant file. PDF/X (Portable Document Format Exchange) is a subset of Adobe PDF that eliminates many of the color, font, and trapping variables that lead to printing problems. PDF/X may be used wherever PDFs are exchanged as digital masters for print production—whether at the creation or output stage of the workflow, as long as the applications and output devices support PDF/X.

Adobe PDFs can solve the following problems associated with electronic documents:

Common problem	Adobe PDF solution
Recipients can't open files because they don't have the applications used to create the files.	Anyone, anywhere can open a PDF. All you need is the free Adobe Reader software.
Combined paper and electronic archives are difficult to search, take up space, and require the application in which a document was created.	PDFs are compact and fully searchable, and can be accessed at any time using Reader. Links make PDFs easy to navigate.
Documents appear incorrectly on handheld devices.	Tagged PDFs allow text to reflow for display on mobile platforms such as Palm OS®, Symbian™, and Pocket PC® devices.
Documents with complex formatting are not accessible to visually impaired readers.	Tagged PDFs contain information on content and structure, which makes them accessible on-screen readers.

[To the top](#)

Export to PDF for printing

Exporting a document or book to Adobe PDF is as simple as using the default High Quality Print settings, or as customized as you need it to be to suit your task. The PDF export settings you specify are saved with the application, and will apply to every new InDesign document or book you export to PDF until you change them again. To quickly apply custom settings to PDF files, you can use presets.

You can export a document, a book, or selected documents in a book as a single PDF file. You can also copy content from your InDesign layout to the Clipboard, and automatically create an Adobe PDF file of that content. (This is useful for pasting a PDF file into another application, such as

Adobe Illustrator.)

When you export an InDesign file to PDF, you can preserve navigation elements such as table of contents and index entries, and interactivity features such as hyperlinks, bookmarks, media clips, and buttons. You also have the option of exporting hidden layers, nonprinting layers, and nonprinting objects to PDF. If you're exporting a book, you can merge identically named layers by using the Book panel.

For information on creating accessible PDF documents, see [Adobe InDesign accessibility](#).

Export an open document to PDF for printing

1. Choose File > Export.
2. Specify a name and location for the file.
3. For Save As Type (Windows) or Format (Mac OS), choose Adobe PDF (Print), and then click Save.

When you select the Adobe PDF (Print) option, you cannot include interactive elements in the PDF. To export an interactive document to PDF, see [Create interactive documents for PDF](#).

4. Do one of the following:
 - To use a predefined set of job options, choose a preset from the Adobe PDF Preset menu.
 - To create a PDF/X file, either choose a PDF/X preset from the Adobe PDF Preset menu, or choose a predefined PDF/X format from the Standard menu.
 - To customize options, select a category from the list on the left and then set the options.
5. For Compatibility, choose the lowest PDF version necessary to open the files you create.
6. Click Export (Windows) or Save (Mac OS).

 *To reset options to the default, in the Export Adobe PDF dialog box, hold down Alt (Windows) or Option (Mac OS) and click Reset. (The Cancel button changes to Reset.)*

Prepare layers before exporting a book to PDF

When you export a book to PDF, you can show and hide InDesign layers in the PDF document. To avoid duplication of layer names in the PDF, you can merge the layers on export.

If the Merge Identically Named Layers On Export option is selected, layer names appear under the same book name in Acrobat or Reader. If this option is not selected, layer names appear separately under each document name.

1. If you don't want certain layers to be merged, give them unique names in each book document.

Layer names are case-sensitive, so "Art" and "art" layers are not merged.

2. In the Book panel menu, select Merge Identically Named Layers On Export.

Note: When you export the book to PDF, make sure that Create Acrobat Layers is selected. To select this option, you must use Acrobat 6 (PDF 1.5) or later compatibility.

Export a book to PDF

1. Do one of the following:
 - To create a PDF of the entire book, click in a blank area of the Book panel to deselect any selected documents, and choose Export Book To PDF in the Book panel menu.
 - To create a PDF of documents within a book, select the document or documents in the Book panel, and choose Export Selected Documents To PDF in the Book panel menu.
2. Specify a name and location for the PDF file, and then click Save.
3. Either choose a preset from the Adobe PDF Preset menu, or select a category from the list on the left of the Export Adobe PDF dialog box, and then customize the options.
4. Click Export (Windows) or Save (Mac OS).

Reducing the size of PDFs

For PDF files that are intended to be distributed for viewing purposes only, you may want to reduce the size of PDF files when you export from InDesign. Here are some of the size reduction techniques you can use in the Export Adobe PDF dialog box:

- Choose [Smallest File Size] from the Adobe PDF Preset menu.
- In the Compression area, downsample images to 72 pixels per inch, select automatic compression, and select either low- or medium-image quality for color and grayscale images. When you work with photographic images, use Automatic (JPEG 2000) compression; when you work with images that are mostly solid color, such as charts and graphs, use ZIP compression.
- In the Output area, use the Ink Manager to convert spot colors to process colors.

 *To reduce the size of PDFs, simply open the PDF in Acrobat 8.0 or later, choose Document > Reduce File Size, and then specify the compatibility level. For greater control, choose Advanced > PDF Optimizer.*

For more information on reducing the size of PDF files, see Acrobat Help and the Adobe website.

[To the top](#)

Adobe PDF presets

A PDF *preset* is a group of settings that affect the process of creating a PDF. These settings are designed to balance file size with quality, depending on how the PDF will be used. Most predefined presets are shared across Adobe Creative Suite components, including InDesign, Illustrator, Photoshop, and Acrobat. You can also create and share custom presets for your unique output requirements.

A few of the presets listed below are not available until you move them—as needed—from the Extras folder (where they are installed by default) to the Settings folder. Typically, the Extras and Settings folders are found in (Windows Vista and Windows 7) ProgramData\Adobe\AdobePDF, (Windows XP) Documents and Settings\All Users\Application Data\Adobe\Adobe PDF, or (Mac OS) Library/Application Support/Adobe PDF. Some presets are not available in some Creative Suite components.

The custom settings are found in (Windows XP) Documents and Settings/[username]/Application Data/Adobe/Adobe PDF/Settings, (Windows Vista and Windows 7) Users/[username]/AppData/Roaming/Adobe/Adobe PDF/Settings, or (Mac OS) Users/[username]/Library/Application Support/Adobe/Adobe PDF/Settings.

 *Review your PDF settings periodically. The settings do not automatically revert to the default settings. Applications and utilities that create PDFs use the last set of PDF settings defined or selected.*

High Quality Print Creates PDFs for quality printing on desktop printers and proofing devices. This preset uses PDF 1.4, downsamples color and grayscale images to 300 ppi and monochrome images to 1200 ppi, embeds subsets of all fonts, leaves color unchanged, and does not flatten

transparency (for file types capable of transparency). These PDFs can be opened in Acrobat 5.0 and Acrobat Reader 5.0 and later. In InDesign, this preset also creates tagged PDFs.

Illustrator Default (Illustrator only) Creates a PDF in which all Illustrator data is preserved. PDFs created with this preset can be reopened in Illustrator without any loss of data.

Oversized Pages (Acrobat only) Creates PDFs suitable for viewing and printing of engineering drawings larger than 200 x 200 inches. These PDFs can be opened in Acrobat and Reader 7.0 and later.

PDF/A-1b: 2005 (CMYK and RGB) (Acrobat only) Used for long-term preservation (archival) of electronic documents. PDF/A-1b uses PDF 1.4 and converts all colors to either CMYK or RGB, depending on which standard you choose. These PDFs can be opened in Acrobat and Reader versions 5.0 and later.

PDF/X-1a (2001 and 2003) PDF/X-1a requires all fonts to be embedded, the appropriate marks and bleeds to be specified, and color to appear as CMYK, spot colors, or both. Compliant files must contain information describing the printing condition for which they are prepared. PDF files created with PDF/X-1a compliance can be opened in Acrobat 4.0 and Acrobat Reader 4.0 and later.

PDF/X-1a uses PDF 1.3, downsamples color and grayscale images to 300 ppi and monochrome images to 1200 ppi, embeds subsets of all fonts, creates untagged PDFs, and flattens transparency using the High Resolution setting.

note: The PDF/X1-a:2003 and PDF/X-3 (2003) presets are placed on your computer during installation but are not available until you move them from the Extras folder to the Settings folder.

PDF/X-3 This preset creates a PDF based on the ISO standard PDF/X-3:2002. The PDF created in this setting can be opened in Acrobat 4.0 and Acrobat Reader 4.0 or later.

PDF/X-4 (2008) This preset creating ISO PDF/X-4:2008 files supports live transparency (transparency is not flattened) and ICC color management. PDF files exported with this preset are in PDF 1.4 format for CS5 and PDF 1.6 format for CS5.5 and later. Images are downsampled and compressed and fonts are embedded in the same manner as with the PDF/X-1a and PDF/X-3 settings. You can create PDF/X-4:2008 compliant PDF files directly from Creative Suite 4 and 5 components including Illustrator, InDesign, and Photoshop. Acrobat 9 Pro provides facilities to validate and preflight PDF files for PDF/X-4:2008 compliance as well as convert non-PDF/X files to PDF/X-4:2008 if possible. Adobe recommends PDF/X-4:2008 as the optimal PDF file format for reliable PDF print publishing workflows.

Press Quality Creates PDF files for high-quality print production (for example, for digital printing or for separations to an imagesetter or platesetter), but does not create files that are PDF/X-compliant. In this case, the quality of the content is the highest consideration. The objective is to maintain all the information in a PDF file that a commercial printer or print service provider needs in order to print the document correctly. This set of options uses PDF 1.4, converts colors to CMYK, downsamples color and grayscale images to 300 ppi and monochrome images to 1200 ppi, embeds subsets of all fonts, and preserves transparency (for file types capable of transparency).

These PDF files can be opened in Acrobat 5.0 and Acrobat Reader 5.0 and later.

Note: Before creating an Adobe PDF file to send to a commercial printer or print service provider, find out what the output resolution and other settings should be, or ask for a .joboptions file with the recommended settings. You might need to customize the Adobe PDF settings for a particular provider and then provide a .joboptions file of your own.

Smallest File Size Creates PDF files for displaying on the web, an intranet, or for email distribution. This set of options uses compression, downsampling, and a relatively low image resolution. It converts all colors to sRGB and embeds fonts. It also optimizes files for byte serving. For best results, avoid using this preset if you intend to print the PDF file.

These PDF files can be opened in Acrobat 5.0 and Acrobat Reader 5.0 and later.

Magazine Ads 2006 (Japan) This preset creates a PDF based on the creation rules designed by Digital Data Delivery committee.

Standard (Acrobat only) Creates PDF files to be printed to desktop printers or digital copiers, published on a CD, or sent to a client as a publishing proof. This set of options uses compression and downsampling to keep the file size down, but also embeds subsets of all (allowed) fonts used in the file, converts all colors to sRGB, and prints to a medium resolution. Note that Windows font subsets are not embedded by default. PDF files created with this settings file can be opened in Acrobat 6.0 and Acrobat Reader 6.0 and later.

[To the top](#)

Customize Adobe PDF presets

Although the default PDF presets are based on best practices, you may discover that your workflow, or perhaps your printer's workflow, requires specialized PDF settings that aren't available via any of the built-in presets. If this is the case, you or your service provider can create custom presets. Adobe PDF presets are saved as .joboptions files.

1. Choose File > Adobe PDF Presets > Define.
2. Do one of the following:
 - To create a new preset, click New. If you want to base the new preset on an existing preset, select the preset first. Set PDF options, and click OK. (See [Adobe PDF presets](#).)
 - To edit an existing custom preset, select the preset and click Edit. (You cannot edit the default presets.) Set PDF options, and click OK.
 - To delete a preset, select it and click Delete.
 - To save a preset in a location other than the default Settings folder in the Adobe PDF folder, select it and click Save As. Specify a location and click Save.

Alternatively, you can create a custom preset when you save a PDF file by clicking Save Preset at the bottom of the Export Adobe PDF dialog box. Enter a name for the preset and click OK.

[To the top](#)

Load Adobe PDF presets

New PDF presets (.joboptions files) that you create are stored in the Settings folder in the following locations:

Windows XP Documents and Settings\[username]\Application Data\Adobe\Adobe PDF

Windows Vista and Windows 7 Users\[username]\AppData\Roaming\Adobe\Adobe PDF

Mac OS User/[username]/Library/Application Support/Adobe/Adobe PDF

These presets automatically appear in the Adobe PDF Presets menu.

Supplementary InDesign PDF presets are installed in the system's Adobe PDF\Extras folder. Use your system search utility to locate additional .joboptions files. You may also receive custom PDF presets from service providers and colleagues. For these presets to be listed in the Adobe PDF Presets menu, they must be moved to the Settings folder either manually or by using the Load command.

Load PDF presets

The Load command is useful if you want to load PDF presets that someone sent you, or to load PDF presets from InDesign CS2.

1. Choose File > Adobe PDF Presets > Define.
2. Click Load and select the .joboptions file you want to load.

The .joboptions file is copied to the Settings folder where new PDF presets are stored.

 *To make a .joboptions file available in the Adobe PDF Presets menu, you can also drag it to the Settings folder where your PDF presets are stored.*

Convert PDF presets from InDesign CS

InDesign CS and earlier export PDF presets with .pdfs extensions, while InDesign CS2 and later export PDF presets with .joboptions extensions. Importing a PDFS file converts it to a .joboptions file, and overrides settings as necessary. For example, if Monitor RGB was selected as the destination profile in the Output area in InDesign CS, it is automatically changed to Document RGB in InDesign CS4.

1. Choose File > Adobe PDF Presets > Define.
2. Click Load.
3. Choose Previous-version PDF Settings Files (.pdfs) from the Files Of Type menu (Windows) or All Files from the Enable menu (Macintosh).
4. Double-click the file you want to convert.

The file becomes selected in the list of Adobe PDF presets.

[To the top](#)

Background Tasks panel

With the ability to export PDF files in the background, you can continue working on your document instead of waiting until InDesign is done exporting. You can also queue up multiple PDF exports in the background. Use the Background Tasks panel to view the progress of the export processes.

1. Export one or more documents to Adobe PDF.
2. To view the progress, choose Window > Utilities > Background Tasks.
 - [Adobe PDF options](#)
 - [PDF compatibility levels](#)
 - [Create interactive documents for PDF](#)

 Twitter™ and Facebook posts are not covered under the terms of Creative Commons.

[Legal Notices](#) | [Online Privacy Policy](#)

Export to JPEG format

JPEG uses a standardized image compression mechanism to compress full-color or grayscale images for onscreen display. Use the Export command to export a page, spread, or selected object in JPEG format.

1. If desired, select an object to export. (You do not need to select anything to export a page or spread.)
2. Choose File > Export.
3. Specify a location and a filename.
4. For Save As Type (Windows) or Format (Mac OS), choose JPEG, and click Save.

The Export JPEG dialog box appears.

5. In the Export section, do one of the following:

Selection Export the currently selected object.

Range Enter the number of the page or pages you want to export. Separate numbers in a range by using a hyphen, and separate multiple pages or ranges by using commas.

Select All Export all pages in the documents.

Spreads Export facing pages in a spread to a single JPEG file. Deselect this option to export each page in a spread as a separate JPEG file.

6. For Quality, choose from a range of options that determine the trade-off between file compression (smaller file size) and image quality:
 - Maximum includes all available high-resolution image data in the exported file and requires the most disk space. Choose this option if the file will be printed on a high-resolution output device.
 - Low includes only screen-resolution versions (72 dpi) of placed bitmap images in the exported file. Choose this option if the file will be displayed onscreen only.
 - Medium and High include more image data than Low, but use varying levels of compression to reduce file size.
7. For Format Method, choose one of the following options:
 - Progressive displays a JPEG image in increasing detail as it is downloaded to a web browser.
 - Baseline displays a JPEG image after it has been downloaded completely.
8. Select or type the resolution for the exported JPEG image.

9. Specify the color space of the exported file. You can choose to export as RGB, CMYK, or Gray.

10. Select any of the following items, and then click Export.

Embed Color Profile When this option is selected, the document's color profile is embedded in the exported JPEG file. The name of the color profile is displayed in small text to the right of the option. You can select the desired profile for the document by choosing Edit > Assign Profiles before exporting to JPEG.

If Gray is chosen from the Color Space menu, the Embed Color Profile option is disabled.

Use Document Bleed Settings If this option is selected, the bleed area specified in Document Setup appears in the resulting JPEG. This option is disabled if the Selection option is chosen.

Anti-Alias Anti-aliasing smooths the jagged edges of text and bitmap images.

Simulate Overprint This option is similar to the Overprint Preview feature but works for any of the selected color spaces. If selected, the JPEG file that InDesign exports simulates the effects of overprinting spot inks with different neutral density values by converting spot colors to process colors for printing.

- [JPEG \(.jpg\) files](#)

 Twitter™ and Facebook posts are not covered under the terms of Creative Commons.

[Legal Notices](#) | [Online Privacy Policy](#)

Export content for EPUB | CS6

Overview

Export to EPUB

EPUB Export options

EPUB General options

EPUB Image options

EPUB Advanced options

EPUB resources

[To the top](#)

Overview

Before you export your layout to EPUB, you can make a few tweaks to ensure that it exports properly.

- **Add anchored graphics** - Anchor graphics in text flows so that you can control their position relative to the exported text. See [Anchored Objects](#).
- **Object Export Options** - Specify export options for placed objects. See [Object Export Options](#).
- **Map styles to export tags** - Map character and paragraph styles to HTML tags and classes. See [Map Styles to export tags](#).
- **Choose content and order** - Use the Articles panel to choose the content to export and order in which it should appear. See [Articles](#). You can also order content based on page layout or the XML structure.

[To the top](#)

Export to EPUB

You can export a document or book as a reflowable eBook in EPUB format that is compatible with eBook reader software.

1. Do one of the following:

- Open the document and choose File > Export.
- Open a book and from the Book panel menu, choose Export Book to EPUB.

2. Specify a filename and location.

3. From the Save as Type list choose EPUB, and then click Save.

4. In the EPUB Export Options dialog box, specify the desired options in the General, Image, and Advanced areas.

InDesign creates a single .epub file containing the XHTML-based content. If specified, the exported file may include a cover image. The cover image is created from an image, or created by rasterizing the first page in the specified document (or the style source document if a book was selected). The thumbnail is used to depict the book in the EPUB readers or the Digital Editions Reader library view. To view the file, you need an EPUB reader. You can also use the Adobe Digital Editions software, which you can download free from the Adobe website.

 *The .epub file is essentially a .zip file. To view and edit the contents of an EPUB file, change the extension from .epub to .zip, and then extract the contents. This is especially useful for editing the CSS file.*

Note: InDesign objects such as text frames and objects that contain placed images are always exported when you choose the Based on Page Layout ordering option. Empty objects are not exported unless you have applied a setting to the InDesign object via the Object Export Options to make it export as a JPEG, GIF, or PNG.

EPUB Export options

EPUB General options

The General section of the EPUB Export Options dialog box includes the following options.

Version Specify a version for the EPUB.

EPUB 2.0.1 EPUB 2.0.1 is a standard approved by IDPF in 2007. This format is supported on a wide variety of devices.

EPUB 3.0 EPUB 3.0 is a standard approved by IDPF in 2011. This format also supports audio, video, javascript, Japanese vertical text. The new features however will not work on readers and devices that do not support EPUB 3.0 standard.

EPUB 3.0 with Layout This is an experimental format created by Adobe Systems. It supports multiple-columns, text wrap, and other controls so that your layouts look good on all layouts. This feature will only work with specific viewer technologies.

Cover Specifies the cover image for the eBook. Choose one of the following:

None If this option is selected no cover image is added to the eBook.

Rasterize First Page If this option is selected creates an image file by rasterizing the first page of the eBook to use as the cover.

Choose image If this option is selected you can specify an image on your computer to use as the cover.

TOC Style Select this option if you want to generate a table of contents based on the selected TOC style. From the TOC Style menu, specify the TOC style you want to use to build the table of contents in the eBook. You can choose Layout > Table Of Contents Styles to create a special TOC style for your eBook.

Margins Specify values for the Top, Bottom, Left, and Right margins in pixels. To use the same value for each margin, click the Constrain icon.

Content Order Specify the order in which page elements are exported

Based on Page Layout The location of the items on the page determines the reading order.

If Based On Page Layout is selected, InDesign determines the reading order of page objects by scanning left to right and top to bottom. In some instances, especially in complex, multicolumn documents, the design elements may not appear in the desired reading order. Use Dreamweaver to rearrange and format the contents.

(Asian versions only) If Based On Page Layout is selected, InDesign determines the reading order of page objects according to the document's binding (left to right or right to left). In some instances, especially in complex, multicolumn documents, the exported design elements may not appear in the desired reading order. Use Dreamweaver to rearrange and format the contents.

Same as XML Structure The order of the tags in Structure View determines the reading order. See [Tag page items](#).

Same as Articles panel The order of elements in the Articles panel determines the reading order. Only the checked articles are exported. See Include articles for export.

Place Footnote After Paragraph Check to place footnotes after the paragraph. If deselected, footnotes are converted to endnotes.

Remove Forced Line Breaks Check to remove all soft-returns in the exported eBook.

Bullets Select Map To Unordered List to convert bullet paragraphs into List Items, which are formatted in HTML using the tag. Select Convert To Text to format using the <p> tag with bullet characters as text. If you have used native InDesign auto-bullets, subbullets are also included.

Numbers Determines how numbers are converted in the HTML file. If you have used native InDesign auto-numbering, subbullets are also included

Map To Ordered List Converts numbered lists into List Items, which are formatted in HTML using the tag.

Map To Static Ordered List Converts numbered lists into List Items, but assigns a <value> attribute based on the paragraph's current number in InDesign.

Convert To Text Converts numbered lists into paragraphs that begin with the paragraph's current number as text.

View EPUB After Exporting Opens the EPUB in the default application selected for reading EPUB, if present.

EPUB Image options

The Images section of the EPUB Export options dialog box includes the following options. From the Image Conversion menu, determine how images are exported to HTML.

Preserve Appearance from Layout Check to inherit the image object attributes from the layout.

Resolution (ppi) Choose the resolution of the images in pixels per inch (ppi). While operating systems have standardized on either 72 ppi or 96 ppi, mobile devices range from 132 ppi (iPad), to 172 ppi (Sony Reader), to over 300 ppi (iPhone 4). You can choose a ppi value for each object selected. Values include 72, 96, 150 (average for all eBook devices today), and 300.

Image Size Specify if image size must remain fixed or resized relative to the page. Relative to Page Size sets a relative percentage value based on the size of the image relative to the InDesign page width. This option causes the images to rescale proportionally, relative to the width of the reading area.

Image Alignment and Spacing Specify the image alignment, left, center, right, and the space before and space after.

Insert Page Break Check to insert page breaks with images. Page breaks can be inserted Before Image, After Image, or Before and After Image.

Settings Apply to Anchored Objects Check to apply these settings to all anchored objects.

Image Conversion Lets you choose whether the optimized images in your document are converted to GIF, JPEG, or PNG. Choose Automatic to let InDesign decide which format to use in each instance. Choosing PNG disables the image compression settings; use PNG for lossless images or for images that include transparency.

GIF Options (Palette) Lets you control how InDesign handles colors when optimizing GIF files. The GIF format uses a limited color palette, which cannot exceed 256 colors.

Choose Adaptive to create a palette using a representative sample of colors in the graphic without any dithering (mixing of small spots of colors to simulate additional colors). Choose Web to create a palette of web-safe colors that are a subset of Windows and Mac OS system colors. Choose System (Win) or System (Mac) to create a palette using the built-in system color palette. This choice may cause unexpected results.

Select Interlace to load the images progressively by filling in missing lines. If this option is not selected, an image looks fuzzy and gradually becomes clear as the image reaches full resolution.

JPEG Options (Image Quality) Determines the trade-off between compression (for smaller file sizes) and image quality for each JPEG image created. Low produces the smallest file and lowest image quality.

JPEG Options (Format Method) Determines how quickly JPEG graphics display when the file containing the image is opened on the web. Choose Progressive to make the JPEG images display gradually and in increasing detail as they are downloaded. (Files created with this option are slightly larger and require more RAM for viewing.) Choose Baseline to make each JPEG file display only after it has been downloaded; a placeholder appears in its place until the file is displayed.

Ignore Object Conversion Settings Ignores Object Export Options applied on individual images. See [Apply Object export options](#).

EPUB Advanced options

The Contents section of the EPUB Options dialog box includes the following options.

Split Document You can split the eBook at the specified paragraph style. Splitting results in a larger number of HTML files in the EPUB package, but can be helpful for breaking up long files and increases performance in the EPUB readers.

Include Document Metadata The metadata from the document (or the style source document if a book was selected) is included with the exported file.

Publisher Specify the publisher information that appears in the eBook metadata. You can specify a URL for the publisher so that someone who receives the eBook can visit the publisher's website.

Unique ID Every EPUB document requires a unique identifier. A unique identifier is automatically created and displayed. You can remove it and specify a unique identifier.

CSS Options Cascading Style Sheets (CSS) are a collection of formatting rules that control the appearance of content in a web page. When you use CSS to format a page, you separate content from presentation.

Include Style Definitions When exporting to EPUB, you can create a list of CSS styles that can be edited.

Preserve Local Overrides If this option is selected, local formatting such as italic or bold is included.

Include Embeddable Fonts Includes all fonts that are embeddable, in the eBook. Fonts include *embedding bits* that determine if the font is embeddable.

Add Style Sheet Specify the URL of the existing CSS style sheet, which is usually a relative URL, such as "/styles/style.css." InDesign does not check whether the CSS exists or is valid, so you'll want to confirm your CSS setup.

Add Script Specify the URL of an existing JavaScript. InDesign does not check whether the JavaScript exists or is valid, so you'll want to confirm your JavaScript setup.

[To the top](#)

EPUB resources

Use the following links to learn about EPUB format.

- For more information on the EPUB specification, see www.idpf.org.
- Download a free copy of the Digital Editions reader at www.adobe.com/products/digitaleditions.
- See the blog [Digital Editions](#) for information on Digital Editions.
- For information on exporting to Kindle, see the [InDesign to Kindle white paper](#) (PDF).
- Learn how to convert your InDesign files to the EPUB format and start selling your eBooks for viewing on the Apple iPad. See the [InDesign to iPad white paper](#).



Twitter™ and Facebook posts are not covered under the terms of Creative Commons.

[Legal Notices](#) | [Online Privacy Policy](#)

Exporting

Export text

Exporting content for the web

Export content to Dreamweaver (CS5)

Export content for EPUB (CS5)

Export content to Buzzword

Use the web color swatch library

[To the top](#)

Export text

You can save all or part of an InDesign story in file formats that you can open later in other applications. Each story in a document exports to a separate document.

InDesign can export text in several file formats, which are listed in the Export dialog box. The formats listed are used by other applications, and they may retain many of the type specifications, indents, and tabs set in your document.

You can save sections of commonly used text and page layout items as snippets.

1. Using the Type tool , click in the story you want to export.
2. Choose File > Export.
3. Specify a name and location for the exported story, and select a text file format under Save as Type (Windows) or Format (Mac OS).

If you don't see a listing for your word-processing application, you can save the document in a format the application can import, such as RTF. If your word-processing application doesn't support any other InDesign export formats, use a text-only format. Note, however, that exporting in text-only format removes all character attributes from the text.

4. Click Save to export the story in the format you've selected.

To retain all formatting, use the Adobe InDesign Tagged Text export filter. For more information, view the Tagged Text PDF at www.adobe.com/go/learn_id_taggedtext_cs5_en (PDF).

[To the top](#)

Exporting content for the web

To repurpose InDesign content for the web, you have several options:

Dreamweaver (XHTML) Export a selection or the entire document to a basic, unformatted HTML document. You can link to images on a server or create a separate folder for images. You can then use any HTML editor, such as Adobe Dreamweaver®, to format the content for the web. See [Export content to Dreamweaver \(CS5\)](#).

Copy and paste Copy text or images from the InDesign document and paste it into your HTML editor.

Adobe PDF Export a document to Adobe PDF and post the PDF on the web. The PDF can include interactive elements such as movies, sound clips, buttons, and page transitions. See Dynamic PDF documents.

Flash (SWF) Export to a SWF file that's ready to be viewed immediately in Flash Player or on the web. A SWF file can include buttons, hyperlinks, and page transitions such as wipe, dissolve, and page curl. See [Create interactive SWF \(Flash\) files for the web](#).

Flash (FLA) Export to a FLA file that can be edited in Adobe Flash Professional. See [Create FLA files for the web](#).

Digital Editions (EPUB) Export a document or book as a reflowable XHTML-based eBook that is compatible with the Adobe Digital Editions reader software. See [Export content for EPUB \(CS5\)](#).

XML For advanced repurposing workflows, export the content from InDesign in XML format, which you can then import into an HTML editor such as Dreamweaver. See [Working with XML](#).

[To the top](#)

Export content to Dreamweaver (CS5)

Exporting to XHTML is an easy way to get your InDesign contents into web-ready form. When you export contents to XHTML, you can control how text and images are exported. InDesign preserves the names of paragraph, character, object, table, and cell styles applied to the exported contents by marking the XHTML contents with CSS style classes of the same name. Using Adobe Dreamweaver or any CSS-capable HTML editor, you can quickly apply formatting and layout to the contents.

What gets exported InDesign exports all stories, linked and embedded graphics, SWF movie files, footnotes, text variables (as text), bulleted and numbered lists, internal cross-references, and hyperlinks that jump to text or web pages. Tables are also exported, but certain formatting, such as table and cell strokes, is not exported. Tables are assigned unique IDs, so they can be referenced as Spry data sets in Dreamweaver.

What doesn't get exported InDesign does not export objects you draw (such as rectangles, ovals, and polygons), movie files (except for SWF), hyperlinks (except for links to web pages and links applied to text that jump to text anchors in the same document), pasted objects (including pasted Illustrator images), text converted to outlines, XML tags, books, bookmarks, SING glyphlets, page transitions, index markers, objects on the pasteboard that aren't selected and don't touch the page, or master page items (unless they're overridden or selected before export).

1. If you're not exporting the entire document, select the text frames, range of text, table cells, or graphics you want to export.
2. Choose File > Export For > Dreamweaver.
3. Specify the name and location of the HTML document, and then click Save.
4. In the XHTML Export Options dialog box, specify the desired options in the General, Images, and Advanced areas, and then click Export.

A document with the specified name and an .html extension (such as "newsletter.html") is created; if specified, a web images subfolder (such as "newsletter-web-images") is saved in the same location.

XHTML export options

In the XHTML dialog box (File > Export For > Dreamweaver), specify the following options.

General options

The General area includes the following options.

Export Determines whether only the selected items or the entire document is exported. If a text frame is selected, the entire story—including overset text—is exported.

If Document is selected, all page items from all spreads are exported, except for master page items that have not been overridden and page items on invisible layers. XML tags and generated indexes and tables of contents are also ignored.

Bullets Select Map To Unordered List to convert bullet paragraphs into List Items, which are formatted in HTML using the tag. Select Convert To Text to format using the <p> tag with bullet characters as text.

Ordering Use either the page order or XML structure to determine the reading order of page objects.

If Base On Page Layout is selected, InDesign determines the reading order of page objects by scanning left to right and top to bottom. In some instances, especially in complex, multi-column documents, the design elements may not appear in the desired reading order. Use Dreamweaver to rearrange and format the contents.

If Base On Page Layout is selected, InDesign determines the reading order of page objects according to the document's binding (left to right or right to left). In some instances, especially in complex, multi-column documents, the exported design elements may not appear in the desired reading order. Use Dreamweaver to rearrange and format the contents.

If Same As XML Structure is selected, the XML Structure panel controls the ordering of the exported content and which content gets exported. If your content is already tagged, you can simply drag the tags in the XML Structure panel to set the XHTML Export order. If your content is not tagged, you can choose Add Untagged Items from the Structure panel menu to generate tags that you can reorder. If you do not want an item to be included in the export, you can simply delete the tag in the XML Structure panel. (Deleting a tag does not delete the content from the INDD file.) See Tag page items.

Numbers Determines how numbers are converted in the HTML file.

Map To Ordered List Converts numbered lists into List Items, which are formatted in HTML using the tag.

Map To Static Ordered List Converts numbered lists into List Items, but assigns a <value> attribute based on the paragraph's current number in InDesign.

Convert To Text Converts numbered lists into paragraphs that begin with the paragraph's current number as text.

Images options

From the Copy Images menu, determine how images are exported to HTML.

Original Exports the original image to the web images subfolder. When this option is selected, all other options are dimmed.

Optimized Lets you change settings to determine how the image is exported.

Formatted Preserves InDesign formatting, such as rotation or scale, as much as possible for web images.

Image Conversion Lets you choose whether the optimized images in your document are converted to GIF or JPEG. Choose Automatic to let InDesign decide which format to use in each instance.

GIF Options (Palette) Lets you control how InDesign handles colors when optimizing GIF files. The GIF format uses a limited color palette, which cannot exceed 256 colors.

Choose Adaptive (No Dither) to create a palette using a representative sample of colors in the graphic without any dithering (mixing of small spots of colors to simulate additional colors). Choose Web to create a palette of web-safe colors that are a subset of Windows and Mac OS system colors. Choose System (Win) or System (Mac) to create a palette using the built-in system color palette. This choice may cause unexpected results.

JPEG Options (Image Quality) Determines the trade-off between compression (for smaller file sizes) and image quality for each JPEG image created. Low produces the smallest file and lowest image quality.

JPEG Options (Format Method) Determines how quickly JPEG graphics display when the file containing the image is opened on the web. Choose Progressive to make the JPEG images display gradually and in increasing detail as they are downloaded. (Files created with this option are slightly larger and require more RAM for viewing.) Choose Baseline to make each JPEG file display only after it has been completely downloaded; a placeholder appears in its place until the file displays.

Link To Server Path Rather than exporting images to a subfolder, this option lets you enter a local URL (such as "images/") that appears in front

of the image file. In the HTML code, the link attribute displays the path and extension you specify. This option is especially effective when you're converting images to web-compatible images yourself.

Note: *InDesign does not check the path you specify for Java™ scripts, external CSS styles, or image folders, so use Dreamweaver to verify paths.*

Advanced options

Use the Advanced area to set CSS and JavaScript options.

CSS Options Cascading Style Sheets (CSS) are a collection of formatting rules that control the appearance of content in a web page. When you use CSS to format a page, you separate content from presentation. The content of your page—the HTML code—resides in the HTML file itself, while the CSS rules defining the presentation of the code reside in another file (an external style sheet) or within the HTML document (usually in the Head section). For example, you can specify different font sizes for selected text, and you can use CSS to control the format and positioning of block-level elements in a web page.

Embedded CSS When exporting to XHTML, you can create a list of CSS styles that appears in the Head section of the HTML file with declarations (attributes).

If Include Style Definitions is selected, InDesign attempts to match the attributes of the InDesign text formatting with CSS equivalents. If this option is deselected, the HTML file includes empty declarations. You can edit later these declarations in Dreamweaver.

If Preserve Local Overrides is selected, local formatting such as italic or bold is included.

No CSS Selecting this option omits the CSS section from the HTML file.

External CSS Specify the URL of the existing CSS style sheet, which is usually a relative URL, such as “/styles/style.css.” InDesign does not check whether the CSS exists or is valid, so you'll want to use Dreamweaver to confirm your external CSS setup.

JavaScript Options Select Link To External JavaScript to run a JavaScript when the HTML page is opened. Specify the URL of the JavaScript, which is usually a relative URL. InDesign does not check whether the JavaScript exists or is valid.

[To the top](#)

Export content for EPUB (CS5)

You can export a document or book as a reflowable eBook in EPUB format that is compatible with the Adobe Digital Editions reader software.

1. To export a document, open the document and choose File > Export For > EPUB.
2. Specify a filename and location, and then click Save.
3. In the Digital Editions Export Options dialog box, specify the desired options in the General, Images, and Contents areas, and then click Export.

InDesign creates a single .epub file containing the XHTML-based content. The exported file includes a JPEG thumbnail image from the first page in the specified document (or the style source document if a book was selected). This thumbnail is used to depict the book in the Digital Editions Reader library view. To view the file, you need the Digital Editions software, which you can download free from the Adobe website.

 *The .epub file is essentially a .zip file. To view and edit the contents of the .epub file, change the extension from .epub to .zip, and then extract the contents. This is especially useful for editing the CSS file.*

EPUB resources

For a list of EPUB articles and resources, see www.adobe.com/go/learn_id_epub_en.

For more information on the EPUB format, see www.idpf.org.

Download a free copy of the Digital Editions reader at www.adobe.com/products/digitaleditions.

See the blog [Digital Editions](#) for information on Digital Editions.

For information on exporting to Kindle, see the [InDesign to Kindle white paper](#).

Digital Editions General export options

The General section of the Digital Editions Export Options dialog box includes the following options.

Include Document Metadata The metadata from the document (or the style source document if a book was selected) is included with the exported file.

Add Publisher Entry Specify the publisher information that appears in the eBook metadata. You may want you to specify a URL for the publisher so that someone who receives the eBook can visit the web page and purchase the eBook.

Unique Identifier Every EPUB document requires a unique identifier. You can specify the unique identifier attribute. If you leave this field empty, a unique identifier is automatically created.

Reading Order If you select Base On Page Layout, the reading order of the page items in the EPUB is determined by their location on the page. InDesign reads from left to right and top to bottom. If you want more control over the reading order, use the XML Tags panel to tag your page items. If you select Same As XML Structure, the order of the tags in Structure View determines the reading order. See Tag page items.

Bullets Select Map To Unordered List to convert bullet paragraphs into List Items, which are formatted in HTML using the tag. Select Convert To Text to format using the <p> tag with bullet characters as text.

Numbers Determines how numbers are converted in the HTML file.

Map To Ordered List Converts numbered lists into List Items, which are formatted in HTML using the tag.

Map To Static Ordered List Converts numbered lists into List Items, but assigns a <value> attribute based on the paragraph's current number in InDesign.

Convert To Text Converts numbered lists into paragraphs that begin with the paragraph's current number as text.

View eBook After Exporting Starts the Adobe Digital Editions Reader, if present. An alert message appears if your system doesn't have a reader configured to view .epub documents.

Digital Editions Images options

The Images section of the Digital Editions Export Options dialog box includes the following options. From the Image Conversion menu, determine how images are exported to HTML.

Formatted Preserves InDesign formatting, such as rotation or scale, as much as possible for web images.

Image Conversion Lets you choose whether the optimized images in your document are converted to GIF or JPEG. Choose Automatic to let InDesign decide which format to use in each instance.

GIF Options (Palette) Lets you control how InDesign handles colors when optimizing GIF files. The GIF format uses a limited color palette, which cannot exceed 256 colors.

Choose Adaptive to create a palette using a representative sample of colors in the graphic without any dithering (mixing of small spots of colors to simulate additional colors). Choose Web to create a palette of web-safe colors that are a subset of Windows and Mac OS system colors. Choose System (Win) or System (Mac) to create a palette using the built-in system color palette. This choice may cause unexpected results.

Select Interlace to display a slowly loaded image gradually by filling in missing lines. If this option is not select, an image looks fuzzy and gradually becomes clear as the image reaches full resolution.

JPEG Options (Image Quality) Determines the trade-off between compression (for smaller file sizes) and image quality for each JPEG image created. Low produces the smallest file and lowest image quality.

JPEG Options (Format Method) Determines how quickly JPEG graphics display when the file containing the image is opened on the web. Choose Progressive to make the JPEG images display gradually and in increasing detail as they are downloaded. (Files created with this option are slightly larger and require more RAM for viewing.) Choose Baseline to make each JPEG file display only after it has been completely downloaded; a placeholder appears in its place until the file displays.

Digital Editions Contents options

The Contents section of the Digital Editions Export Options dialog box includes the following options.

Format For EPUB Content Specify whether you want to use the XHTML or DTBook format.

Include InDesign TOC Entries Select this option if you want to generate a table of contents on the left side of the eBook. From the TOC Style menu, specify the TOC style you want to use in the eBook. You can choose Layout > Table Of Contents Styles to create a special TOC style for your eBook.

Suppress Automatic Entries For Documents Select this option if you don't want the document names to appear in the eBook table of contents. This option is especially useful when you're creating an eBook from a book.

Use First Level Entries As Chapter Breaks Select this options to split the ebook into multiple files, with each file beginning with the first level TOC entry. If a content file exceeds 260kb, a new chapter begins at the start of a paragraph between first level entries to help avoid the 300kb limit.

Generate CSS Cascading Style Sheets (CSS) are a collection of formatting rules that control the appearance of content in a web page. When you use CSS to format a page, you separate content from presentation.

Include Style Definitions When exporting to EPUB, you can create a list of CSS styles that can be edited.

Preserve Local Overrides If this option is selected, local formatting such as italic or bold is included.

Include Embeddable Fonts Includes in the eBook all fonts that are allowed to be embedded. Fonts include *embedding bits* that determine whether the font is allowed to be embedded.

Style Names Only Selecting this option includes only undefined style names in the EPUB stylesheet.

Use Existing CSS File Specify the URL of the existing CSS style sheet, which is usually a relative URL, such as “/styles/style.css.” InDesign does not check whether the CSS exists or is valid, so you'll want to confirm your CSS setup.

[To the top](#)

Export content to Buzzword

Buzzword is a web-based text editor that lets users create and store text files on a web server. When you export a story to Buzzword, you create a text file on the Buzzword server.

1. Select text or place the insertion point in a text frame that is part of the story you want to export.

2. Do one of the following:

- In InDesign choose File > Export For > Buzzword.
- In InCopy choose File > Export to Buzzword.

3. If you haven't already signed in to CS Live, click Sign In, specify your e-mail address and password, and then click Sign In.

4. In the Export Story For Buzzword dialog box, specify the name of the Buzzword document to be created and then click OK.

The Buzzword document is opened on Acrobat.com. You can then move the document to a different workspace and share it with other people.

[To the top](#)

Use the web color swatch library

InDesign includes a color swatch library called *Web*, which consists of the colors most web browsers use to display text and graphics in web pages. The 216 colors in the library, often called *web-safe* colors, are consistent across platforms, because they are a subset of the colors that browsers use in both Windows and Mac OS. The web-safe colors in InDesign are the same as those in the Adobe Photoshop web-safe color palette and the Adobe Illustrator browser-safe color palette.

Each color in the library is named by its RGB values. Each color's hexadecimal code, which HTML uses to define the color, is stored within the color swatch.

1. Choose New Color Swatch in the Swatches panel menu.
2. For Color Mode, choose Web.
3. Select the web-safe color, and then click OK.

Adobe also recommends

- Export to PDF for printing
- Adding content to pages
- Creating pages with CSS

 Twitter™ and Facebook posts are not covered under the terms of Creative Commons.

[Legal Notices](#) | [Online Privacy Policy](#)

Exporting XML

[Export document content to XML](#)
[Optimized image export options](#)
[Save tags only as XML](#)
[Edit an exported XML file](#)

[To the top](#)

Export document content to XML

Before you export content from an InDesign document to XML, you must have done the following:

- Created or loaded element tags.
- Applied tags to items on the pages of your document.
- Adjusted the hierarchy of tagged elements in the Structure pane, if needed.

You can export all or a portion of the XML content in your document. Only content that is tagged can be exported.

Note: *If you are exporting a document that contains tables, you must tag the tables or InDesign will not export them as part of the XML.*

1. If you want to export only a portion of the document, select the element in the Structure pane where you want exporting to begin.
2. Choose File > Export.
3. For Save As Type (Windows) or Format (Mac OS), choose XML.
4. Specify a name and location for the XML file, and then click Save.
5. In the General tab of the Export XML dialog box, choose any of the following:

Include DTD Declaration Exports the reference to the DTD along with the XML file. This option is only available if there is a DOCTYPE element in the Structure pane.

View XML Using Opens the exported file in a browser, XML editing application, or text editor. Choose the browser or application from the list.

Export From Selected Element Starts exporting from the element you selected in the Structure pane. This option is only available if you selected an element before choosing File > Export.

Export Untagged Tables As CALS XML Exports untagged tables in CALS XML format. To be exported, the table must be in a tagged frame, and the table must not be tagged.

Remap Break, Whitespace, And Special Characters Exports break, whitespace, and special characters as decimal character entities rather than straight characters.

Apply XSLT Applies a stylesheet to define the transformation of the exported XML to, for example, a modified XML tree or HTML. Select Browse (Windows) or Choose (Mac OS) to select an XSLT from the file system. The default setting, Use Stylesheet From XML, uses an XSLT transformation instruction if one is referenced in the XML that is applied on export.

6. Choose an encoding type from the Encoding menu.
7. To specify export options for images, click the Images tab, and then select one or more of the following:

Original Images Places a copy of the original image files in an Images subfolder.

Optimized Original Images Optimizes and compresses the original image files and places copies of the files in an Images sub-folder.

Optimized Formatted Images Optimizes the original image files that contain applied transformation (such as rotation or scaling) and places them in an Images sub-folder. For example, if the document contains two images, one cropped and one not, only the cropped image is optimized and copied to the Images sub-folder.

8. If you selected Optimized Original Images or Optimized Formatted Images in the previous step, choose options for the optimizing the images.
9. Click Export.

Note: Not all special characters are supported in XML (such as the Automatic Page Number character). InDesign warns you if it cannot include a character in the exported XML file. This warning also appears if you didn't tag a table.

[To the top](#)

Optimized image export options

The following options are available when you choose Optimized Original Images or Optimized Formatted Images in the Images tab of the Export XML dialog box.

Image Conversion Specifies which file format to use for the converted image. If you choose Automatic, InDesign chooses the best file type based on the image. Hence, you may want to specify both GIF Options and JPEG Options.

GIF Options Specify the formatting for images that are converted to GIF format when exported to XML. You can set the following options:

Palette Specifies the color palette you want the image to conform to when converted. Choose the palette for the final display format of the XML content. Adaptive (no dither) works well for images with primarily solid colors and can be used when the final output will be to multiple formats.

Interlace Downloads every other line of the image with each pass, instead of downloading the entire image in one pass. Interlacing enables a preview of the image to download quickly, as each successive pass adds resolution until the final quality is met.

JPEG Options Specify the formatting for images that are converted to JPEG format when exported to XML. You can set the following options:

Image Quality Specifies the quality of the converted image. The higher the quality setting, the larger the file size and the longer it takes to download.

Format Method Specifies how the JPEG image is formatted for download. Baseline downloads the final quality image in one pass, so that the file displays at its final quality as soon as it opens; this format may take longer to download than a Progressive formatted image. Progressive downloads the image in a series of passes, with the first pass a low-resolution version and each successive pass adding resolution to the image until the final quality is attained.

Save tags only as XML

Save tags only so you can load the tags into an InDesign document and make use of them there.

1. Choose Save Tags from the Tags panel menu.
2. Type a name, specify a location, and then click Save.

The tags in your document, along with their assigned colors, are saved in an XML file.

Edit an exported XML file

After you've used InDesign to create and export an XML file, you can make changes to the XML using either of these methods:

- To make changes directly in the XML file, open it in a text or XML editor.
- To make changes that will be preserved in the source document, open the InDesign file that the XML was exported from. After you make changes to the content in InDesign, you can export it to XML again, using the original XML filename if you want to replace the file.

Adobe also recommends



Twitter™ and Facebook posts are not covered under the terms of Creative Commons.

[Legal Notices](#) | [Online Privacy Policy](#)

Export content to HTML | CS6 & CS5.5

Exporting to HTML is an easy way to get your InDesign content into web-ready form. When you export content to HTML, you can control how text and images are exported. InDesign preserves the names of paragraph, character, object, table, and cell styles applied to the exported contents by marking the HTML contents with CSS style classes of the same name. Using Adobe Dreamweaver or any CSS-capable HTML editor, you can quickly apply formatting and layout to the contents.

What gets exported InDesign exports all stories, linked and embedded graphics, SWF movie files, footnotes, text variables (as text), bulleted and numbered lists, internal cross-references, and hyperlinks that jump to text or web pages. Tables are also exported, but certain formatting, such as table and cell strokes, is not exported. Tables are assigned unique IDs, so they can be referenced as Spry data sets in Dreamweaver. Placed audio and h.264 video files are enclosed in HTML5 <audio> and <video> tags.

What doesn't get exported InDesign does not export objects you draw (such as rectangles, ovals, and polygons), hyperlinks (except for links to web pages and links applied to text that jump to text anchors in the same document), pasted objects (including pasted Illustrator images), text converted to outlines, XML tags, books, bookmarks, SING glyphlets, page transitions, index markers, objects on the pasteboard that aren't selected and don't touch the page, or master page items (unless they're overridden or selected before export).

1. If you're not exporting the entire document, select the text frames, range of text, table cells, or graphics you want to export.
2. Choose File > Export and select HTML from the Save As Type list.
3. Specify the name and location of the HTML document, and then click Save.
4. In the HTML Export Options dialog box, specify the desired options in the General, Image, and Advanced areas, and then click OK.

A document with the specified name and an .html extension (such as "newsletter.html") is created; if specified, a web images subfolder (such as "newsletter-web-images") is saved in the same location.

HTML export options

In the HTML dialog box, specify the following options.

General options

The General area includes the following options.

Export Determines whether only the selected items or the entire document is exported. If a text frame is selected, the entire story—including overset text—is exported.

If Document is selected, all page items from all spreads are exported, except for master page items that have not been overridden and page items on invisible layers. XML tags and generated indexes and tables of contents are also ignored.

Content Order / Ordering lets you specify the reading order of page objects.

Based On Page Layout

The location of the items on the page determines the reading order.

If Based On Page Layout is selected, InDesign determines the reading order of page objects by scanning left to right and top to bottom. In some instances, especially in complex, multi-column documents, the design elements may not appear in the desired reading order. Use Dreamweaver to rearrange and format the contents.

(Asian versions only) If Base On Page Layout is selected, InDesign determines the reading order of page objects according to the

document's binding (left to right or right to left). In some instances, especially in complex, multi-column documents, the exported design elements may not appear in the desired reading order. Use Dreamweaver to rearrange and format the contents.

Same As XML Structure

If Same As XML Structure is selected, the XML Structure panel controls the ordering of the exported content and which content gets exported. If your content is already tagged, you can simply drag the tags in the XML Structure panel to set the XHTML Export order. If your content is not tagged, you can choose Add Untagged Items from the Structure panel menu to generate tags that you can reorder. If you do not want an item to be included in the export, you can simply delete the tag in the XML Structure panel. (Deleting a tag does not delete the content from the INDD file.) See [Tag page items](#).

Same As Articles Panel

The order of elements in the Articles panel determines the reading order. Only the checked articles are exported. See [Include articles for export](#).

Margin Specify a simple margin in Ems or pixels. Specifying margins in Ems is better for multiscreen compatibility. The same value is applied to all margins: top, bottom, left, and right.

Bullets Select Map To Unordered List to convert bullet paragraphs into List Items, which are formatted in HTML using the tag. Select Convert To Text to format using the <p> tag with bullet characters as text. If you have used native InDesign auto-bullets, sub-bullets are also included.

Numbers Determines how numbers are converted in the HTML file. If you have used native InDesign auto-numbering, sub-bullets are also included

Map To Ordered List Converts numbered lists into List Items, which are formatted in HTML using the tag.

Map To Static Ordered List Converts numbered lists into List Items, but assigns a <value> attribute based on the paragraph's current number in InDesign.

Convert To Text Converts numbered lists into paragraphs that begin with the paragraph's current number as text.

View HTML After Exporting Starts the browser, if present.

Image options

Copy Images Specify how images are exported to HTML.

Original Exports the original image to the "<document_name>-web-images" subfolder. When this option is selected, all other options are dimmed.

Optimized Lets you change settings to determine how the image is exported.

Link To Server Path Rather than exporting images to a subfolder, this option lets you enter a local URL (such as "images/") that appears in front of the image file. In the HTML code, the link attribute displays the path and extension you specify. This option is especially effective when you're converting images to web-compatible images yourself.

Preserve Appearance from Layout Check to inherit the image object attributes from the layout.

Resolution (ppi) Specify the resolution of the images in pixels per inch (ppi). While operating systems have standardized on either 72 ppi or 96 ppi, mobile devices range from 132 ppi (iPad), to 172 ppi (Sony Reader), to over 300 ppi (iPhone 4). You can specify a ppi value for each object selected. Values include 72, 96, 150 (average for all ebook devices today), and 300.

Image Size Specify if image size must remain fixed or resized relative to the page. Relative to Page Size sets a relative percentage value based on the size of the image relative to the InDesign page width. This option causes the images to rescale proportionally, relative to the width of the reading area.

Image Alignment and Spacing Specify the image alignment, left, center, right, and the space before and space after.

Settings Apply to Anchored Objects Check to apply these settings to all anchored objects.

Image Conversion Lets you choose whether the optimized images in your document are converted to GIF, JPEG, or PNG. Choose Automatic to let InDesign decide which format to use in each instance. Choosing PNG disables the image compression settings.; use PNG for lossless images or for images that include transparency.

GIF Options (Palette) Lets you control how InDesign handles colors when optimizing GIF files. The GIF format uses a limited color palette, which cannot exceed 256 colors.

Choose Adaptive to create a palette using a representative sample of colors in the graphic without any dithering (mixing of small spots of colors to simulate additional colors). Choose Web to create a palette of web-safe colors that are a subset of Windows and Mac OS system colors. Choose System (Win) or System (Mac) to create a palette using the built-in system color palette. This choice may cause unexpected results.

Select Interlace to load the images progressively by filling in missing lines. If this option is not selected, an image looks fuzzy and gradually becomes clear as the image reaches full resolution.

JPEG Options (Image Quality) Determines the trade-off between compression (for smaller file sizes) and image quality for each JPEG image created. Low produces the smallest file and lowest image quality.

JPEG Options (Format Method) Determines how quickly JPEG graphics display when the file containing the image is opened on the web. Choose Progressive to make the JPEG images display gradually and in increasing detail as they are downloaded. (Files created with this option are slightly larger and require more RAM for viewing.) Choose Baseline to make each JPEG file display only after it has been completely downloaded; a placeholder appears in its place until the file displays.

Ignore Object Conversion Settings Ignores Object Export Options applied on individual images. See [Apply Object export options](#).

Advanced options

Use the Advanced area to set CSS and JavaScript options.

CSS Options Cascading Style Sheets (CSS) are a collection of formatting rules that control the appearance of content in a web page. When you use CSS to format a page, you separate content from presentation. The content of your page—the HTML code—resides in the HTML file itself, while the CSS rules defining the presentation of the code reside in another file (an external style sheet) or within the HTML document (usually in the Head section). For example, you can specify different font sizes for selected text, and you can use CSS to control the format and positioning of block-level elements in a web page.

Embedded CSS When exporting to XHTML, you can create a list of CSS styles that appears in the Head section of the HTML file with declarations (attributes).

If Include Style Definitions is selected, InDesign attempts to match the attributes of the InDesign text formatting with CSS equivalents. If this option is deselected, the HTML file includes empty declarations. You can edit later these declarations in Dreamweaver.

If Preserve Local Overrides is selected, local formatting such as italic or bold is included.

No CSS Selecting this option omits the CSS section from the HTML file.

External CSS (CS5.5) Specify the URL of the existing CSS style sheet, which is usually a relative URL, such as “/styles/style.css.” InDesign does not check whether the CSS exists or is valid, so you’ll want to use Dreamweaver to confirm your external CSS setup.

Additional CSS (CS6) Specify CSS using the Add Style Sheet button.

JavaScript Options Select Link To External JavaScript to run a JavaScript when the HTML page is opened. Specify the URL of the JavaScript, which is usually a relative URL. InDesign does not check whether the JavaScript exists or is valid.

Export content for EPUB | CS5.5

EPUB resources

EPUB General export options

EPUB Images options

EPUB Contents options

You can export a document or book as a reflowable eBook in EPUB format that is compatible with the Adobe Digital Editions reader software, and other eBook reader software.

1. Do one of the following:

- Open the document and choose File > Export.
- Open a book and from the Book panel menu, choose Export Book to EPUB.

2. Specify a filename and location.

3. From the Save as Type list choose EPUB, and then click Save.

4. In the EPUB Export Options dialog box, specify the desired options in the General, Image, and Contents areas.

InDesign creates a single .epub file containing the XHTML-based content. If specified, the exported file may include a cover image. The cover image is created from an image, or created by rasterizing the first page in the specified document (or the style source document if a book was selected). The thumbnail is used to depict the book in the EPUB readers or the Digital Editions Reader library view. To view the file, you need an EPUB reader. You can also use the Adobe Digital Editions software, which you can download free from the Adobe website.

 *The .epub file is essentially a .zip file. To view and edit the contents of an .EPUB file, change the extension from .epub to .zip, and then extract the contents. This is especially useful for editing the CSS file.*

Note: InDesign objects such as text frames and objects that contain placed images, are always exported when you choose the Based on Page Layout ordering option. Empty objects are not exported unless you have applied a setting to the InDesign object via the Object Export Options to make it export as a JPEG, GIF, or PNG.

[To the top](#)

EPUB resources

Use the following links to learn about EPUB format.

- For more information on the EPUB format, see www.idpf.org.
- Download a free copy of the Digital Editions reader at www.adobe.com/products/digitaleditions.
- See the blog [Digital Editions](#) for information on Digital Editions.
- For information on exporting to Kindle, see the [InDesign to Kindle white paper](#).
- Learn how to convert your InDesign files to the EPUB format and start selling your eBooks for viewing on the Apple iPad. See the [InDesign to iPad white paper](#).

[To the top](#)

EPUB General export options

The General section of the EPUB Export Options dialog box includes the following options.

Include Document Metadata The metadata from the document (or the style source document if a book was selected) is included with the exported file.

Add Publisher Entry Specify the publisher information that appears in the eBook metadata. You can specify a URL for the publisher so that someone who receives the eBook can visit the publisher's website.

Unique Identifier Every EPUB document requires a unique identifier. You can specify the unique identifier attribute. If you leave this field empty, a unique identifier is automatically created.

EPUB Cover Specifies the cover image for the eBook. Choose one of the following:

No Cover Image If this option is selected no cover image is added to the eBook.

Rasterize First Page If this option is selected creates an image file by rasterizing the first page of the eBook to use as the cover.

Use Existing Image File If this option is selected you can specify an image on your computer to use as the cover.

Ordering lets you specify the order in which the page elements are exported.

Base On Page Layout

The location of the items on the page determines the reading order.

If Base On Page Layout is selected, InDesign determines the reading order of page objects by scanning left to right and top to bottom. In some instances, especially in complex, multicolumn documents, the design elements may not appear in the desired reading order. Use Dreamweaver to rearrange and format the contents.

(Asian versions only) If Base On Page Layout is selected, InDesign determines the reading order of page objects according to the document's binding (left to right or right to left). In some instances, especially in complex, multicolumn documents, the exported design elements may not appear in the desired reading order. Use Dreamweaver to rearrange and format the contents.

Same As XML Structure

The order of the tags in Structure View determines the reading order. See [Tag page items](#).

Same As Articles Panel

The order of elements in the Articles panel determines the reading order. Only the checked articles are exported. See [Include articles for export](#).

Book Margin Specify a simple margin in Ems or pixels. Specifying margins in Ems is better for multiscreen compatibility. The same value is applied to all margins: top, bottom, left, and right.

Bullets Select Map To Unordered List to convert bullet paragraphs into List Items, which are formatted in HTML using the tag. Select Convert To Text to format using the <p> tag with bullet characters as text. If you have used native InDesign auto-bullets, subbullets are also included.

Numbers Determines how numbers are converted in the HTML file. If you have used native InDesign auto-numbering, subbullets are also included

Map To Ordered List Converts numbered lists into List Items, which are formatted in HTML using the tag.

Map To Static Ordered List Converts numbered lists into List Items, but assigns a <value> attribute based on the paragraph's current number in InDesign.

Convert To Text Converts numbered lists into paragraphs that begin with the paragraph's current number as text.

View EPUB After Exporting Starts the Adobe Digital Editions Reader, if present.

EPUB Images options

The Images section of the Digital Editions Export Options dialog box includes the following options. From the Image Conversion menu, determine how images are exported to HTML.

Preserve Appearance from Layout Check to inherit the image object attributes from the layout.

Resolution (ppi) Specify the resolution of the images in pixels per inch (ppi). While operating systems have standardized on either 72 ppi or 96 ppi, mobile devices range from 132 ppi (iPad), to 172 ppi (Sony Reader), to over 300 ppi (iPhone 4). You can specify a ppi value for each object selected. Values include 72, 96, 150 (average for all eBook devices today), and 300.

Image Size Specify if image size must remain fixed or resized relative to the page. Relative to Page Size sets a relative percentage value based on the size of the image relative to the InDesign page width. This option causes the images to rescale proportionally, relative to the width of the reading area.

Image Alignment and Spacing Specify the image alignment, left, center, right, and the top and bottom padding.

Insert Page Break Check to insert page breaks with images. Page breaks can be inserted Before Image, After Image, or Before and After Image.

Settings Apply to Anchored Objects Check to apply these settings to all anchored objects.

Image Conversion Lets you choose whether the optimized images in your document are converted to GIF, JPEG, or PNG. Choose Automatic to let InDesign decide which format to use in each instance. Choosing PNG disables the image compression settings.; use PNG for lossless images or for images that include transparency.

GIF Options (Palette) Lets you control how InDesign handles colors when optimizing GIF files. The GIF format uses a limited color palette, which cannot exceed 256 colors.

Choose Adaptive to create a palette using a representative sample of colors in the graphic without any dithering (mixing of small spots of colors to simulate additional colors). Choose Web to create a palette of web-safe colors that are a subset of Windows and Mac OS system colors. Choose System (Win) or System (Mac) to create a palette using the built-in system color palette. This choice may cause unexpected results.

Select Interlace to load the images progressively by filling in missing lines. If this option is not selected, an image looks fuzzy and gradually becomes clear as the image reaches full resolution.

JPEG Options (Image Quality) Determines the trade-off between compression (for smaller file sizes) and image quality for each JPEG image created. Low produces the smallest file and lowest image quality.

JPEG Options (Format Method) Determines how quickly JPEG graphics display when the file containing the image is opened on the web. Choose Progressive to make the JPEG images display gradually and in increasing detail as they are downloaded. (Files created with this option are slightly larger and require more RAM for viewing.) Choose Baseline to make each JPEG file displays only after it has been downloaded; a placeholder appears in its place until the file displays.

Ignore Object Conversion Settings Ignores Object Export Options applied on individual images. See [Apply Object export options](#).

EPUB Contents options

The Contents section of the EPUB Options dialog box includes the following options.

Format For EPUB Content Specify whether you want to use the XHTML or DTBook format. DTBook is a specialized format that is intended for sight impaired end readers.

Use InDesign TOC Style Select this option if you want to generate a table of contents based on the selected TOC style. From the TOC Style menu, specify the TOC style you want to use to build the table of contents in the eBook. You can choose Layout > Table Of Contents Styles to create a special TOC style for your eBook.

Break Document at Paragraph Style You can split the eBook at the specified paragraph style. Splitting results in a larger number of HTML files in the EPUB package, but can be helpful for breaking up long files and increases performance in the EPUB readers.

Place Footnote After Paragraph Check to place footnotes after the paragraph. If deselected, footnotes are converted to endnotes.

Remove Forced Line Breaks Check to remove all soft-returns in the exported eBook.

Generate CSS Cascading Style Sheets (CSS) are a collection of formatting rules that control the appearance of content in a web page. When you use CSS to format a page, you separate content from presentation.

Include Style Definitions When exporting to EPUB, you can create a list of CSS styles that can be edited.

Preserve Local Overrides If this option is selected, local formatting such as italic or bold is included.

Include Embeddable Fonts Includes all fonts that are embeddable, in the eBook. Fonts include *embedding bits* that determine if the font is embeddable.

Style Names Only Includes only undefined style names in the EPUB style sheet.

Use Existing CSS File Specify the URL of the existing CSS style sheet, which is usually a relative URL, such as “/styles/style.css.” InDesign does not check whether the CSS exists or is valid, so you’ll want to confirm your CSS setup.

 Twitter™ and Facebook posts are not covered under the terms of Creative Commons.

[Legal Notices](#) | [Online Privacy Policy](#)

Adobe PDF options

[Adobe PDF option categories](#)
[About PDF/X standards](#)
[PDF compatibility levels](#)
[General options for PDFs](#)
[Compression and downsampling options for PDFs](#)
[Marks and Bleeds options for PDFs](#)
[Color management and PDF/X output options for PDFs](#)
[Font, OPI, and flattening options for PDFs](#)
[Adding security to PDF files](#)
[Security options for PDFs](#)
[Font embedding and substitution](#)
[Preparing a document for on-screen viewing](#)

[To the top](#)

Adobe PDF option categories

You can set PDF options when you export to PDF or when you create or edit PDF presets. Adobe PDF options are divided into categories. The categories are listed on the left side of the Export Adobe PDF dialog box, with the exception of the Standard and Compatibility options, which are at the top of the dialog box. When you're exporting to PDF, changing any of the options causes "modified" to appear at the end of the preset name.

Standard Specifies a PDF/X format for the file.

Compatibility Specifies a PDF version for the file.

General Specifies basic file options.

Compression Specifies if artwork should be compressed and downsampled, and if so, which method and settings to use.

Marks and Bleeds Specifies printer's marks and the bleed and slug areas. Although the options are the same as in the Print dialog box, the calculations are subtly different because a PDF is not output to a known page size.

Output Controls how colors and PDF/X output intent profiles are saved in the PDF file.

Advanced Controls how fonts, OPI specifications, transparency flattening, and JDF instructions are saved in the PDF file.

Security Adds security to the PDF file. Security options are not available when you create or edit a PDF preset.

Summary Displays a summary of the current PDF settings. You can click the arrow next to a category (for example, General) to view individual settings. To save the summary as an ASCII text file, click Save Summary. A warning icon  appears with explanatory text if a setting in the selected preset cannot be honored and must be remapped. For example, if a preset specifies source profiles that don't match the current color settings file, then the profiles specified by the color settings file will be used.

[To the top](#)

About PDF/X standards

PDF/X standards are defined by the International Organization for Standardization (ISO). PDF/X standards apply to graphic content exchange.

During PDF conversion, the file that is being processed is checked against the specified standard. If the PDF will not meet the selected ISO standard, a message appears, asking you to choose between canceling the conversion or going ahead with the creation of a non-compliant file. A widely used standards for a print publishing workflow is the PDF/X format such as PDF/X-1a.

The PDF/X-4 format is reliable for live transparency and color management. This format is optimal for RIP processing, digital printers that use the Adobe PDF Print Engine, and any PDF file to be printed in Acrobat.

Note: For more information on PDF/X, see the [ISO website](#) and the [Adobe website](#).

[To the top](#)

PDF compatibility levels

When you create PDFs, you need to decide which PDF version to use. You can change the PDF version by switching to a different preset or choosing a compatibility option when you save as PDF or edit a PDF preset.

Generally speaking, unless there's a specific need for backward compatibility, you should use the most recent version (in this case version 1.7). The latest version will include all the newest features and functionality. However, if you're creating documents that will be distributed widely, consider choosing Acrobat 5.0 (PDF 1.4) or Acrobat 6.0 (PDF 1.5) to ensure that all users can view and print the document.

The following table compares some of the functionality in PDFs created using the different compatibility settings.

Note: Acrobat 8.0 and 9.0 also use PDF 1.7.

Acrobat 3.0 (PDF 1.3)	Acrobat 5.0 (PDF 1.4)	Acrobat 6.0 (PDF 1.5)	Acrobat 7.0 (PDF 1.6) and Acrobat X (PDF 1.7)
PDFs can be opened with Acrobat 3.0 and Acrobat Reader 3.0 and later.	PDFs can be opened with Acrobat 3.0 and Acrobat Reader 3.0 and later. However, features specific to later versions may be lost or not viewable.	Most PDFs can be opened with Acrobat 4.0 and Acrobat Reader 4.0 and later. However, features specific to later versions may be lost or not viewable.	Most PDFs can be opened with Acrobat 4.0 and Acrobat Reader 4.0 and later. However, features specific to later versions may be lost or not viewable.
Cannot contain artwork that uses live transparency effects. Any transparency must be flattened prior to converting to PDF 1.3.	Supports the use of live transparency in artwork. (The Acrobat Distiller feature flattens transparency.)	Supports the use of live transparency in artwork. (The Acrobat Distiller feature flattens transparency.)	Supports the use of live transparency in artwork. (The Acrobat Distiller feature flattens transparency.)
Layers are not supported.	Layers are not supported.	Preserves layers when creating PDFs from applications that support the generation of layered PDF documents, such as Illustrator CS and later or InDesign CS and later.	Preserves layers when creating PDFs from applications that support the generation of layered PDF documents, such as Illustrator CS and later or InDesign CS and later.
DeviceN color space with 8 colorants is supported.	DeviceN color space with 8 colorants is supported.	DeviceN color space with up to 31 colorants is supported.	DeviceN color space with up to 31 colorants is supported.
Multibyte fonts can be embedded. (Distiller converts the fonts when embedding.)	Multibyte fonts can be embedded.	Multibyte fonts can be embedded.	Multibyte fonts can be embedded.
40-bit RC4 security supported.	128-bit RC4 security supported.	128-bit RC4 security supported.	128-bit RC4 and 128-bit AES (Advanced Encryption Standard) security supported.

General options for PDFs

Click the General category in the Export Adobe PDF dialog box to set the following options:

Description Displays the description from the selected preset, and provides a place for you to edit the description. You can paste a description from the Clipboard.

All Exports all pages in the current document or book.

Range Specifies the range of pages to export in the current document. You can type a range by using a hyphen, and separate multiple pages or ranges by using commas. This option is unavailable when you're exporting books or creating presets.

Spreads Exports pages together as if they were printed on the same sheet.

Note: Do not select Spreads for commercial printing; if you do, the service provider cannot impose the pages.

Embed Page Thumbnails Embeds a thumbnail preview for each page in the PDF, increasing the file size. Deselect this setting when users of Acrobat 5.0 and later will view and print the PDF; these versions generate thumbnails dynamically each time you click the Pages panel of a PDF.

Optimize For Fast Web View Reduces PDF file size, and optimizes the PDF file for faster viewing in a web browser by restructuring the file for page-at-a-time downloading (byte serving). This option compresses text and line art, regardless of the settings you have selected in the Compression category of the Export Adobe PDF dialog box.

Create Tagged PDF During export, automatically tags elements in the story based on a subset of the Acrobat tags that InDesign supports. This includes recognition of paragraphs, basic text formatting, lists, and tables. (You can also insert and adjust tags in the document before exporting to PDF. See Adding structure to PDFs.)

Note: If Compatibility is set to Acrobat 6 (PDF 1.5) or later, tags are compressed for smaller file size. If the PDF is then opened in Acrobat 4.0 or Acrobat 5.0, the tags will not be visible because those versions of Acrobat cannot decompress tags.

View PDF After Exporting Opens the newly-created PDF file in the default PDF viewing application.

Create Acrobat Layers Saves each InDesign layer as an Acrobat layer within the PDF. Also exports any printer's marks you've included to a separate marks and bleeds layer. The layers are fully navigable, which allows users of Acrobat 6.0 and later to generate multiple versions of the file from a single PDF. For example, if a document will be published in multiple languages, you can place the text for each language in a different layer. A prepress service provider can then show and hide the layers to generate different versions of the document.

If you select the Create Acrobat Layers option when you export a book to PDF, identically named layers are merged by default.

Note: Create Acrobat Layers is available only when Compatibility is set to Acrobat 6 (PDF 1.5) or later.

Export Layers Determines whether visible layers and nonprinting layers are included in the PDF. You can use the Layer Options settings to determine whether each layer is hidden or set as nonprinting. When exporting to PDF, choose whether you want to export All Layers (including hidden and nonprinting layers), Visible Layers (including nonprinting layers), or Visible & Printable Layers.

Bookmarks Creates bookmarks for table of contents entries, preserving the TOC levels. Bookmarks are created from the information specified in the Bookmarks panel.

Hyperlinks Creates PDF hyperlink annotations for InDesign hyperlinks, table of contents entries, and index entries.

Visible Guides And Grids Exports margin guides, ruler guides, column guides, and baseline grids currently visible in the document. Grids and guides export in the same color used in the document.

Non-Printing Objects Exports objects to which you have applied the Nonprinting option in the Attributes panel.

Interactive Elements Choose Include Appearance to include items such as buttons and movie posters in the PDF. To create a PDF with interactive elements, choose the Adobe PDF (Interactive) option instead of the Adobe PDF (Print) option. See Export to interactive PDF options.

[To the top](#)

Compression and downsampling options for PDFs

When exporting documents to Adobe PDF, you can compress text and line art, and compress and downsample bitmap images. Depending on the settings you choose, compression and downsampling can significantly reduce the size of a PDF file with little or no loss of detail and precision.

The Compression area of the Export Adobe PDF dialog box is divided into three sections. Each section provides the following options for compressing and resampling color, grayscale, or monochrome images in your artwork.

Downsampling If you plan to use the PDF file on the web, use downsampling to allow for higher compression. If you plan to print the PDF file at high resolution, check with your prepress service provider before setting compression and downsampling options.

You should also consider whether users need to magnify a page. For example, if you are creating a PDF document of a map, consider using a higher image resolution so that users can zoom in on the map.

Downsampling refers to decreasing the number of pixels in an image. To downsample color, grayscale, or monochrome images, choose an interpolation method—average downsampling, bicubic downsampling, or subsampling—and enter the desired resolution (in pixels per inch). Then enter a resolution in the For Images Above text box. All images with resolution above this threshold will be downsampled.

The interpolation method you choose determines how pixels are deleted:

Average Downsampling To

Averages the pixels in a sample area and replaces the entire area with the average pixel color at the specified resolution.

Subsampling To

Chooses a pixel in the center of the sample area and replaces the entire area with that pixel color. Subsampling significantly reduces the conversion time compared with downsampling but results in images that are less smooth and continuous.

Bicubic Downsampling To

Uses a weighted average to determine pixel color, which usually yields better results than the simple averaging method of downsampling. Bicubic is the slowest but most precise method, resulting in the smoothest tonal gradations.

Compression Determines the type of compression that is used:

Automatic (JPEG)

Determines automatically the best quality for color and grayscale images. For most files, this option produces satisfactory results.

JPEG

Is suitable for grayscale or color images. JPEG compression is *lossy*, which means that it removes image data and may reduce image quality; however, it attempts to reduce file size with a minimal loss of information. Because JPEG compression eliminates data, it can achieve much smaller files sizes than ZIP compression.

ZIP

Works well on images with large areas of single colors or repeating patterns, and for black-and-white images that contain repeating patterns. ZIP compression can be lossless or lossy, depending on the Image Quality setting.

JPEG 2000

Is the international standard for the compression and packaging of image data. Like JPEG compression, JPEG 2000 compression is suitable for grayscale or color images. It also provides additional advantages, such as progressive display. The JPEG 2000 option is only available when Compatibility is set to Acrobat 6 (PDF 1.5) or later.

Automatic (JPEG 2000)

Determines automatically the best quality for color and grayscale images. The Automatic (JPEG 2000) option is only available when Compatibility is set to Acrobat 6 (PDF 1.5) or later.

CCITT And Run Length

Are only available for monochrome bitmap images. CCITT (Consultative Committee on International Telegraphy and Telephony) compression is appropriate for black-and-white images and any images scanned with an image depth of 1 bit. Group 4 is a general-purpose method that produces good compression for most monochrome images. Group 3, used by most fax machines, compresses monochrome bitmaps one row at a time. Run Length compression produces the best results for images that contain large areas of solid black or white.

Note: Grayscale images that have been colorized in InDesign are subject to the compression settings for Color Images. However, grayscale images colorized with a spot color (and [None] applied to their frames) use the compression settings for grayscale.

Image Quality Determines the amount of compression that is applied. For JPEG or JPEG 2000 compression, you can choose Minimum, Low, Medium, High, or Maximum quality. For ZIP compression, only 8-bit is available. Because InDesign uses the lossless ZIP method, data is not

removed to reduce file size, so image quality is not affected.

Tile Size Determines the size of the tiles for progressive display. This option is only available when Compatibility is set to Acrobat 6 (1.5) and later, and Compression is set to JPEG 2000.

Compress Text And Line Art Applies Flate compression (which is similar to ZIP compression for images) to all text and line art in the document, without loss of detail or quality.

Crop Image Data To Frames May reduce file size by exporting only image data that falls within the visible portion of the frame. Do not select this option if postprocessors might require the additional information (for repositioning or bleeding an image, for example).

[To the top](#)

Marks and Bleeds options for PDFs

Bleed is the amount of artwork that falls outside of the printing bounding box, or outside the crop marks and trim marks. You can include bleed in your artwork as a margin of error, to ensure that the ink extends all the way to the edge of the page after the page is trimmed or to ensure that a graphic can be stripped into a keyline in a document.

You can specify the extent of the bleed and add a variety of printer's marks to the file.

[To the top](#)

Color management and PDF/X output options for PDFs

You can set the following options in the Output area of the Export Adobe PDF dialog box. Interactions between Output options change depending on whether color management is on or off, whether the document is tagged with color profiles, and which PDF standard is selected.

Note: For quick definitions of the options in the Output area, position the pointer over an option and read the Description text box at the bottom of the dialog box.

Color Conversion Specifies how to represent color information in the Adobe PDF file. All spot color information is preserved during color conversion; only the process color equivalents convert to the designated color space.

No Color Conversion Preserves color data as is. This is the default when PDF/X-3 is selected.

Convert to Destination Converts all colors to the profile selected for Destination. Whether the profile is included or not is determined by the Profile Inclusion Policy.

Convert to Destination (Preserve Numbers) Converts colors to the destination profile space only if they have embedded profiles that differ from the destination profile (or if they are RGB colors, and the destination profile is CMYK, or vice versa). Untagged color objects (those without embedded profiles) and native objects (such as line art or type) are not converted. This option is not available if color management is off. Whether the profile is included or not is determined by the Profile Inclusion Policy.

Destination Describes the gamut of the final RGB or CMYK output device, such as your monitor or a SWOP standard. Using this profile, InDesign converts the document's color information (defined by the source profile in the Working Spaces section of the Color Settings dialog box) to the color space of the target output device.

Profile Inclusion Policy Determines whether a color profile is included in the file. The options vary, depending on the setting in the Color Conversion menu, whether one of the PDF/X standards is selected, and whether color management is on or off.

Don't Include Profiles Does not create a color-managed document with embedded color profiles.

Include All Profiles Creates a color-managed document. If the application or output device that uses the Adobe PDF file needs to translate colors into another color space, it uses the embedded color space in the profile. Before you select this option, turn on color management and set up profile information.

Include Tagged Source Profiles Leaves device-dependent colors unchanged and preserves device-independent colors as the nearest possible equivalent in PDF. This is a useful option for print shops that have calibrated all their devices, used that information to specify color in the file, and are only outputting to those devices.

Include All RGB And Tagged Source CMYK Profiles Includes any profiles for tagged RGB objects and tagged CMYK objects, such as placed objects with embedded profiles. This option also includes the Document RGB profile for untagged RGB objects.

Include Destination Profile Assigns the destination profile to all objects. If Convert To Destination (Preserve Color Numbers) is selected, untagged objects in the same color space are assigned the destination profile so that color numbers don't change.

Simulate Overprint Simulates the appearance of printing separations by maintaining the appearance of overprinting in composite output. When Simulate Overprint is unselected, Overprint Preview must be selected in Acrobat to see the effects of overlapping colors. When Simulate Overprint is selected, spot colors are changed to their process equivalents, and overlapping colors display and output correctly, without Overprint Preview selected in Acrobat. With Simulate Overprint on, and Compatibility (in the General area of the dialog box) set to Acrobat 4 (PDF 1.3), you can soft-proof your document's colors directly on the monitor before they are reproduced on a particular output device.

Ink Manager Controls whether spot colors are converted to process equivalents and specifies other ink settings. If you make changes to your document using the Ink Manager (for example, if you change all spot colors to their process equivalents), those changes will be reflected in the exported file and in the saved document, but the settings won't be saved with the Adobe PDF preset.

Output Intent Profile Name Specifies the characterized printing condition for the document. An output intent profile is required for creating PDF/X-compliant files. This menu is only available if a PDF/X standard (or preset) is selected in the General area of the Export Adobe PDF dialog box. The available options depend on whether color management is on or off. For example, if color management is off, the menu lists only output profiles that match the destination profile's color space. If color management is on, the output intent profile is the same profile selected for Destination (provided it is a CMYK output device).

Output Condition Name Describes the intended printing condition. This entry can be useful for the intended receiver of the PDF document.

Output Condition Identifier Indicates a pointer to more information on the intended printing condition. The identifier is automatically entered for printing conditions that are included in the ICC registry. This option is not available when using either of the PDF/X-3 presets or standards, because the file would fail compliance when inspected by the Preflight feature in Acrobat 7.0 Professional and later, or the Enfocus PitStop application (which is a plug-in for Acrobat 6.0).

Registry Name Indicates the web address for more information on the registry. The URL is automatically entered for ICC registry names. This option is not available when using either of the PDF/X-3 presets or standards, because the file would fail compliance when inspected by the Preflight feature in Acrobat 7.0 Professional and later, or the Enfocus PitStop application (which is a plug-in for Acrobat 6.0).

[To the top](#)

Font, OPI, and flattening options for PDFs

You can set the following options in the Advanced area of the Export Adobe PDF dialog box.

Subset Fonts When Percent Of Characters Used Is Less Than Sets the threshold for embedding complete fonts based on how many of the font's characters are used in the document. If the percentage of characters used in the document for any given font is exceeded, then that specific font is completely embedded. Otherwise, the font is subsetted. Embedding complete fonts increases file size, but if you want to make sure you completely embed all fonts, enter 0 (zero). You can also set a threshold in the General Preferences dialog box to trigger font subsetting based on the number of glyphs a font contains.

OPI Lets you selectively omit different imported graphics types when sending image data to a printer or file, leaving only the OPI links (comments) for later handling by an OPI server.

Preset If Compatibility (in the General area of the dialog box) is set to Acrobat 4 (PDF 1.3), you can specify a preset (or set of options) for flattening transparency. These options are only used when exporting spreads with transparency in artwork.

Note: Acrobat 5 (PDF 1.4) and later automatically preserve transparency in artwork. As a result, the Preset and Custom options are not available for these levels of compatibility.

Ignore Spread Overrides Applies the flattener settings to all spreads in a document or book, overriding the flattener preset on an individual spread.

Create JDF File Using Acrobat Creates a Job Definition Format (JDF) file and starts Acrobat Professional for processing the JDF file. A job definition in Acrobat contains references to the files to be printed as well as instructions and information for prepress service providers at the production site. This option is only available if Acrobat 7.0 Professional or later is installed on your machine. For more information, see Acrobat Help.

[To the top](#)

Adding security to PDF files

When saving as PDF, you can add password protection and security restrictions, limiting not only who can open the file, but also who can copy or extract contents, print the document, and more.

A PDF file can require passwords to open a document (document open password) and to change security settings (permissions password). If you set any security restrictions in your file, you should set both passwords; otherwise, anyone who opens the file could remove the restrictions. If a file is opened with a permissions password, the security restrictions are temporarily disabled.

The RC4 method of security from RSA Corporation is used to password-protect PDF files. Depending on the Compatibility setting (in the General category), the encryption level will be high or low.

Note: Adobe PDF presets don't support passwords and security settings. If you select passwords and security settings in the Export Adobe PDF dialog box, and then click Save Preset, the passwords and security settings won't be preserved.

[To the top](#)

Security options for PDFs

You can set the following options when you create a PDF or when you apply password protection to a PDF. Options vary depending on the Compatibility setting. Security options are not available for PDF/X standards or presets.

Compatibility Sets the type of encryption for opening a password-protected document. The Acrobat 4 (PDF 1.3) option uses a low encryption level (40-bit RC4), while the other options use a high encryption level (128-bit RC4 or AES).

Be aware that anyone using an earlier version of Acrobat cannot open a PDF document with a higher compatibility setting. For example, if you select the Acrobat 7 (PDF 1.6) option, the document cannot be opened in Acrobat 6.0 or earlier.

Require A Password To Open The Document Select this option to require users to type the password you specify to open the document.

Document Open Password Specify the password that users must type to open the PDF file.

Note: If you forget a password, there is no way to recover it from the document. It's a good idea to store passwords in a separate secure location in case you forget them.

Use A Password To Restrict Printing, Editing And Other Tasks Restricts access to the PDF file's security settings. If the file is opened in Adobe Acrobat, the user can view the file but must enter the specified Permissions password in order to change the file's Security and Permissions settings. If the file is opened in Illustrator, Adobe Photoshop, or Adobe InDesign, the user must enter the Permissions password, since it is not possible to open the file in a view-only mode.

Permissions Password Specify a password that is required to change the permissions settings. This option is available only if the previous option is selected.

Printing Allowed Specifies the level of printing that users are allowed for the PDF document.

None Prevents users from printing the document.

Low Resolution (150 dpi) Lets users print at no higher than 150-dpi resolution. Printing may be slower because each page is printed as

a bitmap image. This option is available only if the Compatibility option is set to Acrobat 5 (PDF 1.4) or later.

High Resolution Lets users print at any resolution, directing high-quality vector output to Adobe PostScript and other printers that support advanced high-quality printing features.

Changes Allowed Defines which editing actions are allowed in the PDF document.

None Prevents users from making any changes to the document that are listed in the Changes Allowed menu, such as filling in form fields and adding comments.

Inserting, Deleting, And Rotating Pages Lets users insert, delete, and rotate pages, and create bookmarks and thumbnails. This option is only available for high (128-bit RC4 or AES) encryption.

Filling In Form Fields And Signing Lets users fill in forms and add digital signatures. This option doesn't allow them to add comments or create form fields. This option is only available for high (128-bit RC4 or AES) encryption.

Commenting, Filling In Form Fields, And Signing Lets users add comments and digital signatures, and fill in forms. This option doesn't allow users to move page objects or create form fields.

Page Layout, Filling in Form Fields, And Signing Lets users insert, rotate, or delete pages and create bookmarks or thumbnail images, fill out forms, and add digital signatures. This option doesn't allow them to create form fields. This option is only available for low (40-bit RC4) encryption.

Any Except Extracting Pages Lets users edit the document, create and fill in form fields, and add comments and digital signatures.

Enable Copying Of Text, Images, And Other Content Lets users select and copy the contents of a PDF.

Enable Copying Of Content And Access For The Visually Impaired Lets visually impaired users use screen readers to read and copy the document. This option is only available for low (40-bit RC4) encryption.

Enable Text Access For Screen Reader Devices For The Visually Impaired Lets visually impaired users read the document with screen readers, but doesn't allow users to copy or extract the document's contents. This option is available only for high (128-bit RC4 or AES) encryption.

Enable Plaintext Metadata Allows users to copy and extract content from the PDF. This option is only available when Compatibility is set to Acrobat 6 (PDF 1.5) or later. Selecting this option allows storage/search systems and search engines to access metadata stored in the document.

[To the top](#)

Font embedding and substitution

A font can be embedded only if it contains a setting by the font vendor that permits it to be embedded. Embedding prevents font substitution when readers view or print the file, and ensures that readers see the text in its original font. Embedding increases file size only slightly, unless the document uses CID fonts, a font format commonly used for Asian languages. You can embed or substitute fonts in Acrobat or when you export an InDesign document to PDF.

You can embed the entire font, or just a subset of the characters used in the file.

When a font cannot be embedded due to the font vendor settings, and someone who opens or prints a PDF does not have access to the original font, another font is temporarily substituted. To avoid problems, print only PDF files in which fonts can be embedded.

The Multiple Master typeface can stretch or condense to fit, to ensure that line and page breaks in the original document are maintained. The substitution cannot always match the shape of the original characters, however, especially if the characters are unconventional ones, such as script typefaces.



If characters are unconventional (left), the substitution font does not match (right).

[To the top](#)

Preparing a document for on-screen viewing

With its small file sizes, platform independence, and online navigation, Adobe PDF is an ideal format for distributing documents electronically and viewing them on-screen. You can send Adobe PDF documents to other users as e-mail attachments, or you can distribute the documents on the web or on an intranet.

For information on creating accessible PDF documents, see [Adobe InDesign CS4 accessibility](#).

The following guidelines apply to electronically distributed Adobe PDF files:

- Before putting Adobe PDF documents on a website, check to see that the text, artwork, and layout in the documents are complete and correct.
- Make sure that table of contents entries, hyperlinks, and bookmarks are generated correctly. Table of contents entries are generated automatically from information in the Bookmarks panel.
- Set up passwords and other security options.
- Use a file name of no more than eight characters, followed by an extension of up to three characters. Many networks and e-mail programs shorten long file names.
- Make sure that the file name has a PDF extension if users will view the file on a Windows computer or on the Internet.
- To apply predefined Adobe PDF export settings for on-screen viewing, choose Smallest File Size.

Note: Adobe PDF files exported from InDesign documents that contain overprints or transparency effects are best viewed in Acrobat 5.0 and later, or Adobe Reader 7.0 and later, with the Overprint Preview option selected.

Adobe also recommends

- Export to PDF for printing
- Buttons
- Customize Adobe PDF presets

 Twitter™ and Facebook posts are not covered under the terms of Creative Commons.

[Legal Notices](#) | [Online Privacy Policy](#)

Printing

[Printing booklets using your desktop printer](#)

Jeff Witchel (Oct. 15, 2012)

video-tutorial

Learn how to create a booklet and print it using your desktop printer

[Adobe Creative Suite 5/5.5 Printing Guide \(PDF, 21 MB\)](#)

article (Jan. 1, 2011)

Download this guide to learn how to set up Adobe documents for print. All the information you need for professional printing in one place.

Preparing PDFs for service providers

[About PDF print publishing tools](#)
[Checking your document before exporting](#)
[Produce a print-ready Adobe PDF file](#)

[To the top](#)

About PDF print publishing tools

In some print publishing workflows, documents are distributed in the format of the authoring application (called the *native* format). Once approved, the files are saved in PostScript or a proprietary format for prepress work and final printing. Because applications generate PostScript in many different ways, PostScript files may be arbitrarily large and complex. In addition, reliability problems such as missing fonts, corrupt files, missing graphic elements, and unsupported features can result at output time. In response, Adobe and its partners continue to create reliable, PDF-based publishing workflow solutions.

From InDesign, you can export your document to a composite PDF file called a *digital master*. These digital masters are compact, reliable files that you or your service provider can view, edit, organize, and proof. Then, at the appropriate time in the workflow, your service provider can either output the PDF directly, or process it using tools from various sources for post-processing tasks such as preflight checks, trapping, imposition, and color separation.

PDF files in the workflow

Many large publishers use PDFs to streamline their review and production cycles. For example, numerous magazines and newspapers have adopted PDF as the standard format for delivering advertisements to local publishing offices via satellite or ISDN lines. PDFs enable local publishers to instantly view an advertisement exactly as it was designed, make late-stage text edits, and reliably print from any computer.

PDF workflow technologies and requirements

Adobe is continually addressing the workflow needs of service providers, and recommends that you visit the Adobe website at www.adobe.com often for the latest developments. Currently, Adobe addresses publishing workflow needs by providing an integrated system of several technologies:

- Adobe Acrobat 9, with its support for Adobe PDF version 1.7.
- Adobe PostScript 3 printing technology, for device-independent support, Adobe In-RIP Trapping, in-RIP color separations, and smooth blends.
- Adobe InDesign CS4, with its high-resolution page layout capabilities and direct PDF processing.
- PDF/X, an ISO standard for graphic content exchange that eliminates many of the color, font, and trapping variables that lead to printing problems.

A high-resolution composite PDF workflow typically includes a PostScript 3 output device whose RIP supports in-RIP separations. Therefore, if your output device uses PostScript Level 2 or does not support in-RIP separations, use a pre-separated PostScript printing workflow.

[To the top](#)

Checking your document before exporting

Before creating a PDF for a service provider, make sure that the InDesign document meets your service provider's specifications. The following list offers some recommendations:

- Use the InDesign Preflight feature to ensure that image resolution and color spaces are correct, that fonts are available and can be embedded, that graphics are up-to-date, and so on.
- View your Adobe PDF export settings prior to exporting, and then adjust them as necessary. The Summary area includes a warning section that indicates when preset settings can't be honored.
- If your artwork contains transparency (including overprints and drop shadows) and you require high-resolution output, it's a good idea to preview the effects of flattening using the Flattener Preview panel before saving the file.
- If your artwork contains transparency, ask your prepress service provider if they want to receive flattened or unflattened PDF files. Flattening should be done as late in the workflow as possible, preferably by the service provider. However, if your service provider wants you to flatten transparency, submit a PDF/X-1a compliant file.
- If your document will be separated, you can preview the separations and ink coverage limits using the Separations Preview panel.
- Use only high-resolution images in your document.
- For best results, use only CMYK images in a four-color-process job. Alternatively, you can choose to convert RGB images to CMYK in the Export Adobe PDF dialog box (Output category).
- You can exclude hidden or nonprinting layers from the exported PDF document. (See Choose which layers are printed or exported to PDF.)

For detailed information about preparing InDesign documents for high-resolution PDF output, see the [Adobe InDesign CS Printing Guide for Prepress Service Providers](#).

[To the top](#)

Produce a print-ready Adobe PDF file

A service provider can use Acrobat 7.0 Professional and later to perform preflight checks and color separations. Subsequent versions of Acrobat Professional contain more advanced preflight tools, including the ability to make certain corrections automatically. Various prepress applications and in-RIP technologies can also perform preflight checks, do trapping and imposition, and make the color separations of the pages in the digital master.

If you choose to leave out the images when creating the Adobe PDF file, make sure that the service provider has access to the original high-resolution images that are required for proper output. In addition, make sure that the service provider has Acrobat 7.0 or later for accurate viewing of text and color graphics. For best viewing, they should use Acrobat 8 Professional or later.

If you're using a color-managed workflow, you can use the precision of color profiles to perform an on-screen preview (a *soft proof*). You can examine how your document's colors will look when reproduced on a particular output device.

Note: *Unless you are using a color management system (CMS) with accurately calibrated ICC profiles and are sure you have properly calibrated your monitor, don't rely on the on-screen appearance of colors.*

1. Prepare the document for exporting to Adobe PDF.
2. Export using the .joboptions file provided by your service provider. If you don't have a preferred .joboptions file, use a PDF/X preset.
3. Preflight the PDF in Acrobat 7.0 Professional or later.
4. Proof and correct the PDF file.
5. Hand off the press-ready PDF to the prepress service provider.

Adobe also recommends

 Twitter™ and Facebook posts are not covered under the terms of Creative Commons.

[Legal Notices](#) | [Online Privacy Policy](#)

Preflighting files before handoff

- [Preflight panel overview](#)
- [Define preflight profiles](#)
- [View and resolve preflight errors](#)
- [Preflight books](#)
- [Package files](#)

For detailed information and instructions, click the links below.

[To the top](#)

Preflight panel overview

Before printing or handing off the document to a service provider, you can perform a quality check on the document. *Preflight* is the industry-standard term for this process. While you edit your document, the Preflight panel warns of problems that can prevent a document or book from printing or outputting as desired. These problems include missing files or fonts, low-resolution images, overset text, and a number of other conditions.

You can configure preflight settings to define which conditions are detected. These preflight settings are stored in preflight profiles for easy reuse. You can create your own preflight profiles or import them from your printer or another source.

To take advantage of live preflighting, create or specify a preflight profile in the early stages of creating a document. If Preflight is turned on, a red circle icon appears in the status bar when InDesign detects any problems. You can open the Preflight panel and view the Info section to get basic guidance for fixing the problems.

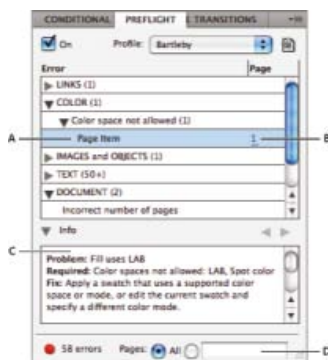

Preflight panel

A. Selected error **B.** Click page number to view page item **C.** Info area offers suggestions for fixing the selected error **D.** Specify a page range to limit error checking

Open the Preflight panel

- Choose Window > Output > Preflight.
- Double-click the Preflight icon at the bottom of document window. The Preflight icon is green if no errors are detected or red if errors are detected.

[To the top](#)

Define preflight profiles

By default, the [Basic] profile is applied to new and converted documents. This profile flags missing or modified links, overset text, and missing fonts. Although you cannot edit or delete the [Basic] profile, you can create and use multiple profiles. For example, you can switch between profiles when working on different documents, when using different print service providers, or when running a single document through different production phases.

Consult with your prepress provider to obtain a profile or to learn what the preflight profile settings are.

Define a preflight profile

1. Choose Define Profiles from the Preflight panel menu or from the Preflight menu at the bottom of the document window.
2. Click the New Preflight Profile icon , and specify a name for the profile.
3. In each category, specify the preflight settings. A check mark in a box indicates that all settings are included. An empty box indicates that no settings are included.

Links Determine whether missing links and modified links are displayed as errors.

Color Determine which transparency blending space is required and whether items such as CMY plates, colorspaces, and overprinting are allowed.

Images and Objects Specify requirements for items such as image resolution, transparency, and stroke thickness.

Text The Text category displays errors for items such as missing fonts and overset text.

Document Specify requirements for page size and orientation, number of pages, blank pages, and bleed and slug setup.

4. Choose Save to preserve your changes on one profile before working on another profile. Or click OK to close the dialog box and save all changes.

Embed and unembed profiles

When you embed a profile, you make the profile part of the document. Embedding profiles is especially useful when you're sending the file to someone else. Just because the profile is embedded does not mean it must be used. For example, if you send a document with an embedded profile to a print service, the printer can select a different profile to use with the document.

You can embed only one profile. The [Basic] profile cannot be embedded.

1. To embed a profile, select it in the Profile list, and then click the Embed icon  to the right of the Profile list.

You can also embed a profile in the Define Profiles dialog box.

2. To unembed a profile, choose Define Profiles from the Preflight panel menu, select the profile, and then choose Unembed Profile from the Preflight Profile Menu on the left side of the dialog box.

Export and load profiles

You can export a profile to make it available to others. Exported profiles are saved with a .idpp extension.

 *Exporting a profile is a good way to back up your profile settings. When you restore preferences, your profile information is reset. If you need to*

restore preferences, you can simply load your exported profile.

You can also load a profile that someone else has made available to you. You can load a *.idpp file, or you can load the embedded profile in the document you specify.

- To export a profile, choose Define Profiles from the Preflight menu. Choose Export Profile from the Preflight Profile Menu, specify the name and location, and click Save.
- To load (import) a profile, choose Define Profiles from the Preflight menu. Choose Load Profile from the Preflight Profile Menu, select the *.idpp file or document containing an embedded profile you want to use, and click Open.

Delete a profile

1. Choose Define Profiles from the Preflight menu.
2. Select the profile you want to delete, and then click the Delete Preflight Profile icon .
3. Click OK to delete the profile.

[To the top](#)

View and resolve preflight errors

In the error list, only the categories with errors are listed. You can click the arrow next to each item to expand or collapse it.

When viewing the list of errors, note the following issues:

- In some cases, a design element such as a swatch or a paragraph style is causing the problem. The design element itself is not reported as an error. Instead, any page item to which the design element is applied appears in the error list. In such cases, make sure that you resolve the issue in the design element.
- Errors that occur in overset text, hidden conditions, or notes are not listed. Deleted text that is still available in tracked changes is also ignored.
- A master page item with a problem is not listed if the master is unapplied, or if no page it is applied to is in the current scope. If an master page item has an error, the Preflight panel lists it only once, even though the error is repeated on every page to which the master is applied.
- Errors that occur in non-printing page items, in page items on the pasteboard, or in hidden or non-printing layers appear in the error list only if the appropriate options are specified in the Preflight Options dialog box.
- If you need to output only certain pages, you can limit preflight checking to a page range. Specify a page range at the bottom of the Preflight panel.

Turn on or off live preflighting

By default, preflighting is turned on for all documents.

1. To turn on or off preflighting for the active document, select the On option in the upper-left corner of the Preflight panel, or choose Preflight Document from the Preflight menu at the bottom of the document window.
2. To turn on or off preflighting for all documents, select Enable Preflight For All Documents from the Preflight panel menu.

Resolve errors

1. In the error list, double-click a row or click the page number in the Page column to view the page item.
2. Click the arrow to the left of Info to view information on the selected row.
The Info panel includes a description of the problem and offers suggestions for fixing it.
3. Fix the error.

Select a different profile

Using different profiles is useful in many workflows. For example, you can select different profiles for documents you're editing at the same time, or you can select a new profile to begin a new production phase. When you select a different profile, the document is reexamined.

1. Open the document.
2. In the Preflight panel, select a profile from the Profile menu.

If you want to use this profile whenever you work on this document, embed the profile. Otherwise, the document opens using the default working profile.

Specify a page range for preflighting

- At the bottom of the Preflight panel, specify the page range (such as **1-8**).

The rules for specifying page ranges are the same as in the Print dialog box. Errors that appear on pages outside this page range are omitted from the error list.

Set Preflight options

1. Choose Preflight Options from the Preflight panel menu.
2. Specify the following options, and then click OK.

Working Profile Select the profile to use as the default for new documents. If you want the working profile to be embedded in new documents, select Embed Working Profile Into New Documents. See [Define preflight profiles](#).

Use Embedded Profile / Use Working Profile When you open a document, determine whether its embedded profile or the specified working profile is used for preflighting.

Layers Specify whether items on all layers, visible layers, or visible and printable layers are included in preflighting. For example, if an item is on a hidden layer, you can prevent errors from being reported on that item.

Non-Printing Objects Select this option to report errors on objects marked as non-printing in the Attributes panel or on master page objects on pages to which Hide Master Items has been applied.

Objects On Pasteboard Select this option to report errors on objects placed on the pasteboard.

Limit the number of rows per error

You can keep your error lists more manageable by limiting the number of rows per error. For example, in a document that should not use TrueType fonts, a single TrueType font used throughout the document can generate hundreds of errors. If you limited the number of rows per error to 25, only the first 25 errors appear in the list, and (25+) appears next to the error.

- Choose Limit Number Of Rows Per Error from the Preflight panel menu, and then choose the number.

Save error report

You can generate a text-only or PDF file that lists the errors displayed in the Preflight panel. The report also includes other statistics such as time, document name, and profile name.

 For a full inventory of the document that includes all fonts, inks, links, and other items used, create a report using the Package feature.

1. Choose Save Report from the Preflight panel menu.
2. Specify whether you want to save the file as a PDF or text file from the Save As Type (Windows) or Format (Mac OS) menu.
3. Specify the name and location of the report, and then click Save.

[To the top](#)

Preflight books

Choosing Preflight Book from the Book panel menu causes all documents (or all selected documents) to be examined for errors. You can use the profile embedded in each document, or you can specify a profile to use. A green, red, or question mark icon indicates the preflight status of each document. Green indicates the document has no reported errors. Red indicates errors. A question mark indicates an unknown status. For example, the document may be closed, preflighting may be turned off, or the preflight profile was changed.

Set preflight options in a book

1. Choose Preflight Book from the book panel menu.
2. In the Preflight Book Options dialog box, specify whether you want the preflight options to apply to the entire book or only to selected documents.
3. Under Preflight Profile, indicate whether you want to use the profile specified in the Use Profile menu or the embedded profile of each document.

The profile you specify is temporarily used for each document. When you close and open any of the individual documents, either the working profile or the embedded profile is used, depending on which option is specified in the Preflight Options dialog box.

4. Under Include, determine which items are included in the error list.

Layers Specify whether items on all layers, visible layers, or visible and printable layers are included in preflighting. For example, if an item

is on a hidden layer, you can choose not to view errors reported on that item.

Objects On Pasteboard Select this option to report errors on objects placed on the pasteboard.

Non-Printing Objects Select this option to report errors on objects marked as non-printing in the Attributes panel.

5. Select Generate Report to generate a text or PDF file containing a list of errors. The generated report lists all errors in the book.
6. Click Preflight.

Resolve preflight errors in a book

When a red dot appears to the right of a document name in the book panel, the document contains preflight errors.

1. In the Book panel, double-click the document containing errors.
2. Use the Preflight panel to view the errors in each document, and make the necessary changes to fix the problems.

Design elements such as styles or swatches may cause errors. In such cases, make sure that you resolve the errors in the styles or swatches of the style source document, and then synchronize the book.

If you specified a profile to be used in book preflight that is not the embedded document profile, keep in mind that a different profile may be selected when you open the document again. The different profile may result in different preflight errors.

[To the top](#)

Package files

You can gather the files you've used, including fonts and linked graphics, for easy handoff to a service provider. When you package a file, you create a folder that contains the InDesign document (or documents in a book file), any necessary fonts, linked graphics, text files, and a customized report. This report, which is saved as a text file, includes the information in the Printing Instructions dialog box; a list of all used fonts, links, and inks required to print the document; and print settings.

InDesign performs an up-to-date preflight check. The Package Inventory dialog box indicates any detected problem areas. You can also give your service provider a composite PDF file made from your document or a PostScript file.

1. Do one of the following to open the Package dialog box:
 - Choose File > Package. (If Package does not appear in the File menu, try choosing a different workspace, such as Window > Workspace > Advanced.)
 - In the Book panel menu, choose Package Book or Package Selected Documents, depending on whether all, some, or none of the documents are selected in the Book panel.

An alert icon  indicates problem areas.

2. In the Package Inventory dialog box, do one of the following:
 - If you're notified of problems, click Cancel, and use the Preflight panel to resolve problem areas.
 - Click the problem area (such as Fonts) and then correct the problem. When you're satisfied with the document, begin the packaging process again.

- Click Package to begin packaging.
3. Fill in the printing instructions. The filename you type is the name of the report that accompanies all other packaging files.
 4. Click Continue, and then specify a location in which to save all packaging files.
 5. Select the following, as needed:

Copy Fonts Copies all necessary font files, not the entire typeface.

Copy Linked Graphics Copies linked graphics files to package folder location.

Update Graphic Links In Package Changes graphic links to the package folder location.

Use Document Hyphenation Exceptions Only If this option is selected, InDesign flags this document so that it doesn't reflow when someone else opens or edits it on a computer that has different hyphenation and dictionary settings. You can turn on this option when sending the file to a service provider.

Include Fonts And Links From Hidden And Non-Printing Content Packages the objects located on hidden layers, hidden conditions, and layers for which the Print Layer option is turned off. When this option is not selected, the package includes only what is visible and printable in the document when you create the package.

View Report Opens the printing instructions report in a text editor immediately after packaging. To edit the printing instructions before completing the packaging process, click the Instructions button.

6. Click Package to continue packaging.

Correct font errors

The Fonts area of the Package Inventory dialog box lists all fonts used in the document—including fonts applied to overset text or text on the pasteboard, and fonts embedded in EPS files, native Adobe Illustrator files, and placed PDF pages—and determines whether the font is installed on your computer and available. Selecting Show Problems Only shows fonts that fit into the following categories:

Missing fonts Lists fonts that are used in the document but are not installed on the current computer or available as document installed fonts.

Incomplete fonts Lists fonts that have a screen font on the current computer but not a corresponding printer font.

Protected fonts Lists fonts that cannot be embedded in PDF or EPS files or used as document installed fonts due to license restrictions.

- Do either of the following:
 - Close the Preflight dialog box and install the fonts on your computer.
 - Click Find Font in the Fonts area of the Preflight dialog box, and search for, list, and replace fonts used in your document.

Make sure that the fonts used in the document are licensed, installed, and activated either on your computer or on the output device.

Repair links and images

The Links And Images area of the Package Inventory dialog box lists all links, embedded images, and placed InDesign files used in the document, including DCS and OPI links from linked EPS graphics. Images embedded in EPS graphics and placed InDesign files are not included as links in the preflight report. The preflight utility indicates missing or out-of-date links, and any RGB images (which may not separate properly unless color management is on and set up correctly).

Note: *The Package Inventory dialog box cannot detect RGB images embedded in placed EPS, Adobe Illustrator, Adobe PDF, FreeHand files, and placed .INDD files. For best results, verify color data for placed graphics using the Preflight panel or in their original applications.*

1. To view only problem images, select Show Problems Only in the Links And Images area of the Package Inventory dialog box.
2. To repair a link, do one of the following:
 - Select the problem image and click either Update or Relink.
 - Click Repair All.
3. Locate the correct image files and click Open.

Adobe also recommends

 Twitter™ and Facebook posts are not covered under the terms of Creative Commons.

[Legal Notices](#) | [Online Privacy Policy](#)

Preparing to print separations

Creating separations

[Prepare your document for color separations](#)

[Outputting spot colors](#)

[View the process color equivalents of a spot color](#)

[Print an object on all color plates](#)

[Printing gradients as separations](#)

[Printing a composite](#)

[Preview color separations](#)

For detailed information and instructions, click the links below.

[To the top](#)

Creating separations

To reproduce color and continuous-tone images, printers usually separate artwork into four plates—one plate for each of the cyan (C), yellow (Y), magenta (M), and black (K) portions of the image. When inked with the appropriate color and printed in register with one another, these colors combine to reproduce the original artwork. The process of dividing the image into two or more colors is called color separating, and the films from which the plates are created are called the *separations*.

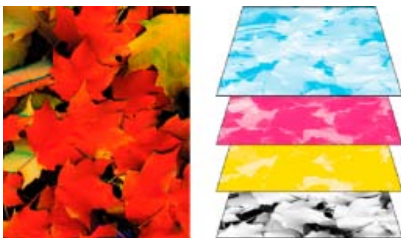

Composite (left) and separations (right)

Separation workflows

Adobe InDesign CS4 supports two common PostScript workflows; the main difference is where separations are created—at the *host computer* (the system using InDesign and the printer driver), or at the output device's RIP (raster image processor). Another alternative is a PDF workflow.

Host-based separations In the traditional host-based, pre-separated workflow, InDesign creates PostScript information for each of the separations required for the document, and sends that information to the output device.

In-RIP separations In the newer RIP-based workflow, a new generation of PostScript RIPs performs color separations, trapping, and even color management at the RIP, leaving the host computer free to perform other tasks. This approach takes less time for InDesign to generate the file, and minimizes the amount of data transmitted for any given print job. For example, instead of sending PostScript information for four or more pages to print host-based color separations, InDesign sends the PostScript information for a single composite PostScript file for processing in the RIP.

[To the top](#)

Prepare your document for color separations

1. Correct any color problems in your artwork.

2. Set overprint options.
3. Create trapping instructions to compensate for misregistration on press.
4. Preview color separations on your screen.
Note: Steps 1–4 are recommended but not required in producing color separations.
5. Choose File > Print to display the Print dialog box.
6. If you've created a printer preset with the appropriate separation settings, select it in the Print Preset menu at the top of the Print dialog box.
7. Choose a printer or PostScript file in the Printer menu.
8. If you're printing to a PostScript file, choose the PPD for the device that will output the separations.
9. To view or change existing print options, click a section name on the left side of the Print dialog box.
10. Before you deliver your document to a service provider, proof the separations.
11. Print or save separations.

[To the top](#)

Outputting spot colors

You can use custom inks, called *spot colors*, in addition to, or in place of, process colors. For example, instead of using the four process colors to reproduce artwork consisting of black text and bluish-green line drawings, you could use two spot colors—one of black, and one representing the exact shade of green. You can also use spot color inks to produce colors not reproducible by CMYK inks, such as varnishes or fluorescent and metallic colors. In addition, you can mix two or more spot colors together or mix spot colors with process colors to create mixed inks.

You can color artwork with process colors, spot colors, or a combination of both. When printing separations, you can convert spot colors to their process color equivalents so that they will be printed on the CMYK plates.

[To the top](#)

View the process color equivalents of a spot color

1. Select the spot color in the Swatches panel.
2. Choose CMYK in the Color panel menu.

The CMYK equivalent values for the spot color are displayed in the Color panel.

 You can also hold the pointer over the spot color in the Swatches panel. The formula for the color will appear in the tool tip.

[To the top](#)

Print an object on all color plates

If you want an object to print on all plates in the printing process, including spot color plates, you can apply registration color to the object. Registration color is used for crop marks and trim marks. For composite output, objects with registration color applied will print as C 100, M 100, Y 100, and K 100. For separations, these objects will print as 100% on each plate.

1. Select the objects to which you want to apply registration color.
2. Choose Window > Swatches.
3. In the Swatches panel, click the Registration color swatch .

[To the top](#)

Printing gradients as separations

Consider the following when producing separations for documents with gradients:

- A gradient created in InDesign that contains a combination of spot and process colors will be separated onto both the process and spot plates.
- A gradient that contains process colors will be separated onto the process plates.
- A gradient that contains two tints of the same spot color will be separated onto a single spot color plate.
- To create a gradient that separates on one piece of film between a spot color and white, create a gradient fill between the spot color and the Paper swatch in the Swatches panel.
- If you create a gradient between two spot colors, you should assign different screen angles to those spot colors. If two spot colors have the same screen angle, they will overprint each other. If you're not sure what the angles should be, consult with your prepress service provider.

[To the top](#)

Printing a composite

You can print a color or grayscale composite proof to check colors in your document. A composite image can help you design and proof your layout before you print final (and costly) separations.

When InDesign prints a composite, it prints all of the colors used in the file on one plate, regardless of whether any individual colors are selected.

Consider the following issues when printing composites:

- While no proof will give you an exact representation of your final output, you can greatly improve its accuracy by calibrating all the devices you use to create a document (such as scanners, monitors, and printers). If the devices are calibrated, the color management system can help you get predictable and consistent color.
- Any overprinting options that you've selected in the document will print correctly on a printer that supports overprinting. Since most desktop printers don't support overprinting, you can simulate the effects of overprinting by selecting Simulate Overprint in the Output section of the Print dialog box.

Note: *Selecting Simulate Overprint will convert spot colors to process colors for printing. If you intend to use a file for separations on a RIP, or for final output, do not select this option.*

- When you print to a black-and-white printer, InDesign produces a grayscale composite version of the pages. If the document contains color, InDesign prints visually correct grays to simulate that color. For example, the gray that simulates a 20% tint of yellow is lighter than a 20% tint of black, since yellow is visually lighter than black.
- When you print a book with chapters containing conflicting spot inks or trap styles, you can instruct InDesign to synchronize settings with the master document.
- If you're using color management with the Book feature, make sure that each document in the book uses the same color management settings in the Color Settings dialog box.

Note: *Remember that, like monitors, color printers vary greatly in color reproduction quality; thus, proofs from your service provider are the best way to verify how the finished piece will look.*

[To the top](#)

Preview color separations

You can preview color separations, ink coverage limits, and overprinting using the Separations Preview panel. Previewing separations on your monitor lets you check the following:

Varnishes and other coatings Since varnishes are transparent, they can be difficult to preview on-screen. When you preview a varnish separation by itself, the varnished areas appear in black.

Rich black Previewing separations lets you identify areas that will print as rich black, or process black (K) ink mixed with color inks for increased opacity and richer color.

Ink coverage Too much ink on the paper can cause drying problems. Ask your commercial printer for the maximum ink coverage of the press you will be printing on. You can then preview the document to identify areas where ink coverage exceeds the press's limit.



Overprinting You can preview how blending, transparency, and overprinting will appear in color-separated output.

Note: *You can also see overprinting effects when you output to a composite printing device. This is useful for proofing color separations.*

While previewing separations on your monitor can help you detect problems without the expense of printing separations, it does not let you preview trapping, emulsion options, printer's marks, and halftone screens and resolution. Work with your commercial printer to verify these settings using integral or overlay proofs.

Note: *Objects on hidden layers are not included in an on-screen preview.*

Preview separation plates

1. Choose Window > Output > Separations Preview.
2. For View, choose Separations.
3. Do any of the following:
 - To view a single separation and hide all others, click the name of the separation you want to view. By default, areas of coverage appear in black. To change this, deselect Show Single Plates In Black on the panel menu.
 - To view one or more separations, click the empty box to the left of each separation name. Each separation appears in its assigned color.
 - To hide one or more separations, click the eye icon  to the left of each separation name.
 - To view all process plates at once, click the CMYK icon .
 - To view all separations at once, click and drag the pointer across all of the eye icons (or empty boxes) next to the separation names.

 *The Separations Preview panel can also be controlled using keyboard shortcuts.*



Previewing a single separation (left) and multiple separations (right)

Preview ink coverage

1. Choose Window > Output > Separations Preview.
2. For View, choose Ink Limit. Enter a value for maximum ink coverage in the box that appears next to the View menu. (Ask your commercial printer for the correct value to enter.)
3. Verify ink coverage in the document preview. Areas that exceed the ink coverage limit are shown in shades of red (dark red areas exceed the ink coverage limit by more than light red areas). All other areas appear in grayscale.



Areas that exceed the specified ink coverage limit are shown in red.

4. To check ink coverage for a specific area, use the pointer to hover over that area in the document window. Ink coverage percentages appear in the panel next to each ink name.

 *You can adjust ink coverage by converting some spot colors to process colors. To adjust ink coverage in placed graphics, edit the graphics in their source applications.*

Return to normal view

1. Choose Window > Output > Separations Preview.
2. For View, choose Off.

Adobe also recommends

- Export to PDF for printing

 Twitter™ and Facebook posts are not covered under the terms of Creative Commons.

[Legal Notices](#) | [Online Privacy Policy](#)

Printing documents

About printing

[Print a document or book](#)

[Printing documents with multiple page sizes](#)

[Specifying pages to print](#)

[Specify paper size and page orientation](#)

[Choose which layers are printed or exported to PDF](#)

[Printing to non-PostScript language printers](#)

[Print as bitmap](#)

[Preview documents](#)

[Setting up a printer](#)

[Use print presets](#)

For detailed information and instructions, click the links below.

[To the top](#)

About printing

Whether you are providing a multicolored document to an outside service provider, or just sending a quick draft of a document to an inkjet or laser printer, knowing a few basics about printing will make the print job go more smoothly, and help to ensure that the finished document appears as intended.

Types of printing

When you print a file, Adobe InDesign sends it to a printing device—either to be printed directly on paper or to a digital printing press, or to be converted to a positive or negative image on film. In the latter case, the film can then be used to create a master plate for printing by a commercial press.

Types of images

The simplest types of images, such as text, use only one color in one level of gray. A more complex image is one with color tones that vary within the image. This type of image is known as a *continuous-tone image*. A photograph is an example of a continuous-tone image.

Halftoning

To create the illusion of continuous tone, images are broken down into a series of dots. This process is called *halftoning*. Varying the sizes and densities of the dots in a halftone screen creates the optical illusion of variations of gray or continuous color in the printed image.

Color separation

Artwork that will be commercially reproduced and that contains more than a single color must be printed on separate master plates, one for each color. This process is called *color separation*.

Getting detail

The detail in a printed image results from a combination of resolution and screen frequency. The higher an output device's resolution, the finer (higher) the screen frequency you can use.

Duplex printing

Printer-specific features such as duplex printing are available when you click the Printer button in the Print dialog box. Duplex printing is available only if the printer supports it. For information on duplex printing, see your printer documentation.

Transparent objects

If the artwork contains objects with transparency features that you added using the Effects panel or the Drop Shadow or Feather commands, the transparent artwork will be flattened according to settings in the flattener preset you choose. You can affect the ratio of rasterized images to vector images in the printed artwork.

For more information on printing, see the Adobe Print Resource Center at www.adobe.com/go/print_resource. To troubleshoot printing problems, see www.adobe.com/go/learn_id_printtrouble.

[To the top](#)

Print a document or book

1. Make sure that you've installed the correct driver and PPD for your printer.
2. Open the Print dialog box:
 - If you have individual documents open, choose File > Print. This opens the Print dialog box for the current document.
 - If you have either no documents or all documents selected in the Book panel, choose Print Book in the Book panel menu. This will print all documents in a book.
 - If you have some documents selected in the Book panel, choose Print Selected Documents in the Book panel menu.
3. Specify the printer you're using in the Printer menu. If a printer preset has the settings you want, choose it in the Print Preset menu.
4. In the General area, type the number of copies to print, choose whether to collate pages or print them in reverse order, and indicate which pages you want printed.

The Page Range option is unavailable if you're printing a book.

If you're printing a document with multiple page sizes, use the controls above the Range to select a range with all pages of the same size. See [Printing documents with multiple page sizes](#).

5. Indicate whether you want to print nonprinting objects, blank pages, or visible guides and baseline grids.
6. Adjust settings as needed for each area of the Print dialog box.
7. Click Print.

Settings you specify in the Print dialog box are saved with the document.

Page printing options

You can print all pages, even or odd pages only, a series of individual pages, or a contiguous range.

Range Specifies the range of pages to print in the current document. Indicate numbers in a range by using a hyphen, and indicate multiple pages or ranges by using commas or spaces. (See [Specifying pages to print.](#))

If the document includes pages with different page sizes, you can use the options above the Range field to select all pages of the same size. (See [Printing documents with multiple page sizes.](#))

Sequence Choose All Pages to print all pages of a document. Choose Even Pages Only or Odd Pages Only to print only those pages within the specified range. These options are unavailable when you are using the Spreads or Print Master Pages options.

Spreads Prints pages together, as if they were bound, or printed on the same sheet. You can print only one spread per sheet. If the new page is larger than the currently selected paper size, InDesign prints as much as it can, but won't automatically scale the page to fit the *imageable* area, unless you select Scale To Fit in the Setup area of the Print dialog box. You may also want to specify landscape orientation.

Note: *If different trapping styles are applied to pages in the spread, InDesign resolves the differences.*

Print Master Pages Prints all master pages, rather than document pages. Selecting this option makes the Ranges option unavailable.

Examples of page ranges

Page range	Pages printed
11-	Page 11 to the last page of the document.
-11	All pages up to and including page 11.
+11	Page 11 only.
-+11	All pages up to and including page 11.
+11-	All pages from the eleventh page to the end of document.
1, 3-8,	Page 1, plus pages 3 to 8.
+1, +3-+8,	Page 1, plus pages 3 to 8.
Sec1	All pages in section labeled "Sec1".
Sec2:7	Page numbered 7 (not necessarily the seventh page of that section) in section labeled "Sec2."
PartB:7-	Page numbered 7 in section labeled "PartB" to last page of section.
Chap2:7-Chap3	Page 7 in section labeled "Chap2" to end of section labeled "Chap3".
Sec4:3-Sec4:6, Sec3:7	Pages 3–6 in "Sec4" and page 7 in "Sec3".

Options for printing objects

The General area of the Print dialog box contains options for printing elements usually visible only on-screen, such as grids and guides. Choose from the following options:

Print Layers Determine which layers are printed. (See [Choose which layers are printed or exported to PDF.](#))

Print Non-printing Objects Prints all objects, regardless of your settings to selectively prevent individual objects from printing.

Print Blank Pages Prints all pages in the specified page range, even if no text or objects appear on a page. This option is unavailable when you are printing separations. If you are using Print Booklet for composite printing, use the Print Blank Printer Spreads option to print blank spreads added to fill out composite signatures.

Print Visible Guides and Baseline Grids Prints visible guides and grids in the same color as shown in the document. You can control which guides and grids are visible in the View menu. This option is unavailable when you are printing separations.

[To the top](#)

Printing documents with multiple page sizes

You may want to print pages that have different sizes separately. An option in the Print dialog box makes it easy to specify a range that selects all the pages of the same size in the document.

Before you submit a document with multiple page sizes for printing, ask the print provider about special requirements. If you have difficulties printing a document with multiple page sizes, consider dividing it into separate documents.

1. Choose File > Print.
2. In the General panel, select or deselect Spreads to determine whether pages or spreads are printed.
If a spread includes pages of different sizes, the largest width and height on the spread determines the spread size.
3. To print only pages of the same size, use the options above the Range field to select one of the pages or spreads, and then click the pages icon .
The Range field displays all the pages or spreads of that size.
4. After printing a range of one page size, repeat the steps to print other page sizes.

[To the top](#)

Specifying pages to print

You can specify a page range using either absolute numbering (the page's position in the current document) or page/section numbering (the section and page numbers assigned to the page). By default, dialog boxes in InDesign honor the format specified for Page Numbering in the Preferences dialog box.

- When Absolute Numbering is selected, numbers you specify for pages or page ranges correspond to the absolute position of pages in your document. For example, to print the third page in the document, you would enter “3” for Range in the Print dialog box.
- When Section Numbering is selected in the Preferences dialog box, you can enter pages and page ranges exactly as they appear in your layout or using absolute numbering. For example, if the page labeled SecA:5 is the fifteenth page in your document, you could print it by entering “SecA:5” in the Print dialog box or by entering “+15”. The “+” sign indicates that you want to override the normal section and page numbering to use absolute page numbering.

 *If you are unsure which format to use when entering page numbers in the Print dialog box, imitate the format used in the page box at the bottom of the document window.*

[To the top](#)

Specify paper size and page orientation

It's important to distinguish between *page size* (as defined in the Document Setup dialog box for your document) and *paper size* (the sheet of paper, piece of film, or area of the printing plate you'll print on). Your page size might be US Letter (8.5-by-11 inches), but you might need to print

on a larger piece of paper or film to accommodate any printer's marks or the bleed and slug areas.

The list of paper sizes available to InDesign comes from the PPD (PostScript printers) or from the printer driver (non-PostScript printers). If the printer and PPD you've chosen for PostScript printing support custom paper sizes, you'll see a Custom option in the Paper Size menu.

Most imagesetters can accommodate regular paper sizes, such as letter and tabloid, as well as transverse orientation, where the regular page size is rotated 90° when printed. The transverse orientation is often a more efficient use of imagesetter media.

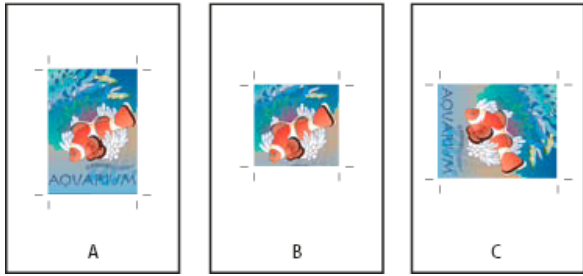

Page size and orientations for imagesetters

A. Letter (tall orientation) **B.** Custom page size (tall orientation) **C.** Letter (transverse orientation)

Paper sizes are listed by familiar names (such as Letter). The dimensions define the limits of the imageable area—the total paper size, less any unprintable border used by the printer or imagesetter. Most laser printers cannot print to the exact edge of a page.

If you select a different paper size (for example, if you change from Letter to Legal), the document is rescaled in the preview window. The preview window displays the entire imageable area of the selected page; when the preview size is changed, the preview window automatically rescales to include the imageable area.

Note: The imageable area will vary by PPD file, even for the same paper size (for example, Letter), because different printers and imagesetters define the sizes of their imageable areas differently.

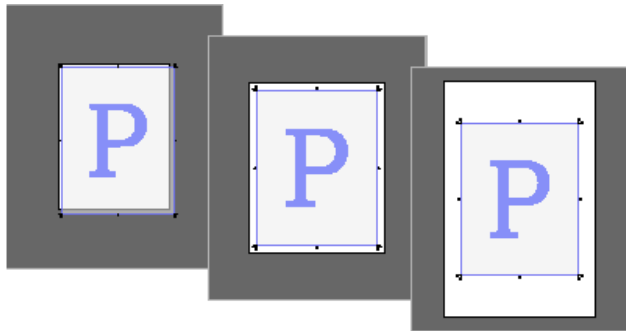

Comparison of printing a letter-size page on Letter, Letter.extra, or Tabloid paper

Note: The preview in the lower-left area of the Print dialog box indicates whether you have enough space to include all printer's marks and the bleed and slug areas.

Specify paper size and orientation

1. Choose File > Print.
2. In the Setup area of the Print dialog box, choose an option in the Paper Size menu.

Make sure that your paper size is large enough to contain your document, the bleed and slug areas (if included), and any printer's marks. To conserve imagesetter film or paper, however, select the smallest paper size that will accommodate your document and the necessary printing information.

3. Click an Orientation button to rotate the document on the media.

In most cases, the page orientation specified in Document Setup (File > Document Setup) and the output orientation specified in the Setup area of the Print dialog box should be the same (both portrait or both landscape), whether you print normal or transverse. If you're printing spreads, you may want to choose a different paper size and orientation (such as landscape) to fit all pages of a spread on a single sheet. If you've rotated the spread view, you may want to change the orientation to print the spread properly.

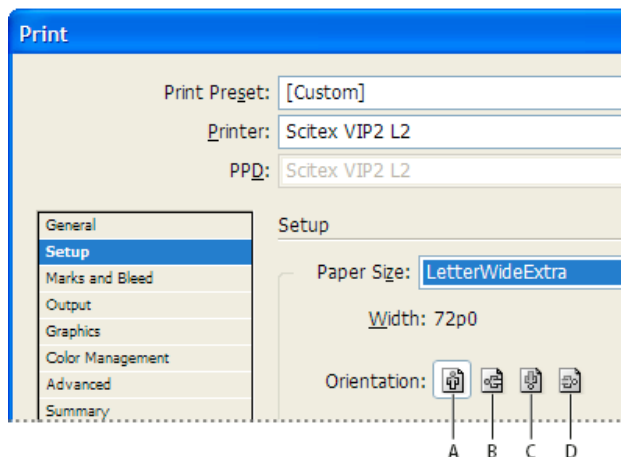

Orientation buttons

A. Portrait B. Landscape C. Reverse Portrait D. Reverse Landscape

Specify a custom paper size

If you're using a printer that accommodates various paper sizes, such as a high-resolution imagesetter, you can specify a custom paper size when you print. InDesign makes the custom option available only if the selected PPD supports custom paper sizes.

The largest custom paper size you can specify depends on the maximum imageable area of your imagesetter. For more information, consult the documentation for your specific printer.

Note: Custom paper size options for non-PostScript printers is not accessible from the InDesign Print dialog box. To set those printer-specific features, click Setup (Windows), Printer (Mac OS), or Page Setup (Mac OS) in the InDesign Print dialog box. Check the documentation for your non-PostScript printer driver for details.

1. Choose File > Print.
2. If you are printing a PostScript file, choose PostScript for Printer in the General area of the Print dialog box. Then select the PPD that supports custom paper sizes.
3. In the Setup area of the Print dialog box, choose Custom in the Paper Size menu.

Note: If Custom is not available, the PPD you selected when you set up your printer does not support custom paper sizes.

4. To specify width and height, do one of the following:
 - To let InDesign determine the smallest paper size needed for your document's contents, bleed and/or slug areas, and any printer's marks, select Auto for Width and Height. Auto, the default option, is also useful if you have different sized pages in a book and you're printing on continuous media, such as a roll of film or photosensitive paper.
 - To specify a paper size larger than the default, enter new dimensions in the Width and Height text boxes. Be sure to increase the values; decreasing the default values may clip your document.
5. To change the placement of the page on the film, enter a value for Offset.

The Offset value specifies the amount of space along the left side of the imageable area. For example, entering a value of 30 points in the Offset option shifts your page 30 points to the right.

- To rotate both media and page contents, select Transverse and click OK.

You can conserve a considerable amount of film or paper by using Transverse in conjunction with Offset. Compare the following examples of an image printed by InDesign with Transverse selected and deselected.

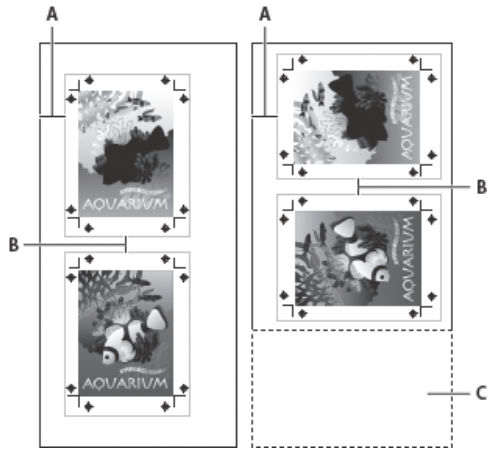

Transverse deselected (left) compared to Transverse selected (right)
A. Offset value **B.** Gap **C.** Film saved

- To specify the distance between individual pages when printing on continuous media, enter a value for Gap.

[To the top](#)

Choose which layers are printed or exported to PDF

- To review or change the Show Layer and Print Layer settings for your document, select a layer in the Layers panel, and then choose Layer Options from the panel menu. Specify layer options, and click OK.
- Do one of the following:
 - Choose File > Print, and click General on the left side of the Print dialog box.
 - Choose File > Export, specify Adobe PDF, and then click Save. On the left side of the Export Adobe PDF dialog box, select General.
- From the Print Layers or Export Layers menu, choose which layers you want to print or include in the PDF:

All Layers Prints or outputs all layers in your document, even if they are hidden or set as nonprinting.

Visible Layers Prints or outputs all visible layers, even if they are set as nonprinting in Layer Options.

Visible & Printable Layers Prints or outputs only those layers that are set as both visible and printable.

[To the top](#)

Printing to non-PostScript language printers

You can print a document on a non-PostScript language printer. However, because PostScript is the standard page-description language for professional publishing, many high-end color and graphics features, such as screen frequencies or color separations, cannot be reproduced on non-PostScript printers. Most imported graphics file formats print acceptably. In general, a document printed to a non-PostScript printer should look the way it appears on-screen when you view the document using Preview Mode.

 *Some vendors sell software programs that add PostScript-language capability to a non-PostScript language printer. Check with your software reseller for availability and compatibility.*

[To the top](#)

Print as bitmap

When you print to a non-PostScript printer, you can choose to rasterize all artwork during printing. This option is useful when printing documents that contain complex objects (such as objects with smooth shading or gradients) because it reduces the possibility of errors.

1. Choose File > Print.
2. Select Advanced on the left side of the Print dialog box.
3. Select Print As Bitmap.

This option is available only if the printer driver identifies the printer as non-PostScript. If this option is selected for non-PostScript printers in Mac OS 10.3 or later, InDesign prints PostScript, which is then used by Mac OS and the driver to render the page images. In Windows, the high-end color and graphics features may not be converted appropriately if this option is not selected.

4. Specify a resolution for bitmap printing.

The output resolution may be limited by the printer driver's resolution. To get the best quality output, set the non-PostScript printer driver resolution to be equal or greater than the output resolution specified in the InDesign Print dialog box.

[To the top](#)

Preview documents

You can view how the document's pages fit on the chosen paper size before you print to a PostScript printer. A preview in the lower-left area of the Print dialog box shows whether your paper and orientation settings will work for your page size. When you select different options in the Print dialog box, the preview updates dynamically with the combined effects of your print settings.

1. Choose File > Print.
2. Click the preview image in the lower-left area of the Print dialog box.

The preview has three views:



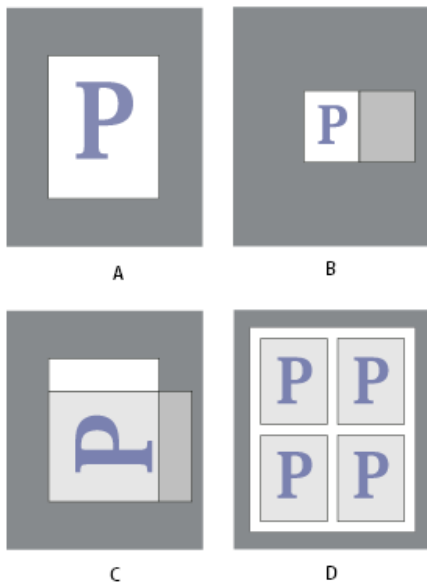

Standard view Displays the relationship of a document page to the media. It shows the effects of various options such as paper size to imageable area, bleed and slug areas, and page marks, as well as the effects of tiling and thumbnails.



Four different page-fit settings in Standard view
A. Default **B.** Spreads **C.** Orientation **D.** 2-by-2 Thumbnails

Text view Lists the numerical values for certain print settings.

Custom page/Cut sheet views Displays the effects of different print settings, depending on your page size. For custom page sizes, the preview shows how the media fits on the custom output device; the maximum supported media dimensions of the output device; and the settings for offset, gap, and transverse. For cut sheets, such as Letter and Tabloid, the preview shows the relationship of the imageable area to the media size.

In both the custom page and cut sheet views, the preview also indicates the output mode using an icon: Separations , Composite Grayscale , Composite CMYK , or Composite RGB .

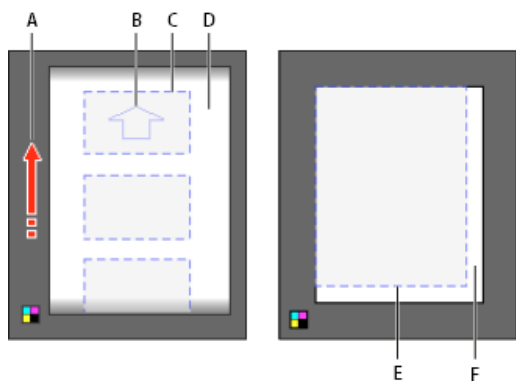

Custom page view (left) and cut sheet view (right)
A. Direction of media travel **B.** Transverse deselected **C.** Paper size **D.** Media **E.** Imageable area **F.** Media

[To the top](#)

Setting up a printer

InDesign supports printing to both PostScript® (Level 2 and 3) and non-PostScript language printers, using most current printer drivers. When you print to a PostScript printer, InDesign uses information from a PostScript Printer Description (PPD) file to determine which settings to display in the Print dialog box.

Follow these basic steps when setting up a printer:

- Install the latest printer driver for your output device. See your operating system documentation for instructions.

- For PostScript printing, select a PPD file when you set up your printer.

About printer drivers

A printer driver lets you directly access printer features from applications on your computer. Having the correct driver ensures that you have access to all of the features a particular printer supports.

Adobe recommends upgrading to the latest driver for your operating system.

Accessing printer driver features

Printer drivers may support features that are not included in InDesign, such as duplex printing. Support for these features varies depending on the printer driver you have. Check with your printer manufacturer for details.

If you want to specify settings for a specific printer, InDesign provides access to the printer driver through the following buttons in the InDesign Print dialog box. (When you choose to print to a PostScript file, these options are not available.)

Setup (Windows) This button opens the Windows Print dialog box.

Page Setup (Mac OS) This button displays the standard Mac OS Page Setup dialog box.

Printer (Mac OS) This button displays the standard Mac OS Print dialog box.

Note: Some InDesign printing features appear in both the printer driver dialog boxes and the InDesign Print dialog box. For best results, specify the settings in the InDesign Print dialog box only. If settings overlap, InDesign tries to synchronize the settings, or to ignore the driver's settings. Some printer driver features (for example, N-up printing, which prints the same artwork multiple times on the same page) produce adverse printing results when used with InDesign features such as separations.

Select a PPD file

A *PPD file* (PostScript Printer Description file) customizes the behavior of the driver for your specific PostScript printer. It contains information about the output device, including printer-resident fonts, available media sizes and orientation, optimized screen frequencies, screen angles, resolution, and color output capabilities. It's important to set up the correct PPD before you print. Selecting the PPD that corresponds to your PostScript printer or imagesetter populates the Print dialog box with the available settings for the output device. You can switch to a different one to suit your needs. Applications use the information in the PPD file to determine which PostScript information to send to the printer when printing a document.

For best printing results, Adobe recommends that you obtain the latest version of the PPD file for your output device from the manufacturer. Many print service providers and commercial printers have PPDs for the imagesetters they use. Be sure to store PPDs in the location specified by the operating system. For details, consult the documentation for your operating system.

- In Windows and in Mac OS, you select a PPD file in the same way you add a printer. The steps for selecting a PPD file are different for each platform. See your operating system documentation for details.

[To the top](#)

Use print presets

If you regularly output to different printers or job types, you can automate print jobs by saving all output settings as print presets. Using print presets is a fast, reliable way to print jobs that require consistently accurate settings for many options in the Print dialog box.

You can save and load print presets, making it easy to back them up or to make them available to your service providers, clients, or others in your workgroup.

You can create and review print presets in the Print Presets dialog box.

Create print presets

- Do one of the following:
 - Choose File > Print, adjust print settings, and click Save Preset. Type a name or use the default, and then click OK. With this method, the preset is saved in the preferences file.
 - Choose File > Print Presets > Define, and then click New. In the dialog box that appears, type a new name or use the default, adjust print settings, and then click OK to return to the Print Presets dialog box. Then click OK again.

Apply print presets

1. Choose File > Print.
2. Choose a print preset from the Print Preset menu. If you like, confirm the printer settings in the Print dialog box.
3. Click Print.

Note: In InDesign, you can also print using a print preset by choosing one from the File > Print Presets menu.

Edit print presets

- Do one of the following:
 - Choose File > Print, adjust print settings, and click Save Preset. In the Save Preset dialog box that appears, either type a name in the text box or use the current name. (If the current name is an existing preset, saving overwrites that preset's settings.) Click OK.
 - Choose File > Print Presets > Define, select a preset from the list, and then click Edit. Adjust print settings, and click OK to return to the Print Presets dialog box. Then click OK again.

 You can edit the default preset as you would any other using the steps outlined above.

Delete print presets

1. Choose File > Print Presets > Define.
2. Select one or more presets from the list and click Delete. Shift-click to select adjacent presets. Ctrl-click (Windows) or Command-click (Mac OS) to select nonadjacent presets.

Adobe also recommends

- [Adobe Print Resource Center](#)
- Export to PDF for printing
- Export to PDF for printing

 Twitter™ and Facebook posts are not covered under the terms of Creative Commons.

[Legal Notices](#) | [Online Privacy Policy](#)

Printing booklets

[Impose a document for booklet printing](#)

[Understanding creep](#)

[Preview or view a summary of booklet printing](#)

[Troubleshooting booklet printing](#)

[To the top](#)

Impose a document for booklet printing

The Print Booklet feature lets you create *printer spreads* for professional printing. For example, if you're editing an 8-page booklet, the pages appear in sequential order in the layout window. However, in printer spreads, page 2 is positioned next to page 7, so that when the two pages are printed on the same sheet, folded, and collated, the pages end up in the appropriate order.

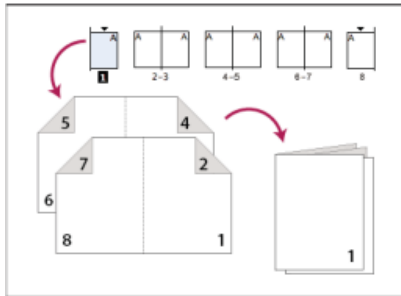

Pages appear in sequence in the layout window, but are printed in a different order so that they appear correct when folded and bound.

The process of creating printer spreads from layout spreads is called *imposition*. While imposing pages, you can change settings to adjust spacing between pages, margins, bleed, and creep. The layout of your InDesign document is not affected, because the imposition is all handled in the print stream. No pages are shuffled or rotated in the document.

Jeff Witchel from [Infiniteskills.com](#) demonstrates [Printing booklets from your desktop printer](#).

Note: *You cannot create a new document based on the imposed pages. In addition, if your document includes multiple page sizes, you cannot use Print Booklet to impose a document.*

1. Choose File > Print Booklet.
2. If a printer preset has the settings you want, choose it in the Print Preset menu.

To use the print settings (as they appear in the Print dialog box) of the current document, choose Current Document Settings from the Print Preset menu.

3. If you don't want the entire document to be imposed, select Range in the Setup area and specify which pages to include in the imposition.

Use hyphens to separate consecutive page numbers, and commas for nonadjacent page numbers. For example, typing 3-7, 16 imposes pages 3 through 7 and 16.

Note: *If you have divided the document into sections of page numbers, you should enter section page numbers (such as Sec2:11) in the Range field.*

4. To change settings such as printer's marks and color output, click Print Settings. Using the options on the left, change settings as needed, and then click OK.

5. In the Print Booklet dialog box, specify other booklet setup options as appropriate, and then click Print.

Note: The number of pages in a booklet is always a multiple of four. If you are printing to a PDF printer, blank pages are inserted in the PDF to create the booklet.

Booklet types

You can choose three types of imposition: 2-up Saddle Stitch, 2-up Perfect Bound, and Consecutive.

2-up Saddle Stitch Creates two-page, side-by-side printer spreads. These printer spreads are appropriate for printing on both sides, collating, folding, and stapling. InDesign adds blank pages as needed to the end of the finished document. The Space Between Pages, Bleed Between Pages, and Signature Size options are dimmed when 2-up Saddle Stitch is selected.

Print Booklet imposes pages based on the Binding setting. If the document has a Right to Left Binding setting, Print Booklet will impose pages accordingly. Choose File > Document Setup to view the document's Binding setting.

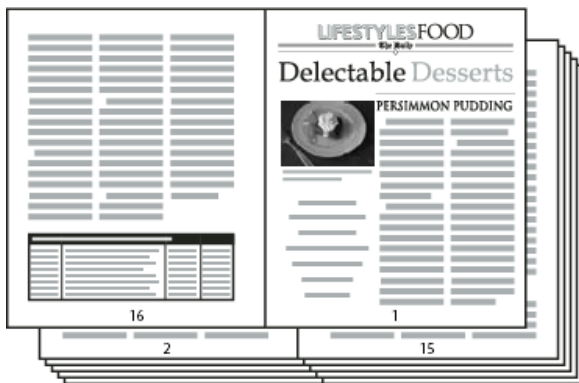

Creating printer spreads for a 24-page black-and-white newsletter using the 2-up Saddle Stitch style yields 12 spreads.

2-up Perfect Bound Creates two-page, side-by-side printer spreads that fit within the specified signature size. These printer spreads are appropriate for printing on both sides, cutting, and binding to a cover with adhesive. If the number of pages to be imposed is not evenly divisible by the signature size, InDesign adds blank pages as needed to the back of the finished document.

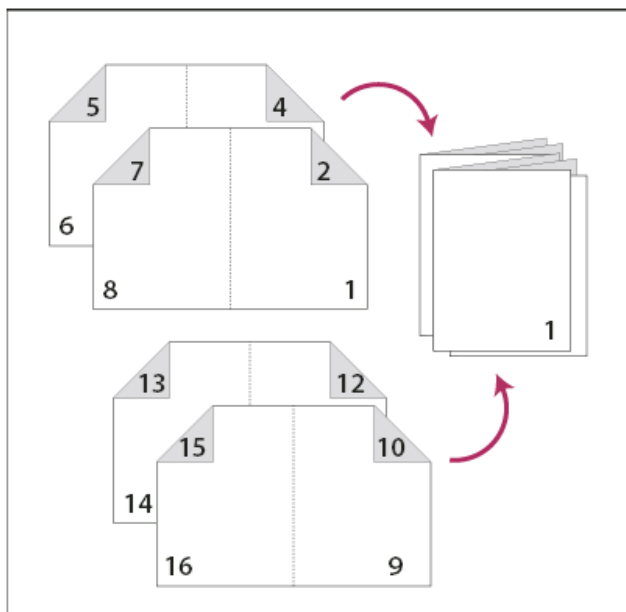

2-up Perfect Bound divided in four signatures

If a booklet has a color cover and black-and-white insides, you can create two separate impositions from the same document: one for the front cover, inside front cover, inside back cover, and back cover; and one for the 24 pages inside the booklet. To produce the color signature, click Range in the Pages area of the Setup area, and type **1-2, 27-28** (or whatever the section page numbers are). To produce the black-and-white insides, type **3-26** in the Range text box.

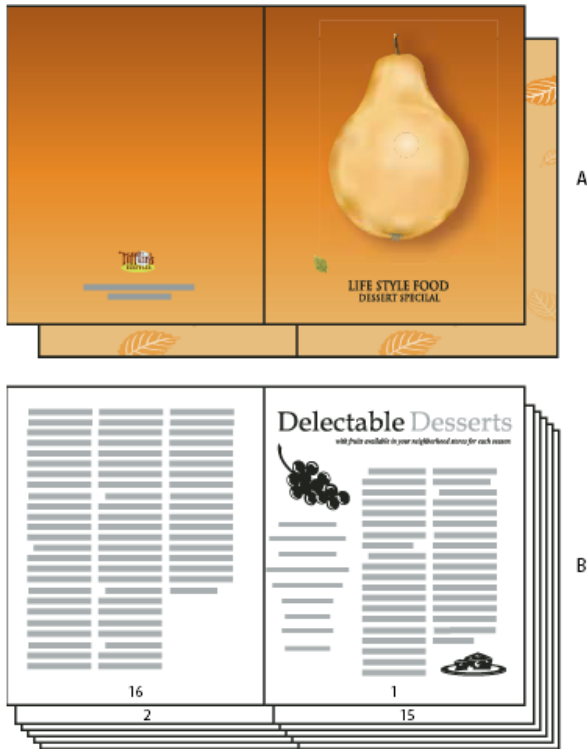

28-page booklet with a color cover

A. Color signature for cover **B.** Black-and-white inside page

Consecutive Creates a two-, three-, or four-page panel appropriate for a foldout booklet or brochure. The Bleed Between Pages, Creep, and Signature Size are dimmed when a Consecutive option is selected.

For example, if you want to create printer spreads for a traditional six-panel, trifold brochure, choose 3-up Consecutive. You may be accustomed to setting up trifolds as one page with three different columns. With InDesign imposition, you can simply create pages that are the size of each panel.



3-Up Consecutive

Spacing, bleed, and margin options for booklet printing

You can change the following options in the Setup area of the Print Booklet dialog box.

Space Between Pages Specifies the gap between pages (the right side of the left page and the left side of the right page). You can specify a Space Between Pages value for all the booklet types except Saddle Stitch.

For Perfect Bound documents, if you are creeping in (with a negative value), the minimum Space Between Pages value is the width of the Creep value. If you're manually creating signatures (for example, if there are different stocks in the same document), you can enter a Space Between Pages value to specify a starting creep for spreads that belong to different signatures.

Bleed Between Pages Specifies the amount of space used to allow page elements to encroach the gap in Perfect Bound printer spread styles. This option is sometimes referred to as *crossover*.) The field accepts values between 0 and half the Space Between Pages value. You can specify this option only when 2-up Perfect Bound is selected.

Creep Specifies the amount of space necessary to accommodate paper thickness and folding on each signature. In most cases, you'll want to specify a negative value to create a push-in effect. You can specify Creep for 2-up Saddle Stitch and 2-up Perfect Bound booklet types. (See [Understanding creep](#).)

Signature Size Specifies the number of pages in each signature for 2-up Perfect Bound documents. If the number of pages to be imposed is not evenly divisible by the Signature Size value, blank pages are added to the end of the document as necessary.

Automatically Adjust To Fit Marks And Bleeds Lets InDesign calculate the margins to accommodate the bleeds and the other printer mark options currently set. The fields under Margins are dimmed when this option is selected, but they reflect the actual values that will be used to fit marks and bleeds. If you deselect this option, you can adjust the margin values manually.

Margins Specifies the amount of space that surrounds the actual printer spread after trimming. To specify individual values for Top, Bottom, Left, and Right, deselect Automatically Adjust To Fit Marks And Bleeds, and increase the values to insert extra space beyond the default marks and bleeds. (Decreasing the values may result in clipping the marks and bleeds.) You can specify margin values for all booklet printing types.

Print Blank Printer Spreads If the number of pages to be imposed is not evenly divisible by the Signature Size value, blank pages or spreads are added to the end of the document. Use this option to determine whether those blank spreads at the end of the document are printed. Note that printing other blank pages in the document is controlled by the Print Blank Pages option in the Print dialog box.

[To the top](#)

Understanding creep

Creep specifies the distance pages move from the spine to accommodate paper thickness and folding in Saddle Stitch and Perfect Bound documents. InDesign considers the "cover" of the final piece to be the outermost printer spread, while the "centerfold" is considered to be the innermost printer spread. The term *sheet* represents two printer spreads: the front of the sheet and the back of the sheet. The *creep increment* is calculated by dividing the specified creep value by the total number of sheets minus one.

When you provide a positive creep value, the centerfold is not adjusted, but the pages on the outer sheets move away from the spine. When you provide a negative creep, the cover is not adjusted, but the pages on the inner sheets move towards the spine.

For example, a 16-page InDesign document could yield eight printer spreads, or four sheets. The front of the first sheet will consist of the first printer spread (pages 16 and 1) while the back of the first sheet will consist of the second printer spread (pages 2 and 15).

If the creep value in this example is 24 points (an exaggerated amount for the sake of clarity), the creep increment is 8 points per sheet (24 divided by 3). The amount of creep applied to the innermost sheet is 24 points, the amount of creep applied to the third sheet is 16 points, and the amount of creep applied to the second sheet is 8 points. No creep will be applied to the first outermost sheet.

The amount of creep for each successive sheet is decreased by the creep increment. In summary, each page on the innermost sheet is moved 12 points (half of the 24-point creep value for this sheet) away from the spine, each page on the third sheet is moved 8 points (half of the 16-point creep value for this sheet) away from the spine, and each page on the second sheet is moved 4 points (half of the 8-point creep value for this sheet) away from the spine.

[To the top](#)

Preview or view a summary of booklet printing

The Preview area of the Print Booklet dialog box lets you review color thumbnails of the printer spreads created by your selected imposition style. You can also see the printer's marks you've specified in the Print dialog box.

1. Choose File > Print Booklet.

2. Do any of the following:

- Click Preview on the left side of the dialog box. To flip through the printer spreads, click the scroll arrows. Click the left scroll arrow to go backwards from spread to spread. You can also drag the scroll box to change printer spreads.
- Click Summary on the left side of the Print Booklet dialog box to view a summary of current booklet settings. Check the bottom of the Summary area for any conflicting settings.

 If you click *Print Settings* and change the settings in the *Print dialog box*, you can observe the effect of the modified settings in the *Preview area*.

[To the top](#)

Troubleshooting booklet printing

Note these issues to address when printing booklets.

Can't create new document Unfortunately, you can't create a new InDesign document with the imposed pages. You can print the imposed document or create a PDF.

Blank pages not included You may add blank pages in the middle of a document to make sure there are enough pages for each printer spread. However, if these pages contain no text or objects, they may not be recognized, and additional blank pages are added at the end of the document. To make sure that the blank pages you added are included in the imposed document, click *Print Settings* in the *Print Booklet dialog box*, and then select *Print Blank Pages* and click *OK*.

Printing double-sided pages without a duplex printer Use the *Odd Pages Only* and *Even Pages Only* options in either *Adobe Acrobat* or *InDesign*. After one set is printed, flip over the pages, load it in the printer, and print the rest of the pages. For best results, print a test document to see which direction and order the pages should be added to the printer.

 Twitter™ and Facebook posts are not covered under the terms of Creative Commons.

[Legal Notices](#) | [Online Privacy Policy](#)

Printer's marks and bleeds

- Specify printer's marks
- Print the bleed or slug areas
- Change the page position on the media

[To the top](#)

Specify printer's marks

When you prepare a document for printing, a number of marks are needed to help the printer determine where to trim the paper, align separation films when producing proofs, measure film for correct calibration and dot density, and so on. Selecting any page-mark option expands the page boundaries to accommodate printer's marks, *bleed* (the parts of text or objects that extend past the page boundary to account for slight inaccuracy when trimming), or *slug area* (an area outside the page and bleed that contains printer instructions or job sign-off information).

If you are setting crop marks and want the artwork to contain a bleed or slug area, make sure that you extend the artwork past the crop marks to accommodate the bleed or slug. Also make sure that your media size is large enough to contain the page and any printer's marks, bleeds, or the slug area. If a document doesn't fit the media, you can control where items are clipped by using the Page Position option in the Setup area of the Print dialog box.

If you select the Crop Marks option, fold marks are printed as solid lines when spreads are printed.



Printer's marks

A. Crop marks **B.** Registration mark **C.** Page information **D.** Color bars **E.** Bleed marks **F.** Slug area

1. Choose File > Print.
2. Click Marks and Bleed on the left side of the Print dialog box.
3. Select either All Printer's Marks or individual marks.

[To the top](#)

Print the bleed or slug areas

Specify the bleed and slug areas in the Document Setup dialog box. The bleed and slug areas are discarded when the document is trimmed to its final page size. Objects outside the bleed or slug area (whichever extends farthest) are not printed.

When printing, you can override the default location for bleed marks in the Bleed And Slug area of the Marks And Bleed area.

Files saved in PostScript file format allow capable post-processing programs to implement their own variable bleed.

1. Choose File > Print.
2. Click Marks And Bleed on the left side of the Print dialog box.
3. Select either All Printer's Marks or individual marks.
4. To override bleed settings in the Document Setup dialog box, uncheck Use Document Bleed Settings and enter values from 0 to 6 inches (or equivalents) for Top, Bottom, Left, and Right (for single-sided documents), or Top, Bottom, Inside, and Outside (for double-sided documents with facing pages). To extend the offset evenly on all sides of the page, click the Make All Settings The Same icon .
5. Click Include Slug Area to print objects using the slug area defined in the Document Setup dialog box.

 You can preview the bleed and slug areas before printing by clicking the Bleed Preview Mode or the Slug Preview Mode icon at the bottom of the Toolbox. (These may be hidden by the Preview Mode icon.)

Marks and Bleed options

The Marks And Bleed area includes the following options:

All Printer's Marks Selects all printer's marks including crop marks, bleed marks, registration marks, color bars, and page information.

Crop Marks Adds fine (hairline) horizontal and vertical rules that define where the page should be trimmed. Crop marks can also help register (align) one color separation to another. By using together with bleed marks, you can select overlapped marks.

Bleed Marks Adds fine (hairline) rules that define the amount of extra area to image outside the defined page size.

Registration Marks Adds small "targets" outside the page area for aligning the different separations in a color document.

Color Bars Adds small squares of color representing the CMYK inks and tints of gray (in 10% increments). Your service provider uses these marks to adjust ink density on the printing press.

Page Information Prints the filename, page number, current date and time, and color separation name in 6-point Helvetica in the lower-left corner of each sheet of paper or film. The Page Information option requires 0.5 inches (13mm) along the horizontal edge.

Please note that page information is printed in GothicBBB-Medium-83pv-RKSJ-H (Medium Gothic) font.

Type Lets you choose default printer's marks or custom marks (for Japanese pages, for example). You can create custom printer's marks or use custom marks created by another company.

Weight Displays possible weights for crop and bleed mark lines.

Offset Specifies how far from the edge of the page (not the bleed) InDesign will draw printer's marks. By default, InDesign draws printer's marks 6 points from the edge of the page. To avoid drawing printer's marks on a bleed, be sure to enter an Offset value greater than the Bleed value.

[To the top](#)

Change the page position on the media

When you print a document to a cut-sheet media size that is larger than the document size, you can control where the slug and bleed areas, printer's marks, and page fall on the media by using the Page Position options in the Setup area of the Print dialog box. If a document doesn't fit the media and needs to be clipped, you can specify which part of the document is clipped. The preview image in the Print dialog box shows the results.

Note: To see the bleed and slug areas and printer's marks, use the Scale To Fit option instead of Page Position; scaled pages are always centered. The Page Position options are unavailable when Scale To Fit, Thumbnails, or Tile is selected.

- In the Setup area of the Print dialog box, choose a position in the Page Position menu.

Adobe also recommends

 Twitter™ and Facebook posts are not covered under the terms of Creative Commons.

[Legal Notices](#) | [Online Privacy Policy](#)

Trap presets

- [Trap Presets panel overview](#)
- [Create or modify a trap preset](#)
- [Manage trap presets](#)
- [Assign a trap preset to pages](#)
- [Set up trapping page ranges](#)
- [Trap preset options](#)
- [Set sliding traps](#)
- [About trapping black](#)
- [Set the trap width for colors next to black](#)
- [Printing books with conflicting trap presets](#)

[To the top](#)

Trap Presets panel overview

A *trap preset* is a collection of trapping settings you can apply to a page or range of pages in a document. The Trap Presets panel provides an interface for entering trap settings and saving trap presets. You can apply trap presets to any or all pages in the current document, or import the presets from another InDesign document. If you don't apply a trap preset to a trapping page range, that page range will use the [Default] trap preset.

View trap preset settings

1. If the Trap Presets panel is not open, choose Window > Output > Trap Presets.
2. Do one of the following in the Trap Presets panel:
 - Double-click the preset.
 - Select the preset and choose Preset Options in the panel menu.

Compress the trap presets list

- In the Trap Presets panel, choose Small Panel Rows in the panel menu.

Identify unused trap presets

- In the Trap Presets panel, choose Select All Unused in the panel menu. The trapping engine highlights all presets (except [Default] and [No Trap Preset]) that have not been assigned to the current document. You can easily delete these presets.

[To the top](#)

Create or modify a trap preset

1. If the Trap Presets panel is not open, choose Window > Output > Trap Presets.
2. Choose New Preset in the panel menu to create a preset, or double-click a preset to edit it.

Note: Clicking the New Preset button at the bottom of the Trap Presets panel creates a preset based on the [Default] trap preset settings.

3. Specify the following options, and then click OK:

Name Type a name for the preset. You can't change the name of the [Default] trap preset.

Trap Width Type values to specify the amount of overlap for inks.

Trap Appearance Specify options for controlling the shape of the traps.

Image Specify settings that determine how to trap imported bitmap images.

Trap Thresholds Type values to specify the conditions under which trapping occurs. Many variables affect the values you'll need to enter here. For more information, consult with your prepress service provider.

[To the top](#)

Manage trap presets

You can duplicate, delete, import, and customize trap presets.

Duplicate a trap preset

- Do one of the following:
 - In the Trap Presets panel, select a preset and choose Duplicate Preset in the panel menu.
 - Drag a preset to the New Preset button at the bottom of the panel.

Delete a trap preset

1. In the Trap Presets panel, select the preset(s), and then do one of the following:
 - Click the Delete button.
 - Choose Delete Presets in the panel menu.
2. If prompted to replace a trap preset, choose one in the Delete Trap Preset dialog box that appears. This dialog box appears if at least one of the selected presets has been assigned to a page.
3. Click Yes to confirm the deletion.

Note: You cannot delete either of the two built-in presets: [Default] and [No Trap Preset].

Import presets from another InDesign document

1. In the Trap Presets panel, choose Load Trap Presets in the panel menu.

2. Select the InDesign file and click Open.

[To the top](#)

Assign a trap preset to pages

You can assign a trap preset to a document or to a range of pages in a document. Pages with no abutting colors will print faster if you disable trapping on those pages. Trapping doesn't actually occur until you print the document.

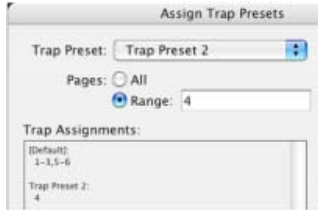

Trap assignments list the presets you have applied to various pages; the trap assignments are updated each time you click Assign.

1. In the Trap Presets panel, choose Assign Trap Preset in the panel menu.
2. For Trap Preset, choose the preset you want to apply.
3. Select the pages to which you want to apply the trap preset.
4. Click Assign, and then click Done.

Note: *If you click Done without clicking Assign, the dialog box closes without making any changes to the trap assignments. Trap assignments previously made using the Assign button are preserved.*

[To the top](#)

Set up trapping page ranges

1. In the Trap Presets panel, choose Assign Trap Preset in the panel menu.
2. For Trap Preset, choose the preset you want to apply to the page ranges.
3. Select Range, and type one or more ranges in ascending sequence, using a hyphen for each range, and separating pages and ranges with commas, or with commas and spaces. For example, 2-4, 6, 9-10, 12- is a valid range.
4. Click Assign, and then click Done.

To disable a trapping page range, choose Assign Trap Preset in the panel menu, type a page range, and choose [No Trap Preset] in the Trap Preset menu. Click Assign, and then click Done.

[To the top](#)

Trap preset options

You can change trap preset options whenever you create or edit a trap preset. The same trap preset options are available in Acrobat and InDesign. In Acrobat, you can view trap presets by choosing Tools > Print Production > Trap Presets. In InDesign, choose Window > Output > Trap Presets.

Trap widths

Trap width is the amount of overlap for each trap. Differences in paper characteristics, screen rulings, and printing press conditions require different trap widths. To determine the appropriate trap widths for each job, consult your commercial printer.

Default Specifies the trap width in points for trapping all colors except those involving solid black. The default value is 0p0.25.

Black Indicates the distance that inks spread into solid black, or the *holdback amount*—the distance between black edges and underlying inks for trapping rich blacks. The default value is 0p0.5. This value is often set to be 1.5 to 2 times the value of the default trap width.

In InDesign, the value you set for Black Color determines the value for a solid black or a *rich black*, a process black (K) ink mixed with color inks for increased opacity and richer color.

Note: (InDesign) If you choose *Application Built-In trapping*, and you specify a *Default trap width* or *Black trap width* larger than 4 points, the resulting trap width is limited to 4 points. However, the value you specified will continue to be displayed, because if you switch to *Adobe In-RIP Trapping*, traps larger than 4 points are applied as you specified.

Trap appearance

A *join* is where two trap edges meet at a common endpoint. You can control the shape of the outside join of two trap segments and the intersection of three traps.

Join Style Controls the shape of the outside join of two trap segments. Choose from Miter, Round, and Bevel. The default is Miter, which matches earlier trapping results to retain compatibility with previous versions of the Adobe Trapping Engine.



Trap join examples, left to right: miter join, round join, bevel join

End Style Controls the intersection of three-way traps. Miter (the default) shapes the end of the trap to keep it away from the intersecting object. Overlap affects the shape of the trap generated by the lightest neutral density object that intersects with two or more darker objects. The end of the lightest trap is wrapped around the point where the three objects intersect.

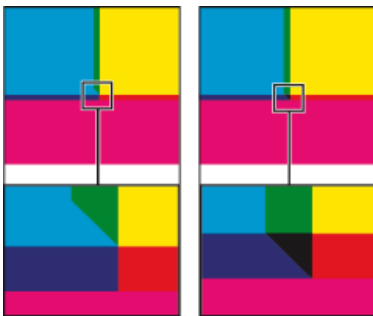

Close-up of trap end examples: miter (left) and overlap (right)

Trap thresholds

Step Specifies the color change threshold at which the trapping engine creates a trap. Some jobs need only the most extreme color changes trapped, while others require traps for more subtle color changes. The Step value indicates the degree to which components (such as CMYK values) of abutting colors must vary before trapping occurs.

To change how much the component inks in abutting colors can vary before causing those colors to trap, increase or decrease the value for Step

in the New Trap Preset or Modify Trap Preset Options dialog box. The default is 10%. For best results, use a value from 8% to 20%. Lower percentages increase sensitivity to color differences and result in more traps.

Black Color Indicates the minimum amount of black ink required before the Black trap width setting is applied. The default value is 100%. For best results, use a value no lower than 70%.

Black Density Indicates the neutral density value at or above which InDesign considers an ink to be black. For example, if you want a dark spot ink to use the Black trap width setting, enter the neutral density value here. This value is typically set near the default of 1.6.

Sliding Trap Determines when the trapping engine starts to straddle the centerline of the color boundary. The value refers to the proportion of the lighter color's neutral density value to a darker, abutting color's neutral density value. For example, setting the Sliding Trap value to 70% moves the point at which the trap begins to straddle the centerline to where the lighter color exceeds 70% of the darker color in neutral density (lighter color's neutral density divided by darker color's neutral density > 0.70). Colors of identical neutral density will always have their traps exactly straddle the centerline, unless the Sliding Trap is set to 100%.

Trap Color Reduction Indicates the degree to which components from abutting colors are used to reduce the trap color. This setting is useful for preventing certain abutting colors (such as pastels) from making an unsightly trap that is darker than either color. Specifying a Trap Color Reduction lower than 100% begins to lighten the color of the trap; a Trap Color Reduction value of 0% makes a trap with a neutral density equal to the neutral density of the darker color.

Trapping imported graphics

You can create a trap preset to control traps within images, and to control traps between bitmap images (such as photographs and those saved in raster PDF files) and vector objects (such as those from a drawing program and vector PDF files). Each trapping engine handles imported graphics differently. It's important to be aware of these differences when setting trapping options.

Trap Placement Provides options for determining where the trap falls when you trap vector objects (including objects drawn in InDesign) to bitmap images. All options except Neutral Density create a visually consistent edge. Center creates a trap that straddles the edge between objects and images. Choke causes objects to overlap the abutting image. Neutral Density applies the same trapping rules as used elsewhere in the document. Trapping an object to a photograph with the Neutral Density setting can result in noticeably uneven edges as the trap moves from one side of the edge to another. Spread causes the bitmap image to overlap the abutting object.

Trap Objects To Images Ensures that vector objects (such as frames used as keylines) trap to images, using the Trap Placement settings. If vector objects don't overlap images in a trapping page range, consider turning this option off to speed trapping of that page range.

Trap Images To Images Turns on trapping along the boundary of overlapping or abutting bitmap images. This feature is on by default.

Trap Images Internally Turns on trapping among colors within each individual bitmap image (not just where they touch vector artwork and text). Use this option only for page ranges containing simple, high-contrast images, such as screen shots or cartoons. Leave it unselected for continuous-tone and other complicated images, as it will create bad traps. Trapping is faster when this option is unselected.

Trap 1-Bit Images Ensures that 1-bit images trap to abutting objects. This option doesn't use the Image Trap Placement settings, because 1-bit images use only one color. In most cases, leave this option selected. In some cases, such as with 1-bit images where pixels are widely spaced, selecting this option may darken the image and slow the trapping.

[To the top](#)

Set sliding traps

1. Choose New Preset in the panel menu to create a preset, or double-click a preset to edit it.
2. In the Trap Thresholds section, for Sliding Trap, enter a percentage from 0 to 100, or use the default of 70%. At 0%, all traps default to centerline; at 100%, sliding traps are turned off, forcing one color to be spread fully into another regardless of the neutral density relationship of the abutting colors.

About trapping black

When creating or editing presets, the value you type for Black Color determines what is considered solid black and rich black. A *rich black* is any black color that uses a *support screen*—additional percentages of one or more process inks to strengthen the black.

The Black Color setting is useful when you must compensate for extreme dot gain (as when using low-grade paper stock). These situations cause black percentages lower than 100% to print as solid areas. By screening back blacks or rich blacks (using tints of solid black) and decreasing the Black Color setting from its default of 100%, you can compensate for dot gain and ensure that the trapping engine will apply the proper trap width and placement to black objects.

When a color reaches the Black Color value, the Black trap width value is applied to all abutting colors, and *keepaway traps* are applied to rich black areas using the Black trap width value.

If support screens extend all the way to the edge of a black area, any misregistration causes the edges of support screens to become visible, creating an unwanted halo or distorting the edges of objects. The trapping engine uses a *keepaway*, or a *holdback*, for rich blacks to keep support screens a specified distance away from edges of reversed-out or light elements in the foreground, so that the light elements retain their sharpness. You control the distance of support screens from the edges of black areas by specifying the Black trap width value.

Note: *If the element you're trapping is a thin element, such as a black keyline around graphics, the trapping engine overrides the Black trap width setting and limits the trap to half the width of the thin element.*

[To the top](#)

Set the trap width for colors next to black

1. Choose New Preset in the panel menu to create a preset, or double-click a preset to edit it.
2. In the Trap Width section, for Black, enter a distance (in points) for how far you want other colors to spread into black, or for how far you want support screens choked back under black. Typically, the Black trap width is set to be 1.5 to 2 times the value of the Default trap width.
3. For Black Color and Black Density, set values.

Note: *To use black trapping features, a color area must use an ink with a neutral density greater than or equal to the Black Density, and the ink must occur in percentages greater than or equal to the Black Color.*

[To the top](#)

Printing books with conflicting trap presets

You can apply one trap preset to one sheet of output, such as one page. Normally this is not a concern. However, if you print multiple documents in a book, and each document or page has a different trap preset, InDesign can resolve some trap preset conflicts by synchronizing presets among documents:

- If documents in a book use different trap presets with the same name, InDesign assigns the trap preset used in the master document, provided you've selected the Trap Preset option in the Synchronize Options dialog box.
- The synchronizing feature makes all the master document's presets available to the other documents in the book, but does not assign them; you have to assign trap presets in each document, or use the [Default] trap preset. The presets appear in the Trap Preset menu of the document's Assign Trap Presets dialog box.

Note: *If different trap presets are applied to pages in a spread, InDesign honors each trap preset.*

Adobe also recommends

 Twitter™ and Facebook posts are not covered under the terms of Creative Commons.

[Legal Notices](#) | [Online Privacy Policy](#)

Trapping documents and books

- [About ink trapping](#)
- [Trapping methods](#)
- [About automatic trapping](#)
- [Automatic trapping requirements](#)
- [Differences between built-in trapping and Adobe In-RIP Trapping](#)
- [Trapping imported bitmap images](#)
- [Trapping imported vector graphics](#)
- [Trapping text](#)
- [Maximizing trapping performance](#)
- [Setting aside disk space for built-in trapping](#)
- [Trap a document or book](#)

[To the top](#)

About ink trapping

When an offset printed document uses more than one ink on the same page, each ink must be printed *in register* (perfectly aligned) with any other inks that it abuts, so that there is no gap where the different inks meet. However, it's impossible to ensure exact registration for every object on every sheet of paper running through a printing press, so *misregistration* of inks can occur. Misregistration causes an unintended gap between inks.

You can compensate for misregistration by slightly expanding one object so that it overlaps an object of a different color—a process known as *trapping*. By default, placing one ink over another *knocks out*, or removes, any inks underneath to prevent unwanted color mixing; but trapping requires that inks *overprint*, or print on top of each other, so that at least a partial overlap is achieved.



Misregistration with no trap (left) and with trap (right)

Most traps employ *spreading*—expanding a light object into a dark object. Because the darker of two adjacent colors defines the visible edge of the object or text, expanding the lighter color slightly into the darker color maintains the visual edge.

[To the top](#)

Trapping methods

Trap a document using any combination of methods, including the following:

- Use process colors that don't need trapping.
- Overprint black.
- Manually overprint strokes or fills.
- Use Adobe InDesign CS4 built-in trapping or Adobe In-RIP Trapping.
- Trap imported graphics using the trapping features in the illustration programs in which they were created. Refer to the documentation for these applications.

Choose a trapping solution that complements the color output workflow you're using, such as Adobe PostScript or PDF.

Avoid the need for trapping by eliminating the possibility of misregistration in your use of color. Prevent misregistration by making sure that abutting process colors have common inks. For example, if you specify a dark purple stroke with a vivid red fill, they will both contain a significant percentage of magenta. The stroke's and fill's common magenta will print as a single area, so that if misregistration occurs in the other process inks, the magenta printing plate will make any resulting gap hard to see.

[To the top](#)

About automatic trapping

InDesign can trap color documents with its built-in trapping engine, and can also take advantage of the Adobe In-RIP Trapping engine available on Adobe PostScript output devices that support Adobe In-RIP Trapping.

Both trapping engines calculate adjustments to the edges of both type and graphics. They apply trapping techniques to different parts of a single object, even if text or an InDesign object overlaps several different background colors. Trapping adjustments are made automatically, and you can define trap presets to address the requirements of specific page ranges. You only see the effects of trapping on color separations generated by a trapping engine; you cannot see the results on-screen within InDesign.

The trapping engine detects contrasting color edges, and then creates traps based on the neutral densities (lightness or darkness) of abutting colors, in most cases by spreading lighter colors into adjacent darker colors. The trapping settings you specify in the Trap Presets panel modify the trapping engine's results.

[To the top](#)

Automatic trapping requirements

To trap documents using the InDesign built-in engine, you need a PPD that supports separations.

To trap documents using the Adobe In-RIP Trapping engine, you need the following software and hardware:

- An Adobe PostScript Level 2 or later output device that uses a RIP that supports Adobe In-RIP Trapping. To find out if a PostScript output device supports Adobe In-RIP Trapping, contact the manufacturer or your prepress service provider.
- A PPD (PostScript Printer Description) file for a printer that supports Adobe In-RIP Trapping. You must select this PPD when you install the printer.

[To the top](#)

Differences between built-in trapping and Adobe In-RIP Trapping

Composite color workflow With built-in trapping, you can separate a document by using InDesign or in-RIP separations. To use Adobe In-RIP Trapping, you must use In-RIP separations.

Trap widths Built-in trapping limits trap widths to 4 points, regardless of the value you enter for the trap widths. For larger trap widths, use Adobe In-RIP Trapping.

Vector EPS graphics Built-in trapping cannot trap placed vector EPS graphics; Adobe In-RIP Trapping traps all imported graphics.

[To the top](#)

Trapping imported bitmap images

Built-in trapping can trap bitmap images, such as photographs, to text and graphics. Bitmap images must be saved using a purely pixel-based file format that supports the color requirements of commercial printing. PSD (Photoshop) and TIFF are the most appropriate formats for commercial printing jobs; before using other formats, consult with your prepress service provider.

If you're using an Open Prepress Interface (OPI) server, verify that it creates for-position-only (FPO) images using TIFF or PSD formats. If the images are TIFF or PSD, it may be possible to use built-in trapping, as long as you don't select any Omit For OPI options at output time. (Omit For OPI options are located in the Advanced section of the Print dialog box when a PostScript printer is targeted.)

Note: The behavior and precision of trapping within an OPI workflow depends on many factors, such as the downsampling method the OPI server uses to generate FPO images. For best results, consult with your OPI vendor for information about integrating Adobe trapping solutions with the vendor's OPI server.

[To the top](#)

Trapping imported vector graphics

Both Adobe In-RIP Trapping and built-in trapping can trap text and graphics created with InDesign tools and placed vector PDF files. However, built-in trapping cannot trap placed vector EPS graphics.

The text, paths, and frames you create in InDesign won't trap correctly if they overlap a frame containing a placed graphic that built-in trapping won't trap, such as vector EPS graphics. (However, those objects will trap correctly with Adobe In-RIP Trapping.) You may be able to use built-in trapping with documents containing vector EPS graphics if you adjust the graphic's frame. If the placed EPS graphic isn't rectangular, try reshaping the frame closer to the graphic itself, and away from other objects. For example, you might choose Object > Clipping Path to fit the graphics frame more tightly around the graphic.

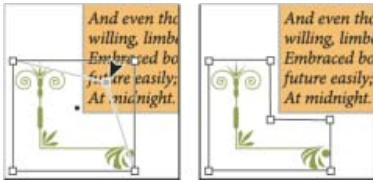

InDesign text and graphics that overlap placed EPS graphics (left) won't trap correctly; to achieve good trapping, reshape the frame so that it doesn't touch other objects (right).

[To the top](#)

Trapping text

Both the Adobe In-RIP and built-in trapping engines can trap text characters to other text and graphics. (Built-in trapping requires that the text and graphics are created with InDesign, and aren't contained in imported graphics.) A text character overlapping different background colors traps accurately to all of the colors.

Adobe In-RIP Trapping can trap all types of fonts. In contrast, built-in trapping works best with Type 1, OpenType, and Multiple Master fonts only; using TrueType fonts may result in inconsistent traps. If your document must use TrueType fonts and you want to use built-in trapping, consider converting all TrueType text to outlines by selecting the text and choosing Type > Create Outlines. The text will become InDesign objects that trap reliably. Text can't be edited after you convert it to outlines.

[To the top](#)

Maximizing trapping performance

Whether you use Adobe In-RIP trapping or built-in trapping, you can save time by not processing pages that don't need trapping, such as pages containing black text only. You can use trap presets to enable trapping only for the page ranges that require it.

The speed with which built-in trapping is accomplished depends on the speed of your computer system. If you're trapping every page of a long document, use the fastest computer system you have. Built-in trapping also makes extensive use of your computer's hard disk, so a fast hard disk and data bus will benefit the built-in trapping engine.

To maximize the time your computers are available for other tasks, consider using Adobe In-RIP Trapping, which processes all traps at the RIP, instead of at your computer.

[To the top](#)

Setting aside disk space for built-in trapping

To trap the edges of every color that requires trapping, the trapping engine creates a large number of paths that are used only by the output device (the paths are not stored in your document). While Adobe In-RIP Trapping processes and stores these additional paths at the RIP, built-in trapping uses your computer's hard disk as a temporary storage area for these trap paths. Before you use built-in trapping, make available as

much hard disk space as possible.

The amount of disk space you'll need depends on a wide range of factors, so it isn't possible to predict exactly what a particular trapping job will require. However, disk space requirements are most likely to increase when one or more of the following characteristics of your document increase:

- Number of pages included in trapping page ranges.
- Number of overlapping color objects.
- Number of images that need to be trapped.
- Amount of text that needs to be trapped.
- Resolution of final output.

If the processing of a job that uses built-in trapping is interrupted or exhausts your disk space, trapping data may be left behind on your hard disk. When necessary, you can exit the application, and then find and delete temporary data in the C:\Temp folder (Windows). In Mac OS, restart your computer.

[To the top](#)

Trap a document or book

Do not change the default trapping settings unless you've consulted with your prepress service provider, and you understand how trapping options work in the context of your specific document and printing conditions.

When trapping multiple documents in a book, make sure that you assign any custom trap presets to page ranges within the individual documents of the book. You cannot assign trapping settings to an entire book at once. However, you can resolve conflicting presets in a document.

1. If necessary, create a trap preset with custom settings for your document and press conditions.
2. Assign the trap preset to a page range.
3. Choose File > Print to open the Print dialog box.
4. Select Output from the list on the left.
5. For Color, choose either Separations or In-RIP Separations, depending on whether you're creating on-host or in-RIP separations.
6. For Trapping, choose one of the following options:
 - Application Built-In, to use the trapping engine included with InDesign.
 - Adobe In-RIP. This option works only when you target an output device that supports Adobe In-RIP Trapping.
7. If your prepress service provider recommends changing ink settings, click Ink Manager. Select an ink, set the options specified by your prepress service provider, and then click OK:
8. Continue specifying other print options, and then click Print to print your document.

Adobe also recommends

 Twitter™ and Facebook posts are not covered under the terms of Creative Commons.

[Legal Notices](#) | [Online Privacy Policy](#)

Printing thumbnails and oversized documents

javax.jcr.AccessDeniedException: /content/help/en/indesign/using/printing-thumbnails-oversized- documents/jcr:content/jcr:title: not allowed to add or modify item

[Print thumbnails](#)
[Printing oversized documents](#)
[Tile a document](#)
[Scale documents](#)

For detailed information and instructions, click the links below.

[To the top](#)

Print thumbnails

To fit multiple pages on a single page, you can create *thumbnails*—small preview versions of your document. Thumbnails are useful for verifying content and organization. Where appropriate, InDesign automatically changes the paper orientation to provide the best fit of the page to the paper; however, you'll need to reset the original orientation if you deselect the Thumbnails option.

Note: *When you print thumbnails, printer's marks and any items in the bleed and/or slug areas are excluded.*

1. In the Setup area of the Print dialog box, select Thumbnails.
2. In the menu, choose the number of thumbnails per page.

[To the top](#)

Printing oversized documents

Although you can create InDesign documents as large as 18-by-18 feet, most desktop printers cannot print such large pages.

To print an oversized document on your desktop printer, you can print each page of your document in pieces, called *tiles*, and then trim and assemble those pieces. If you prefer, you can scale the document to fit the available paper size.

[To the top](#)

Tile a document

A document's dimensions do not necessarily match the paper sizes used by printers. As a result, when you print, InDesign divides the oversized document into one or more rectangles, or tiles, that correspond to the page size available on the printer. You can then assemble the overlapping sections.

You can have InDesign tile a document automatically, or you can specify the tiles yourself. Tiling manually lets you control the origin point for the upper-left corner of the tile, so that you determine where the page falls on the paper.



Oversized pages divided into printable tiles (left) and the overlapping sections in final assembly (right)

Tile a document automatically

1. Choose File > Print.
2. In the Setup area of the Print dialog box, select Tile.
3. Choose one of the following options in the Tile menu:

Auto Automatically calculates the number of tiles required, including the overlap.

Auto Justified Increases the amount of overlap (if necessary) so that the right sides of the rightmost tiles are aligned at the right edge of the document's page, and the bottom sides of the bottommost tiles are aligned at the bottom edge of the document's page.

4. For Overlap, type the minimum amount of duplicated information you want printed on each tile for ease in assembly. The Overlap option uses the unit of measure specified for the document. The value should be greater than the minimum nonprinting margins for the printer. You can specify up to half the size of the shortest side of the document page to overlap. For example, tiles for a page that measures 11-by-17 inches (279.4mm-by-431.8mm) can overlap up to 5.5 inches (139.7mm).

Tile a document manually

While tiling a document automatically prints all the tiles at once, tiling a document manually requires you to print each tile separately.

1. If necessary, choose View > Show Rulers to display the rulers.
2. Drag the intersection of the rulers to reset the zero point to the desired upper-left corner of the tile you want to print. Remember to leave room for overlap and printer's marks.

The size and shape of the area InDesign prints is determined by the current paper size and orientation.

3. Choose File > Print, and then click Setup on the left.
4. In the Setup area, select Tile, and then choose Manual in the Tile menu.

[To the top](#)

Scale documents

To fit an oversized document on a smaller piece of paper, you can scale the document's width and height, either symmetrically or asymmetrically. Asymmetric scaling is useful when, for example, you're printing film for use on a flexographic press: If you know in which direction the plate will be mounted on the press drum, scaling can compensate for the 2% to 3% stretching of the plate that usually occurs. Scaling does not affect the size

of the pages in the document.

Note: *When you print spreads, each spread is scaled separately.*

Scale a document manually

1. Choose File > Print.
2. In the Setup area of the Print dialog box, select Width to activate the Width and Height boxes.
3. To maintain current document width to height proportions, select Constrain Proportions. Otherwise, make sure that this option is unselected.
4. Type percentages from 1 to 1000 in the Width and Height boxes. If you selected Constrain Proportions, you need to enter only one value; the other is updated automatically.

Scale a document automatically

1. In the Setup area of the Print dialog box, make sure that the Tile and Thumbnail options are unselected. (When these options are selected, the Scale To Fit option is unavailable.)
2. Select Scale To Fit. The scaling percentage, which is determined by the imageable area defined by the selected PPD, appears next to the Scale To Fit option.

Adobe also recommends

 Twitter™ and Facebook posts are not covered under the terms of Creative Commons.

[Legal Notices](#) | [Online Privacy Policy](#)

Printing graphics and fonts

- [Options for printing graphics](#)
- [Options for downloading fonts to a printer](#)
- [PostScript printing options](#)
- [Options for omitting graphics](#)

[To the top](#)

Options for printing graphics

Choose from the following options in the Graphics area of the Print dialog box to specify how graphics are handled during output.

Send Data Controls how much image data in placed bitmap images to send to the printer or file.

All Sends full-resolution data, which is appropriate for any high-resolution printing, or for printing grayscale or color images with high contrast, as in black-and-white text with one spot color. This option requires the most disk space.

Optimized Subsampling Sends just enough image data to print the graphic at the best possible resolution for the output device. (A high-resolution printer will use more data than a low-resolution desktop model.) Select this option when you're working with high-resolution images but printing proofs to a desktop printer.

Note: *InDesign does not subsample EPS or PDF graphics, even when Optimized Subsampling is selected.*

Proxy Sends screen-resolution versions (72 dpi) of placed bitmap images, thereby reducing printing time.

None Temporarily removes all graphics when you print and replaces them with graphics frames with crossbars, thereby reducing printing time. The graphics frames are the same dimensions as the imported graphics and clipping paths are maintained, so you can still check sizes and positioning. Suppressing the printing of imported graphics is useful when you want to distribute text proofs to editors or proofreaders. Printing without graphics is also helpful when you're trying to isolate the cause of a printing problem.

[To the top](#)

Options for downloading fonts to a printer

Printer-resident fonts are stored in a printer's memory or on a hard drive connected to the printer. Type 1 and TrueType fonts can be stored either on the printer or on your computer; bitmap fonts are stored only on your computer. InDesign downloads fonts as needed, provided they are installed on your computer's hard disk.

Choose from the following options in the Graphics area of the Print dialog box to control how fonts are downloaded to the printer.

None Includes a reference to the font in the PostScript file, which tells the RIP or a post-processor where the font should be included. This option is appropriate if the fonts reside in the printer. However, to ensure that fonts are interpreted correctly, use one of the other font downloading options, such as Subset or Download PPD Fonts.

Complete Downloads all fonts required for the document at the beginning of the print job. All glyphs and characters in the font are included even if they're not used in the document. InDesign automatically subsets fonts that contain more than the maximum number of glyphs (characters) specified in the Preferences dialog box.

Subset Downloads only the characters (glyphs) used in the document. Glyphs are downloaded once per page. This option typically results in faster and smaller PostScript files when used with single-page documents or short documents without much text.

Download PPD Fonts Downloads all fonts used in the document, even if those fonts reside in the printer. Use this option to ensure that InDesign uses the font outlines on your computer for printing common fonts, such as Helvetica and Times. Using this option can resolve problems with font versions, such as mismatched character sets between your computer and printer or outline variances in trapping. Unless you commonly use extended character sets, you don't need to use this option for desktop draft printing.

[To the top](#)

PostScript printing options

Choose from the following options in the Graphics area of the Print dialog box to specify how PostScript information is sent to the printer.

PostScript Specifies a level of compatibility with the interpreters in PostScript output devices.

Data Format Specifies how InDesign sends the image data from your computer to a printer. ASCII is sent as ASCII text, which is compatible with older networks and parallel printers and is usually the best choice for graphics used on multiple platforms. Binary exports as binary code, which is more compact than ASCII but may not be compatible with all systems.

Note: *InDesign cannot always change the data format used by EPS or DCS graphics files. If you experience problems sending data as Binary, try changing the data format of EPS or DCS graphics in the source application instead.*

[To the top](#)

Options for omitting graphics

The OPI options in the Advanced area let you selectively omit different imported graphics types when sending image data to a printer or file, leaving only the OPI links (comments) for later handling by an OPI server.

OPI Image Replacement Enables InDesign to replace low-resolution EPS proxies of graphics with high-resolution graphics at output time. For OPI image replacement to work, the EPS file must contain OPI comments that link the low-resolution proxy image to the high-resolution image. InDesign must have access to the graphics linked by the OPI comments. If the high-resolution versions are not available, InDesign preserves the OPI links and includes the low-resolution proxy in the export file. Deselect this option to have an OPI server replace OPI-linked graphics later in the workflow.

Omit For OPI Lets you selectively omit different imported graphics types (EPS, PDF, and bitmap images) when sending image data to a printer or file, leaving only the OPI links (comments) for later handling by an OPI server. The comments contain the information needed to locate a high-resolution image on an OPI server. InDesign only includes the comments; the service provider must have access to the original high-resolution image on a server at replacement time. The Omit For OPI option doesn't apply to embedded graphics.

Adobe also recommends

 Twitter™ and Facebook posts are not covered under the terms of Creative Commons.

[Legal Notices](#) | [Online Privacy Policy](#)

Overprinting

About overprinting

Determining when to overprint manually

Overprinting page items

Change the black overprint setting

For detailed information and instructions, click the links below.

[To the top](#)

About overprinting

If you have not changed the transparency of your artwork with the Transparency panel, the fills and strokes in the artwork will appear opaque, because the top color *knocks out*, or cuts out, the area underneath. You can prevent knockout by using the Overprint options in the Attributes panel. After you've set your overprint options, you can preview the overprinting effects on-screen.



Three overlapping circles without overprinting (left) compared to three overlapping circles with overprinting (right)

InDesign also has overprint simulation, which is useful for simulating the effects of overprinting spot and process inks on a composite printing device.

Black ink applied to text or native InDesign objects is overprinted by default to prevent misregistration of small black-type characters positioned over color areas, or of color areas outlined with black lines. You can change black ink settings using Appearance Of Black preferences.

Your design workflow may require a certain color to be set to overprint. For example, you want to print all the text in your publication in a specific color. Consider the following options:

- Create an object style that uses the spot ink as the fill or stroke with a matching overprint fill or stroke.
- Create a separate layer for objects that contain your spot color and assign them to black.
- Create a composite PDF and change overprint settings within the PDF.
- Assign overprint settings in your RIP.
- Apply overprint settings to an image or object and add it to your library, or edit a placed file in its original application.

[To the top](#)

Determining when to overprint manually

Automatic trapping in InDesign—either as built-in trapping or Adobe In-RIP Trapping—nearly eliminates the need for manual overprinting. However, manual overprinting can be an effective solution in the rare cases when you can't use automatic trapping.

Use the following guidelines to determine whether or not to use overprinting:

- Consult with your service provider to see if their output devices support manual overprinting.

- Overprint when the artwork doesn't share common ink colors and you want to create a trap or overlaid ink effects. When overprinting process color mixes or custom colors that don't share common ink colors, the overprint color is added to the background color. For example, if you print a fill of 100% magenta over a fill of 100% cyan, the overlapping fills appear violet, not magenta.
- Don't overprint when using a stroke to trap two process colors. Instead, you specify a CMYK stroke color that uses the higher value from the corresponding inks in each original color.
- Make sure that you and your prepress service provider agree on when and how to overprint manually, because doing so will significantly affect trapping options specified in the Print dialog box. Overprinting is supported by most, but not all, PostScript Level 2 and PostScript 3 devices.

[To the top](#)

Overprinting page items

You can overprint strokes or fills, paragraph rules, and rules above footnotes. You can also simulate overprinting of spot colors.



Overprint a stroke or fill

You can overprint strokes or fills of any selected paths using the Attributes panel. An overprinted stroke or fill doesn't need to be trapped, because overprinting covers any potential gaps between adjacent colors. You can also overprint a stroke to simulate a trap (by overprinting a color you've manually calculated as the proper combination of two adjacent colors).

Keep the following guidelines in mind as you apply manual overprinting:

- If you use the Overprint Fill option on a 100% black stroke or fill, the black ink may not be opaque enough to prevent the underlying ink colors from showing through. To eliminate the show-through problem, use a four-color (rich) black instead of a 100% black. Consult with your service provider about the exact percentages of color to add to the black.
- When using a stroke to trap objects (but not text characters), adjust the stroke alignment so the stroke falls outside the path or object, rather than inside or centered on the path.
- When using a stroke to trap two spot colors or a spot and a process color, you usually apply the lighter color to the stroke, and overprint the stroke.

Use the Separations Preview panel to preview how colors will overprint.

1. Select one or more paths with the Selection tool  or the Direct Selection tool , or select text characters with the Type tool. To overprint the stroke of a path that is pasted inside a frame, you must first select the nested (inner) path using the Direct Selection tool.

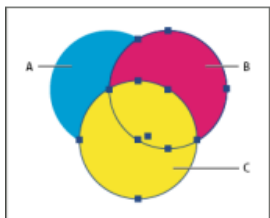

Overprinting fills and strokes

A. Cyan (bottom layer) **B.** Magenta (middle layer) **C.** Yellow (top layer)

2. Choose Window > Output > Attributes.

3. In the Attributes panel, do any of the following:

- To overprint the fill of selected objects, or to overprint unstroked type, select Overprint Fill.
- To overprint the stroke of selected objects, select Overprint Stroke.
- To overprint a color applied to the spaces in a dashed, dotted, or patterned line, select Overprint Gap.

Overprint a paragraph rule

1. Make sure a swatch exists for your overprint color.
2. Using the Type tool, click an insertion point in a paragraph.
3. In the Paragraph panel, choose Paragraph Rules in the Paragraph panel menu.
4. In the pop-up menu at the top of the dialog box, choose the paragraph rule you want to overprint.
5. Select one of the following, then click OK.
 - To overprint the stroke of the rule, select Overprint Stroke.
 - To overprint a color applied to the spaces in a dashed, dotted, or patterned line, select Overprint Gap.

Note: *The Overprint Stroke and Overprint Gap options in the Paragraph Rules dialog box can be saved as part of a paragraph style.*

Overprint rules above footnotes

InDesign can automatically insert a rule to separate footnotes from the body of the document. You can choose to overprint the rule.

1. Make sure a swatch exists for your overprint color.
2. Choose Type > Document Footnote Options.
3. In the Footnote Options dialog box, click the Layout tab.
4. Select Overprint Stroke, and click OK.

Simulate overprinting of spot inks

Overprint simulation is useful for simulating the effects of overprinting spot inks with different neutral density values (for example, red and blue). When you print to a composite output device using overprint simulation, you can see if the resulting color is one that you want to overprint or knock out.

1. In the Output area of the Print dialog box, choose a composite option in the Color menu.

Note: *You cannot simulate overprinting when Composite Leave Unchanged is selected.*

2. Select Simulate Overprint.

[To the top](#)

Change the black overprint setting

To knock out black objects in InDesign, you must prevent the black swatch from overprinting. Unlike most color swatches, which knock out by default, the black swatch overprints by default, including all black strokes, fills, and text characters. The 100% process black appears as [Black] in the Swatches panel. Knock out black objects by either deselecting the overprint default in Preferences or by duplicating the default black swatch

and applying the duplicated swatch to color objects that knock out. If you disable the overprint setting in the Preferences dialog box, all instances of Black knock out (remove underlying inks).

 *It can be cheaper and easier to have the print shop overprint process black on the press.*

1. Choose Edit > Preferences > Appearance Of Black (Windows) or InDesign > Preferences > Appearance Of Black (Mac OS).
2. Select or deselect Overprint [Black] Swatch at 100%.

Note: *Overprint [Black] Swatch at 100% does not affect tints of [Black], unnamed black colors, or objects that appear black because of their transparency settings or styles. It affects only objects or text colored with the [Black] swatch.*

Adobe also recommends

- Change the appearance of CMYK black (Illustrator, InDesign)

 Twitter™ and Facebook posts are not covered under the terms of Creative Commons.

[Legal Notices](#) | [Online Privacy Policy](#)

Managing color

[Use color management when printing](#)

[Color output options for composites](#)

[Print a hard proof](#)

[Improving gradients and color blends in print](#)

[About halftone dots and printer dots](#)

For detailed information and instructions, click the links below.

[To the top](#)

Use color management when printing

When you print a color-managed document, you can specify additional color management options to keep color consistent in the printer output. For example, suppose that your document currently contains a profile tailored for prepress output, but you want to proof the document colors on a desktop printer. In the Print dialog box, you can convert the document's colors to the color space of the desktop printer; the printer profile will be used instead of the current document profile. If you select the Proof color space and target an RGB printer, InDesign converts color data to RGB values using the selected color profiles.

When printing to a PostScript printer, you also have the option of using PostScript color management. In this instance, InDesign sends the document's color data in a calibrated version of its original color space, along with the document profile, directly to the PostScript printer and lets the printer convert the document to the printer color space. The printer's color space is stored at the device as a color rendering dictionary (CRD); this makes device-independent output possible. CRDs are PostScript equivalents of color profiles. The exact results of the color conversion can vary among printers. To use PostScript color management, you must have a printer that uses PostScript Level 2 or higher; it is not necessary to install an ICC profile for the printer on your system.

Note: *While working on a color-managed document, you can use the Preflight panel to make sure that your colors conform to the guidelines you specify.*

1. Make sure that you've installed the correct driver and PPD for your printer.
2. Choose File > Print.
3. If a printer preset has the settings you want, choose it in the Printer Preset menu at the top of the Print dialog box.
4. Adjust settings as desired for this document.
5. Click Color Management on the left side of the Print dialog box.
6. Under Print, select Document.
7. For Color Handling, choose Let InDesign Determine Colors.
8. For Printer Profile, select the profile for your output device.

The more accurately the profile describes the behavior of an output device and printing conditions (such as paper type), the more accurately the color management system can translate the numeric values of the actual colors in a document.

9. Select Preserve RGB Numbers or Preserve CMYK Numbers.

This option determines how InDesign handles colors that do not have a color profile associated with them (for example, imported images without embedded profiles). When this option is selected, InDesign sends the color numbers directly to the output device. When this option is deselected, InDesign first converts the color numbers to the color space of the output device.

Preserving numbers is recommended when you are following a safe CMYK workflow. Preserving numbers is not recommended for printing RGB documents.

10. Press either Setup (Windows) or Printer (Mac OS) to access the printer driver dialog box.

11. Turn off color management for the printer, and click Print to return to the InDesign Print dialog box.

Every printer driver has different color management options. If it's not clear how to turn off color management, consult your printer documentation.

12. Click Print.

[To the top](#)

Color output options for composites

In the Output area of the Print dialog box, you can determine how composite color in the document is sent to the printer. When color management is enabled (the default), the Color setting defaults result in calibrated color output. Spot color information is preserved during color conversion; only the process color equivalents convert to the designated color space. If you're not sure which color choice to use, consult your prepress service provider.

Composite modes only affect rasterized images and objects created using InDesign; placed graphics (such as EPS and Adobe PDF files) are not affected unless they overlap transparent objects.

For more information on composite printing, see the Adobe Print Resource Center at www.adobe.com/go/print_resource.

Note: *The options available for non-PostScript printing depend on the color model the printer uses, which is usually RGB.*

When you print as composite, automatic trapping is disabled; however, you can select the Simulate Overprint option to proof overprinting for text, strokes, or fills.

The Output area in the Print dialog box includes the following Color options. Additional options may also be available, depending on your printer.

Composite Leave Unchanged Sends a full-color version of specified pages to the printer, preserving all color values in the original document. When this option is selected, Simulate Overprint is disabled.

Composite Gray Sends grayscale versions of specified pages to the printer when, for example, you are printing to a monochrome printer without making separations.

Composite RGB Sends a full-color version of specified pages to the printer when, for example, you are printing to an RGB color printer without making separations.

Composite CMYK Sends a full-color version of specified pages to the printer when, for example, you are printing to a CMYK color printer without making separations. (This option is available only for PostScript printers.)

Separations Creates PostScript information for each of the separations required for the document, and sends that information to the output device. (This option is available only for PostScript printers.)

In-RIP Separations Sends separation information to the output device's RIP. (This option is available only for PostScript printers.)

Text As Black Select this option to print all text created in InDesign in black, unless it has the color None or Paper or a color value that equals white. This option is useful when you're creating content for both print and PDF distribution. For example, if hyperlinks were blue in the PDF

version, they would print black on a grayscale printer, rather than in halftone patterns that would be difficult to read.

[To the top](#)

Print a hard proof

A hard proof (sometimes called a *proof print* or *match print*) is a printed simulation of what your final output on a printing press will look like. A hard proof is produced on an output device that's less expensive than a printing press. In recent years some inkjet printers have the resolution necessary to produce inexpensive prints that can be used as hard proofs.

1. Choose View > Proof Setup > Custom.
2. In the Customize Proof Condition dialog box, select the device you want to simulate, and click OK.
3. Select Preserve RGB Numbers or Preserve CMYK numbers, and click OK.

This option determines how InDesign handles colors that do not have a color profile associated with them (for example, imported images without embedded profiles). When this option is selected, InDesign sends the color numbers directly to the output device. When this option is deselected, InDesign first converts the color numbers to the color space of the output device.

Preserving numbers is recommended when you are following a safe CMYK workflow. Preserving numbers is not recommended for printing RGB documents.

4. Choose File > Print.
5. If a printer preset has the settings you want, choose it in the Printer Preset menu at the top of the Print dialog box.
6. Adjust settings as desired for this document.
7. Click Color Management on the left side of the Print dialog box.
8. Under Print, select Proof. The profile should match the proof setup you specified.
9. For Color Handling, choose Let InDesign Determine Colors.
10. Select Simulate Paper Color to simulate the specific shade of white exhibited by the print medium as defined by a document's profile (absolute colorimetric rendering intent). This option is not available for all profiles.
11. Press either Setup (Windows) or Printer (Mac OS) to access the printer driver dialog box.
12. Turn off color management for the printer, and click Print to return to the InDesign Print dialog box.

Every printer driver has different color management options. If it's not clear how to turn off color management, consult your printer documentation.

13. Click Print.

[To the top](#)

Improving gradients and color blends in print

PostScript Level 2 and PostScript 3 output devices can print up to 256 shades of gray, and most PostScript desktop laser printers are capable of printing approximately 32 to 64 shades, depending on the device resolution, specified screen frequency, and halftoning method. Banding occurs

when each available shade covers an area large enough for you to see individual shades. Also, if you specify a gradient using two percentage values that differ by less than 50%, you're specifying a narrow range of shades that's more likely to result in banding. If you have difficulty printing smooth gradients without banding, try these techniques:

- Use a gradient that changes at least 50% between two or more process color components.
- Specify lighter colors, or shorten the length of dark gradients. Banding is most likely to occur between very dark colors and white.
- Increase the percentage of change in the gradient.
- Decrease the screen frequency for the document (PostScript output devices only).
- If banding occurs in an imported graphic, such as an Adobe Illustrator® file, you might need to adjust the original graphic.
- Print to a PostScript® 3 output device, which is capable of producing smoother gradients.
- Use shorter gradients. The optimum length depends on the colors in the gradient, but try to keep gradients shorter than 7.5 inches.

[To the top](#)

About halftone dots and printer dots

Most printers simulate gray by using halftone dots printed on a grid; the grid cells are called *halftone cells*, and the grid rows are called *lines* or *line screens*. Each halftone dot is made up of printer dots. As the halftone cell fills up with printer dots, the halftone dot gets larger, resulting in a darker shade of gray.

Printer resolution determines the number of dots available to create the halftone dot. A printer with smaller dots can produce a wider variety of halftone dot sizes, allowing more shades of gray. Screen frequency also plays a role: As screen frequency increases, the halftone cell gets smaller, and so can hold fewer printer dots, resulting in fewer possible shades of gray. As a result, there is a trade-off between the number of possible gray levels and image coarseness.

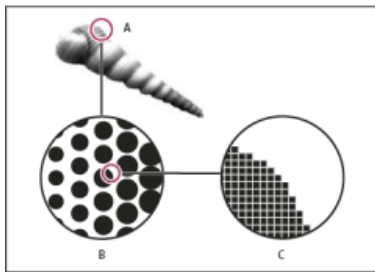

Simulating continuous tone with printer dots

A. Continuous tone simulated by line screen **B.** Line screen consisting of halftone dots in rows **C.** Halftone dots consisting of printer dots

Adobe also recommends

- [Color management](#)
- [Working with color profiles](#)
- [Adobe Print Resource Center](#)
- [Color-managing imported images](#)

Twitter™ and Facebook posts are not covered under the terms of Creative Commons.

[Legal Notices](#) | [Online Privacy Policy](#)

Inks, separations, and screen frequency

[Ink Manager overview](#)

[Specify which colors to separate](#)

[Separate spot colors as process](#)

[Create an ink alias for a spot color](#)

[Display or output spot colors using Lab values](#)

[About halftone screen frequency](#)

[Specify a halftone screen frequency and resolution](#)

[About emulsion and image exposure](#)

[Specify emulsion](#)

[Specify the image exposure](#)

[Checking separation and document settings](#)

[Proofing color separations](#)

[Producing in-RIP separations](#)

[Print or save separations](#)

For detailed information and instructions, click the links below.

[To the top](#)

Ink Manager overview

The Ink Manager provides control over inks at output time. Changes you make using the Ink Manager affect the output, not how the colors are defined in the document.

Ink Manager options are especially useful for print service providers. For example, if a process job includes a spot color, a service provider can open the document and change the spot color to the equivalent CMYK process color. If a document contains two similar spot colors when only one is required, or if the same spot color has two different names, a service provider can map the two to a single alias.

In a trapping workflow, the Ink Manager lets you set the ink density for controlling when trapping takes place, and it lets you set the correct number and sequence of inks.

Note: *InDesign and Acrobat share the same Ink Manager technology. However, only InDesign has the Use Standard Lab Values For Spots option.*

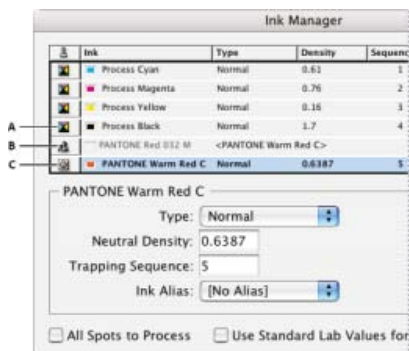

Ink Manager

A. Process ink **B.** Aliased Spot ink **C.** Spot ink

Open the Ink Manager

Do one of the following:

- From the Separations Preview panel menu (Window > Output > Separations Preview), choose Ink Manager.
- Choose File > Print, and click Output. In the Output section, click Ink Manager.

[To the top](#)

Specify which colors to separate

Each separation is labeled with the color name that InDesign assigned it. If an icon of a printer appears next to the color name, InDesign creates a separation for the color. Any spot inks—including those defined and used in imported PDF files or EPS graphics—also appear in the ink list.

1. In the Output area of the Print dialog box, select Separations or, if you use a PPD file that supports in-RIP separations, select In-RIP Separations.
2. Do one of the following:
 - To create a separation, make sure that the printer icon is displayed next to the color name in the ink list.
 - To choose not to create a separation, click the printer icon next to the color's name. The printer icon disappears.

[To the top](#)

Separate spot colors as process

Using the Ink Manager, you can convert spot colors to process colors. When spot colors are converted to process color equivalents, they are printed as separations rather than on a single plate. Converting a spot color is useful if you've accidentally added a spot color to a process color document, or if the document contains more spot colors than are practical to print.

1. In the Ink Manager, do one of the following:
 - To separate individual spot colors, click the ink-type icon to the left of the spot color or aliased spot color. A process color icon appears. To change the color back to spot, click the icon again.
 - To separate all spot colors, select All Spots To Process. The icons to the left of the spot colors change to process color icons. To restore the spot colors, deselect All Spots To Process.

Note: *Selecting All Spots To Process removes any ink aliases you've set up in the Ink Manager and can also affect overprinting and trapping settings in the document.*

2. (InDesign only) To use the Lab values of a spot color rather than CMYK definitions, choose Use Standard Lab Values For Spots.

[To the top](#)

Create an ink alias for a spot color

You can map a spot color to a different spot or process color by creating an alias. An alias is useful if a document contains two similar spot colors when only one is required, or if it contains too many spot colors. You can see the effects of ink aliasing in the printed output, and you see the effects on-screen if Overprint Preview mode is on.

1. In the Ink Manager, select the spot color ink you want to create an alias for.
2. Choose an option in the Ink Alias menu. The ink type icon and ink description change accordingly.

[To the top](#)

Display or output spot colors using Lab values

Some predefined spot colors, such as colors from the TOYO, PANTONE, DIC, and HKS libraries, are defined using Lab values. For backward compatibility with previous versions of InDesign, colors from these libraries also include CMYK definitions. Lab values, when used in conjunction with the correct device profiles, give you the most accurate output across all devices. If color management is critical to your project, you might prefer to display, export, and print spot colors using their Lab values. The Ink Manager option Use Standard Lab Values For Spots lets you control which color mode InDesign uses for these predefined spot colors: Lab or CMYK. If you need the output to match earlier versions of InDesign, you should use the CMYK equivalent values.

Note: To improve on-screen accuracy, InDesign uses the Lab values automatically if Overprint Preview is on. It also uses Lab values when printing or exporting if you've selected Simulate Overprint in the Output area of either the Print or Export Adobe PDF dialog box.

1. Choose Ink Manager in the Separations Preview panel menu.
2. Do one of the following:
 - For Lab values, select Use Standard Lab Values For Spots.
 - For CMYK values, deselect Use Standard Lab Values For Spots.

[To the top](#)

About halftone screen frequency

In commercial printing, continuous tone is simulated by dots (called *halftone dots*) printed in rows (called *lines* or *line screens*). Lines are printed at different angles to make the rows less noticeable. The Screening menu in the Output section of the Print dialog box displays the recommended sets of line screens in lines per inch (lpi), and resolution in dots per inch (dpi), based on the currently selected PPD. As you select inks in the ink list, the values in the Frequency and Angle boxes change, showing you the halftone screen frequency and angle for that ink.

A high line-screen ruling (for example, 150 lpi) spaces the dots closely together to create a finely rendered image on the press; a low line-screen ruling (60 lpi to 85 lpi) spaces the dots farther apart to create a coarser image. The size of the dots is also determined by the line screen. A high line-screen ruling uses small dots; a low line-screen ruling uses large dots. The most important factor in choosing a line-screen ruling is the type of printing press your job will use. Ask your service provider how fine a line screen its press can hold, and make your choices accordingly.

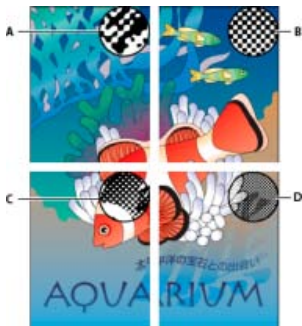

Line screens

A. 65 lpi: Coarse screen for printing newsletters and grocery coupons **B.** 85 lpi: Average screen for printing newspapers **C.** 133 lpi: High-quality screen for printing four-color magazines **D.** 177 lpi: Very fine screen for printing annual reports and images in art books

The PPD files for high-resolution imagesetters offer a wide range of possible screen frequencies, paired with various imagesetter resolutions. The PPD files for low-resolution printers typically have only a few choices for line screens, usually coarser screens of between 53 lpi and 85 lpi. The coarser screens, however, give optimum results on low-resolution printers. Using a finer screen of 100 lpi, for example, actually decreases the quality of your image when you use a low-resolution printer for final output.

[To the top](#)

Specify a halftone screen frequency and resolution

- In the Output section of the Print dialog box, choose one of the following options:

- To select one of the preset screen frequencies and printer resolution combinations, choose an option in the Screening menu.
- To specify a custom halftone screen frequency, select the plate to be customized, and then enter the lpi value in the Frequency text box and a screen angle value in the Angle text box.

Note: Before creating your own halftone screens, check with your service provider for the preferred frequencies and angles. Also, be aware that some output devices override the default frequencies and angles.

[To the top](#)

About emulsion and image exposure

Depending on the type of printing press used and how information is transferred from the film to the printing plates, you may need to give your service provider film negatives or positives, with emulsion side up or down. *Emulsion* refers to the photosensitive layer on a piece of film or paper. Typically, print service providers require negative film in the United States and positive film in Europe and Japan. Check with your service provider to determine which emulsion direction they prefer.

To tell whether you are looking at the emulsion side or the nonemulsion side (also referred to as the *base*), examine the final film under a good light. One side appears shinier than the other. The dull side is the emulsion side; the shiny side is the base.

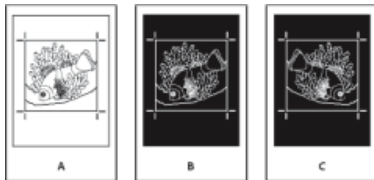

Emulsion options

A. Positive image **B.** Negative **C.** Negative with emulsion side down

Note: The emulsion and image exposure settings in the Print dialog box override any conflicting settings in the printer driver. Always specify print settings using the Print dialog box.

[To the top](#)

Specify emulsion

1. In the Output section of the Print dialog box, for Color, choose Composite Gray or a separation option.
2. For Flip, select one of the following options:

None (the default) Makes no changes to the orientation of the imageable area. Type in the image is readable (that is, *right reading*) when the photosensitive layer is facing you.

Horizontal Mirrors the imageable area across a vertical axis so that it is *wrong reading*.

Vertical Mirrors the imageable area across a horizontal axis so that it is upside down.

Horizontal & Vertical Mirrors the imageable area across the horizontal and vertical axes so that it is wrong reading. Type is readable when the photosensitive layer is facing away from you. Images printed on film are often printed Horizontal & Vertical.

[To the top](#)

Specify the image exposure

1. In the Output section of the Print dialog box, for Color, choose Composite Gray or a separation option.

2. Select or deselect the Negative option.

[To the top](#)

Checking separation and document settings

The Summary area of the Print dialog box displays a summary of color management information, printer's marks dimensions, and bleeds for the document. The section also indicates whether trapping has been enabled.

You can also perform a quality check before printing or handing off the document to a service provider.

[To the top](#)

Proofing color separations

Create a hard proof to verify that colors will print on the correct separations, or a soft proof to preview how your document's colors will look when reproduced on a particular output device.

Note: *While no proof will give you an exact representation of your final output, you can greatly improve its accuracy by calibrating all the devices you use to create a document (such as scanners, monitors, and printers). If the devices are calibrated, the color management system can help you get predictable and consistent color.*

The hard proof represents your expectation of the way the final separations will appear, and helps the service provider to verify that the output is correct. Be sure to print proofs on a PostScript printer; you cannot reliably proof color separations printed from a non-PostScript printer.

 *For assurance that the file will print correctly, consider saving the separations as a PostScript file, converting the PostScript file to Acrobat 8 PDF using Acrobat Distiller, and then viewing the PDF document in Acrobat. By viewing the PDF document in Acrobat, you can inspect high-quality PostScript output on-screen at a high level of detail.*

[To the top](#)

Producing in-RIP separations

To produce in-RIP separations, you need the following software and hardware:

- A PPD file that supports in-RIP separations.
- Any PostScript 3 output device, or a PostScript Level 2 device whose RIP supports in-RIP separations. If the document contains duotones from Photoshop 5.0 or later, a PostScript 3 device is required to generate in-RIP separations.

Note: *Depending on the prepress software available, a service provider may be able to perform such prepress activities as trapping, imposition, separating, and OPI replacement at the output device's RIP. Therefore, your service provider may prefer to receive a composite PostScript file of the document optimized for in-RIP separations, rather than a pre-separated PostScript file.*

[To the top](#)

Print or save separations

1. At the top of the Print dialog box, choose a preset in the Print Preset menu, if one with the appropriate separation settings exists.
2. Do one of the following:
 - To print to an output device, choose the device in the Printer menu.
 - To print to a file, choose PostScript® File in the Printer menu. Then choose a PPD that supports the output device.
3. Click General, and specify the pages to separate.

4. Click Output, and do one of the following:

- To print to an output device, choose Separations to create the separations in InDesign.
- To print to a file, choose either Separations, or In-RIP Separations to save separation settings in a composite PostScript file for processing in the RIP.

Note: To use Adobe In-RIP Trapping, you must be working with in-RIP rather than host-based separations. Otherwise, the trapping feature won't have access to all of the colors at once, and trapping won't occur.

5. Click Graphics, and do the following:

- For Send Data, choose All.
- For Download, choose Complete or Subset, unless fonts will be inserted later (for example, at the RIP or by a post-processing application).
- For PostScript®, select the PostScript level of the output device: Level 2 or Level 3.

6. Click Advanced, and do any of the following:

- To replace low-resolution graphics embedded in placed EPS files with their high-resolution versions at output time, make sure that Read Embedded OPI Image Links was selected when the EPS file was placed in the InDesign document, and then select OPI Image Replacement in the Advanced area of the Print dialog box.
- To omit different imported graphics types for later replacement by an OPI server, select from the Omit For OPI options.
- For Transparency Flattener Preset, choose [High Resolution] or an available custom style with high-resolution settings.

7. Choose any other print options.

8. Do one of the following:

- To print to an output device, click Print.
- To print to a file, click Save and accept the default filename, or type another name for the file. Then click Save again.

Note: Once you've created separations of the InDesign document, the settings you've chosen in the Print dialog box are saved with the separated file. The file saves the separation settings, the PPD information, and any color conversions you have specified in the Print dialog box.

Adobe also recommends

- Proofing colors

 Twitter™ and Facebook posts are not covered under the terms of Creative Commons.

[Legal Notices](#) | [Online Privacy Policy](#)

Creating PostScript and EPS files

Creating PostScript or EPS files

[Choosing the right method for creating a PostScript file](#)

[About device- and driver-dependent PostScript files](#)

[Create a device-independent PostScript file](#)

[Create a device-dependent PostScript file using InDesign](#)

[Create a PostScript file using a PostScript printer driver \(Windows\)](#)

[Create a PostScript file using a PostScript printer driver \(Mac OS\)](#)

[Export pages in EPS format](#)

For detailed information and instructions, click the links below.

[To the top](#)

Creating PostScript or EPS files

As an alternative to printing a document to a printer, you can save a PostScript-language description of the document as a .PS file for printing on remote printers—for example, by a prepress service provider. A service provider can send a .PS file directly to the imagesetter. The size of a PostScript file is usually larger than the original InDesign document, because the graphics and fonts are embedded.

You can also export a document page or spread to an EPS (Encapsulated PostScript) file and place it in other applications.

[To the top](#)

Choosing the right method for creating a PostScript file

You can save your InDesign document or book in any of three types of PostScript files: device-independent, device-dependent, or device- and driver-dependent.

The following tables list recommended printer drivers and output methods for achieving the best results with post-processing applications and InDesign. If your document will be processed by an OPI server, or by an imposition, trapping, or other prepress application before it is printed by a RIP, choose PostScript® File in the Printer menu in the InDesign Print dialog box. That way, InDesign has complete control over the DSC output. For desktop printing, use any supported PostScript printer driver.

The tables use asterisks to indicate the relative suitability of each method for prepress work:

*** The PostScript file is fully DSC-compliant, and very suitable for use with a wide variety of post-processing applications, RIPs, and workflows. This method is the best all-round choice for applications that rely on DSC.

** The PostScript file is largely DSC-compliant, and generally suitable for use with a wide variety of post-processing applications, RIPs, and workflows. Some compatibility issues may exist for certain types of applications that rely heavily on DSC.

Printer selection: PostScript® File		
Operating system	PPD	Prepress suitability
All platforms	Device-independent	***
	Device-dependent	***

A printer driver isn't used when the printer selection is "PostScript® File."

Printer selection: <installed printer>		
Operating system	Printer driver	Prepress suitability
Mac OS 10.2	Built-in PS Driver for Mac OS X	**
Windows 2000/XP	Pscript 5	**

The PPD used by the selected printer appears in the PPD text box at the top of the Print dialog box.

[To the top](#)

About device- and driver-dependent PostScript files

Select a printer and a supported driver in the Printer menu. A device- and driver-dependent PostScript file has the following characteristics:

- It is driver-dependent. The PostScript file will contain code generated by InDesign and by the driver. The InDesign code is primarily responsible for the page content, including font downloading, and for setting basic device information, such as media size, resolution, and screening. The driver is primarily responsible for setting special driver features, such as watermarks, and for enabling or controlling special device features. Since InDesign doesn't have complete control over creating the PostScript file, the level of DSC compliance isn't quite as high as it is with driver-independent PostScript files. The level of DSC compliance, and therefore the PostScript file's suitability for prepress tasks, depends on the printer driver used.
- It is device-dependent. It contains code for enabling and controlling specific device features, making it less compatible with devices other than the target device.
- It can be composite or separated (all of the color output methods that InDesign supports are available).
- It can be trapped by InDesign (either by using Application Built-In or Adobe In-RIP Trapping).
- It can be printed directly to the device, or to file.

A device- and driver-dependent PostScript file is ideally suited for proofing (by the designer) to desktop PostScript printers. It can also be used by service providers who don't plan to do any prepress tasks to the job outside of InDesign or the RIP system. In other words, if trapping is done, it happens in InDesign or at the RIP.

[To the top](#)

Create a device-independent PostScript file

Select PostScript File in the Printer menu, and select Device Independent in the PPD menu. A device-independent PostScript file has the following characteristics:

- It is 100% DSC-compliant, making it ideal for such post-processing tasks as trapping and imposition.
- All device and driver dependencies are removed, so that the file will print to almost any output device. However, special printer features found in PPD files, such as image exposure, available media sizes, and optimized screen frequencies, aren't available in device-independent output.
- The color output is always composite CMYK, but it also includes spot colors. As a result, it has to be separated in post-processing software, or at the RIP using in-RIP separations.
- It cannot be trapped by InDesign; trapping must occur at the RIP, or in post-processing software.
- It can only be printed to file (not directly to a device or application) from InDesign.

A device-independent PostScript file is ideal for composite prepress workflows, where the file will be trapped and separated later in the production process, such as during imposition, trapping, or at the RIP (if the output device supports in-RIP separations).

1. Choose File > Print.
2. In the Print dialog box, for Printer, choose PostScript File.
3. For PPD, choose Device Independent.
4. View or change existing print settings. InDesign uses the current page range when creating the PostScript file.
5. Click Save.
6. Specify a name and location, and click Save.

[To the top](#)

Create a device-dependent PostScript file using InDesign

Select PostScript File in the Printer menu, and select a PPD. A device-dependent PostScript file has the following characteristics:

- It is 100% DSC-compliant, making it ideal for such post-processing tasks as trapping and imposition.
- It contains a description of everything in your document, including information about linked files, optimized screen frequencies, resolution, and available media sizes tailored to the currently selected output device.
- All driver dependencies are removed.
- It can be composite or separated. All of the color output methods that InDesign supports are available. (In-RIP separations are available if the PPD and output device support them.)
- It can be trapped by InDesign (either by using Application Built-In or Adobe In-RIP Trapping).
- It can only be printed to file (not directly to a device or application) from InDesign.

A device-dependent PostScript file is ideally suited to pre-separation or trapping workflows, where the file will be trapped using automatic or Adobe In-RIP Trapping features within InDesign.

1. Choose File > Print.
2. In the Print dialog box, for Printer, choose PostScript File.
3. Choose the PPD for the final output device.
4. View or change existing print settings. InDesign uses the current page range when creating the PostScript file.
5. Click Save.
6. Specify a name and location, and click Save.

[To the top](#)

Create a PostScript file using a PostScript printer driver (Windows)

1. Choose File > Print.
2. In the InDesign Print dialog box, click the Setup button at the bottom of the dialog box.

3. In the printer driver's dialog box, select Print to File.
4. Click the Layout tab, and then click the Advanced button.
5. Click Document Options, click PostScript Options, and then choose Optimize For Portability in the PostScript Output Option menu. Click OK.
6. Click OK or Print to return to the InDesign Print dialog box.
7. In the InDesign Print dialog box, click Print.
8. Specify a name and location, and click Save.

[To the top](#)

Create a PostScript file using a PostScript printer driver (Mac OS)

1. Choose File > Print.
2. In the Print dialog box, choose PostScript File in the Printer menu, and click Save.
3. In the Save PostScript File dialog box, specify a name and location for the PostScript file (.ps), and then click Save.

[To the top](#)

Export pages in EPS format

Use the Export command to export InDesign pages in EPS format, which you can import into another program. If you export multiple pages, each page is exported as a separate file with a number appended to the end of the filename. For example, if you export pages 3, 6, and 12, and specify the filename News.eps, InDesign will create three files named News_3.eps, News_6.eps, and News_12.eps.

 *If you want to open InDesign pages in Illustrator or Adobe Photoshop, export pages as PDF or EPS files.*

1. Choose File > Export.
2. Specify a location and a filename. Be sure to include the EPS extension.
3. For Save As Type (Windows) or Format (Mac OS), choose EPS, and click Save.
4. Under Pages in the Export EPS dialog box, do one of the following:
 - Select All Pages to export all pages in the document.
 - Select Ranges and type a page range. You can type a range using a hyphen, and separate pages or ranges using commas.
 - Select Spreads to export facing pages as a single EPS file (one spread per EPS).
5. Set additional options.
6. Under Bleed, type a value between 0p0 and 36p0 to specify extra space for graphics that are positioned beyond the edge of the page or trim area.
7. Click Export.

EPS export options

When you export to EPS, you can specify the following options:

PostScript® Specifies a level of compatibility with the interpreters in PostScript output devices. Level 2 will often improve the printing speed and output quality of graphics printed only on a PostScript Level 2 or greater output device. Level 3 provides the best speed and output quality, but requires a PostScript 3 device.

Color Specifies how color is represented in the exported file. The options below are similar to the Color settings in the Print dialog box.

Leave Unchanged Leaves each image in its original color space. For example, if the document contains three RGB images and four CMYK images, the resulting EPS file will contain the same RGB and CMYK images.

CMYK Creates a separable file by representing all color values using the gamut of cyan, magenta, yellow, and black process color inks.

Gray Converts all color values to high-quality black-and-white images. The gray levels (shades) of the converted objects represent the luminosity of the original objects.

RGB Represents all color values using the red, green, and blue color space. An EPS file with RGB color definitions is better suited for on-screen viewing.

PostScript®Color Management Uses the document's color data in a calibrated version of its original color space.

Preview Determines the characteristics of the preview image that is saved in the file. The preview image is displayed in applications that cannot display EPS artwork directly. If you don't want to create a preview image, choose None in the format menu.

Embed Fonts Specifies how to include fonts used in the pages you export.

None Includes a reference to the font in the PostScript file that tells the RIP or a post-processor where the font should be included.

Complete Downloads all fonts required for the document at the beginning of the print job. All glyphs and characters in a font are downloaded even if they don't appear in the document. InDesign automatically subsets fonts that contain more than the maximum number of glyphs (characters) specified in the Preferences dialog box.

Subset Downloads only the characters (glyphs) used in the document.

Data Format Specifies how InDesign sends the image data from your computer to a printer: as ASCII or Binary data.

Images Specifies how much image data in placed bitmap images to include in the exported file.

All Includes all available high-resolution image data in the exported file and requires the most disk space. Choose this option if the file will be printed on a high-resolution output device.

Proxy Includes only screen-resolution versions (72 dpi) of placed bitmap images in the exported file. Choose this option in conjunction with the OPI Image Replacement option, or if the resulting PDF file will be viewed on-screen.

OPI Image Replacement Enables InDesign to replace low-resolution EPS proxies of graphics with high-resolution graphics at output time.

Omit For OPI Selectively omits imported graphics when sending image data to a printer or file, leaving only the OPI links (comments) for later handling by an OPI server.

Transparency Flattener Select a flattener preset in the Preset menu to specify how transparent objects appear in the exported file. This option is

the same as the Transparency Flattener option that appears in the Advanced area of the Print dialog box.

Ink Manager Corrects any ink options without changing the design of the document.

Adobe also recommends

 Twitter™ and Facebook posts are not covered under the terms of Creative Commons.

[Legal Notices](#) | [Online Privacy Policy](#)

Adjusting ink options for trapping

[Adjusting ink neutral density values](#)
[Customize trapping for specialty inks](#)
[Adjust the trapping sequence](#)

[To the top](#)

Adjusting ink neutral density values

By adjusting the ink neutral density (ND) values that the selected trapping engine uses, you can determine the precise placement of traps. The default ND values for process inks are based on the neutral density readings of process ink swatches that conform to industry standards in different parts of the world. The language version determines which standard it conforms to. For example, the ND values for the U.S. English and Canadian versions conform to the Specifications for Web Offset Publications (SWOP) solid ink density values published by the Graphic Arts Technical Foundation of North America. You can adjust process ink neutral densities to match printing industry standards in other parts of the world.

The trapping engine derives the ND values for a spot color from its CMYK equivalent. For most spot colors, the ND values of their CMYK equivalents are accurate enough for proper trap creation. Spot inks that aren't easily simulated using process inks, such as metallic inks and varnishes, may need their ND values adjusted so that the trapping engine can trap them correctly. By typing new values, you can ensure that an ink that is observably darker or lighter is recognized that way by the trapping engine; the appropriate trap placement is then applied automatically.

You can get the appropriate neutral density value for a given ink by asking your commercial printer. The most accurate method of determining an ink's ND value is by measuring a swatch of the ink with a commercial densitometer. Read the "V" or visual density of the ink (don't use process filters). If the value differs from the default setting, type the new value in the ND text box.

Note: *Changing the neutral density for a spot color affects only how that color will trap. It doesn't change the appearance of that color in your document.*

Follow these guidelines when adjusting ND values:

Metallic and opaque inks Metallic inks are usually darker than their CMYK equivalents, while opaque inks obscure any ink beneath them. In general, you should set the ND values for both metallic and opaque spot colors much higher than their default values to ensure that these spot colors won't spread.

Note: *Setting an ink to Opaque or Opaque Ignore in the Type menu of the Ink Manager prevents an opaque ink from spreading into other colors, unless another opaque ink has a higher ND value.*

Pastel inks These inks are normally lighter than their process equivalents. You may want to set the ND value for these inks lower than their default values to ensure that they spread into adjacent darker colors.

Other spot inks Some spot colors, such as turquoise or neon orange, are significantly darker or lighter than their CMYK equivalents. You can determine whether this is the case by comparing printed swatches of the actual spot inks to printed swatches of their CMYK equivalents. You can adjust the spot ink's ND value higher or lower as necessary.

[To the top](#)

Customize trapping for specialty inks

Using certain inks involves special trapping considerations. For example, if you are using a varnish on your document, you don't want the varnish to affect trapping. However, if you're overprinting certain areas with a completely opaque ink, you don't need to create traps for items underneath. Ink options are available for these situations. It's usually best not to change the default settings, unless your prepress service provider recommends changing them.

Note: *The specialty inks and varnishes used in the document may have been created by mixing two spot inks or by mixing a spot ink with one or more process inks.*

1. Open the Ink Manager and select an ink that requires special treatment.

2. For Type, choose one of the following options, and then click OK:

Normal Use for traditional process inks and most spot inks.

Transparent Use for clear inks to ensure that underlying items trap. Use this option for varnishes and dieline inks.

Opaque Use for heavy, nontransparent inks to prevent trapping of underlying colors but allow for trapping along the ink's edges. Use this option for metallic inks.

Opaque Ignore Use for heavy, nontransparent inks to prevent trapping of underlying colors and to prevent trapping along the ink's edges. Use this option for those inks, such as metallics and varnishes, that have undesirable interactions with other inks.

[To the top](#)

Adjust the trapping sequence

The trapping sequence (also called the *trapping order*) matches the order in which inks are printed at the press, but it doesn't match the order in which separations are produced at the output device.

The trapping sequence is particularly important when you're printing with multiple opaque colors, such as metallic inks. Opaque inks with lower sequence numbers are spread under opaque inks with higher sequence numbers. This process prevents the last applied ink from being spread, and it still creates good traps.

Note: *Don't alter the default trapping sequence without first consulting with your prepress service provider.*

1. Open the Ink Manager. The current trapping sequence is displayed in the Sequence column of the inks list.
2. Select an ink, type a new value for Trapping Sequence, and then press Tab. The sequence number of the selected ink changes, and the other sequence numbers change accordingly.
3. Repeat the previous step for as many inks as necessary, and then click OK.

Adobe also recommends

 Twitter™ and Facebook posts are not covered under the terms of Creative Commons.

[Legal Notices](#) | [Online Privacy Policy](#)

Digital publications

[Applying guide-based Liquid Layout rules](#)

Anne-Marie Concepcion (May. 15, 2012)

video-tutorial

Learn how guide-based Liquid Layout rules work, and how to create liquid guides and ruler guides.

[Applying object-based Liquid Layout rules](#)

Anne-Marie Concepcion (May. 15, 2012)

video-tutorial

Discover how the object-based Liquid Layout rules work, both on-object and via the Liquid Layout panel.

[Understanding Liquid Layout rules](#)

Anne-Marie Concepcion (May. 15, 2012)

video-tutorial

This tutorial defines and demonstrates Liquid Layout, and tours the location of Liquid Layout-related commands and dialog boxes.

[Using basic Liquid Layout rules: Scale, Recenter, and Based on Master](#)

Anne-Marie Concepcion (May. 15, 2012)

video-tutorial

Discover how to apply None, Scale, and Recenter rules when resizing a layout. Also learn the meaning behind "Based on Master."

[Working with Alternate Layouts](#)

Anne-Marie Concepcion (May. 15, 2012)

video-tutorial

Learn how to use Alternate Layouts for both print and digital publishing.

[Changing the email associated with Adobe ID](#)

WHB III (Apr. 24, 2012)

troubleshooting

Change Adobe ID email: DPS

[Controlling order of content export from InDesign to EPUB without changing your layout \(video 04:54\)](#)

Colin Fleming (Jan. 1, 2011)

video-tutorial

Learn how to create and organize articles in the Articles panel for export to EPUB, without changing layout or writing code.

[Creating covers and title pages for EPUB \(video 05:50\)](#)

Colin Fleming (Jan. 1, 2011)

video-tutorial

Learn how to create covers and title pages for your EPUB titles.

[Exporting documents to EPUB \(PDF, 265 KB\)](#)

article (Jan. 1, 2011)

A short and quick overview on how to export your layouts to EPUB in InDesign CS5.

[Exporting to EPUB for the Apple iBookstore \(PDF, 2.5 MB\)](#)

article (Jan. 1, 2011)

Learn how to create an EPUB for the Apple iBook store

[Folio Producer Tools \(video 1:04\)](#)

video-tutorial (Jan. 1, 2011)

An very short overview of Folio Producer tools for Digital Publishing.

Export content for EPUB | CC

- [Overview](#)
- [Export to EPUB](#)
- [EPUB Export options](#)
- [EPUB resources](#)

[To the top](#)

Overview

Before you export your layout to EPUB, you can make a few tweaks to ensure that it exports properly.

- **Add anchored graphics** - Anchor graphics in text flows so that you can control their position relative to the exported text. See [Anchored Objects](#).
- **Object Export Options** - Specify export options for placed objects. See [Object Export Options](#).
- **Choose content and order** - Use the Articles panel to choose the content to export and order in which it should appear. See [Articles](#). You can also order content based on page layout or the XML structure.

[To the top](#)

Export to EPUB

You can export a document or book as a reflowable eBook in EPUB format that is compatible with eBook reader software.

1. Do one of the following:
 - Open the document and choose File > Export.
 - Open a book and from the Book panel menu, choose Export Book to EPUB.
2. Specify a filename and location.
3. From the Save as Type list choose EPUB, and then click Save.
4. In the EPUB Export Options dialog box, specify the desired options in the General, Image, and Advanced areas, and then click OK.

InDesign creates a single .epub file containing the XHTML-based content. If specified, the exported file may include a cover image. The cover image is created from an image, or created by rasterizing the first page in the specified document (or the style source document if a book was selected). The thumbnail is used to depict the book in the EPUB readers or the Digital Editions Reader library view. To view the file, you need an EPUB reader. You can also use the Adobe Digital Editions software, which you can download free from the Adobe website.

 *The .epub file is essentially a .zip file. To view and edit the contents of an EPUB file, change the extension from .epub to .zip, and then extract the contents. This is especially useful for editing the CSS file.*

Note: InDesign objects such as text frames and objects that contain placed images are always exported when you choose the Based on Page Layout ordering option. Empty objects are not exported unless you have applied a setting to the InDesign object via the Object Export Options to make it export as a JPEG, GIF, or PNG.

[To the top](#)

EPUB Export options

EPUB General options

The General section of the EPUB Export Options dialog box includes the following options.

Version Specify a version for the EPUB.

EPUB 2.0.1 EPUB 2.0.1 is a standard approved by IDPF in 2007. This format is supported on a wide variety of devices.

EPUB 3.0 EPUB 3.0 is a standard approved by IDPF in 2011. This format also supports audio, video, javascript, Japanese vertical text. The new features however will not work on readers and devices that do not support EPUB 3.0 standard.

Cover Specifies the cover image for the eBook. Choose one of the following:

None If this option is selected no cover image is added to the eBook.

Rasterize First Page If this option is selected creates an image file by rasterizing the first page of the eBook to use as the cover.

Choose image If this option is selected you can specify an image on your computer to use as the cover.

Navigation Specify navigation option for EPUB Viewer TOC: either you can use a TOC style to create the sidebar navigation or use the filename.

File Name Select this option if you want to generate a table of contents based on the filenames. For creating a TOC by filename, you must also specify a paragraph style on which you want to split the exported file (Advanced > Split Document > select a style).

TOC Style Select this option if you want to generate a table of contents based on the selected TOC style. From the TOC Style menu, specify the TOC style you want to use to build the table of contents in the eBook. You can choose Layout > Table Of Contents Styles to create a special TOC style for your eBook.

Margins Specify values for the Top, Bottom, Left, and Right margins in pixels. To use the same value for each margin, click the Constrain icon.

Content Order Specify the order in which page elements are exported

Based on Page Layout The location of the items on the page determines the reading order.

If Based On Page Layout is selected, InDesign determines the reading order of page objects by scanning left to right and top to bottom. In some instances, especially in complex, multicolumn documents, the design elements may not appear in the desired reading order. Use Dreamweaver to rearrange and format the contents.

(Asian versions only) If Based On Page Layout is selected, InDesign determines the reading order of page objects according to the document's binding (left to right or right to left). In some instances, especially in complex, multicolumn documents, the exported design elements may not appear in the desired reading order. Use Dreamweaver to rearrange and format the contents.

Same as XML Structure The order of the tags in Structure View determines the reading order. See [Tag page items](#).

Same as Articles panel The order of elements in the Articles panel determines the reading order. Only the checked articles are exported. See Include articles for export.

Place Footnote After Paragraph Check to place footnotes after the paragraph. If deselected, footnotes are converted to endnotes.

Remove Forced Line Breaks Check to remove all soft-returns in the exported eBook.

Bullets Select Map To Unordered List to convert bullet paragraphs into List Items, which are formatted in HTML using the tag. Select Convert To Text to format using the <p> tag with bullet characters as text. If you have used native InDesign auto-bullets, subbullets are also included.

Numbers Determines how numbers are converted in the HTML file. If you have used native InDesign auto-numbering, subbullets are also included

Map To Ordered List Converts numbered lists into List Items, which are formatted in HTML using the tag.

Convert To Text Converts numbered lists into paragraphs that begin with the paragraph's current number as text.

View EPUB After Exporting Opens the EPUB in the default application selected for reading EPUB, if present.

EPUB Image options

The Image section of the EPUB Export options dialog box includes the following options. From the Image Conversion menu, determine how images are exported to HTML.

Preserve Appearance from Layout Check to inherit the image object attributes from the layout.

Resolution (ppi) Choose the resolution of the images in pixels per inch (ppi). While operating systems have standardized on either 72 ppi or 96 ppi, mobile devices range from 132 ppi (iPad), to 172 ppi (Sony Reader), to over 300 ppi (iPhone 4). You can choose a ppi value for each object selected. Values include 72, 96, 150 (average for all eBook devices today), and 300.

Image Size Specify if image size must remain fixed or resized relative to the page. Relative to Page Size sets a relative percentage value based on the size of the image relative to the InDesign page width. This option causes the images to rescale proportionally, relative to the width of the reading area.

Image Alignment and Spacing Specify the image alignment - left, center, and right. You can also specify the top and bottom padding.

Insert Page Break Check to insert page breaks with images. Page breaks can be inserted Before Image, After Image, or Before and After Image.

Settings Apply to Anchored Objects Check to apply these settings to all anchored objects.

Image Conversion Lets you choose whether the optimized images in your document are converted to GIF, JPEG, or PNG. Choose Automatic to let InDesign decide which format to use in each instance. Choosing PNG disables the image compression settings; use PNG for lossless images or for images that include transparency.

GIF Options (Palette) Lets you control how InDesign handles colors when optimizing GIF files. The GIF format uses a limited color palette, which cannot exceed 256 colors.

Choose Adaptive to create a palette using a representative sample of colors in the graphic without any dithering (mixing of small spots of colors to simulate additional colors). Choose Web to create a palette of web-safe colors that are a subset of Windows and Mac OS system colors. Choose System (Win) or System (Mac) to create a palette using the built-in system color palette. This choice may cause unexpected results.

Select Interlace to load the images progressively by filling in missing lines. If this option is not selected, an image looks fuzzy and gradually becomes clear as the image reaches full resolution.

JPEG Options (Image Quality) Determines the trade-off between compression (for smaller file sizes) and image quality for each JPEG image created. Low produces the smallest file and lowest image quality.

JPEG Options (Format Method) Determines how quickly JPEG graphics display when the file containing the image is opened on the web. Choose Progressive to make the JPEG images display gradually and in increasing detail as they are downloaded. (Files created with this option are slightly larger and require more RAM for viewing.) Choose Baseline to make each JPEG file display only after it has been downloaded; a placeholder appears in its place until the file is displayed.

Ignore Object Export Settings Ignore Object Export settings applied on individual images. See [Apply Object export options](#).

EPUB Advanced options

The Contents section of the EPUB Options dialog box includes the following options.

Split Document You can split the eBook at the specified paragraph style. Splitting results in a larger number of HTML files in the EPUB package, but can be helpful for breaking up long files and increases performance in the EPUB readers.

Include Document Metadata The metadata from the document (or the style source document if a book was selected) is included with the exported file.

Publisher Specify the publisher information that appears in the eBook metadata. You can specify a URL for the publisher so that someone who receives the eBook can visit the publisher's website.

Unique ID Every EPUB document requires a unique identifier. A unique identifier is automatically created and displayed. You can remove it and specify a unique identifier.

CSS Options Cascading Style Sheets (CSS) are a collection of formatting rules that control the appearance of content in a web page. When you use CSS to format a page, you separate content from presentation.

Generate CSS Specify whether you want InDesign to generate a CSS for the exported file. If you export your document/book to EPUB without generating a CSS, only the classes associated with the styles are marked in the HTML tags; no overriding classes are created. This is very useful if you want to use an external CSS with the exported file.

Preserve Local Overrides If this option is selected, local formatting such as italic or bold is included.

Include Embeddable Fonts Includes all fonts that are embeddable, in the eBook. Fonts include *embedding bits* that determine if the font is embeddable.

Add Style Sheet Specify the URL of the existing CSS style sheet, which is usually a relative URL, such as "/styles/style.css." InDesign does not check whether the CSS exists or is valid. You can use Dreamweaver to confirm your external CSS setup.

Add Script Specify the URL of an existing JavaScript. InDesign does not check whether the JavaScript exists or is valid, so you'll want to confirm your JavaScript setup.

[To the top](#)

EPUB resources

Use the following links to learn about EPUB format.

- For more information on the EPUB specification, see www.idpf.org.
- Download a free copy of the Digital Editions reader at www.adobe.com/products/digitaleditions.
- See the blog [Digital Editions](#) for information on Digital Editions.
- For information on exporting to Kindle, see the [InDesign to Kindle white paper](#) (PDF).
- Learn how to convert your InDesign files to the EPUB format and start selling your eBooks for viewing on the Apple iPad. See the [InDesign to iPad white paper](#).

Liquid Layouts and Alternate Layouts | CC, CS6

What's covered

Recommended workflow

Liquid layouts

Liquid page rules

Alternate layouts

Create Alternate Layouts

Alternate layouts and Liquid Layout page rules, give you the flexibility to efficiently design for multiple page sizes, orientations, or aspect ratios.

For publishing for multiple formats and sizes, you can choose a design strategy that suits a project best: Hand crafted, semi-automated, or fully automated. The degree of design control decreases as you rely on automated workflows. InDesign provides several enhancements for your adopted strategy to balance cost and control.

Note: Automatic Liquid Layout based-publishing is not possible yet, because of the unavailability of compliant viewer technologies.

[To the top](#)

Recommended workflow

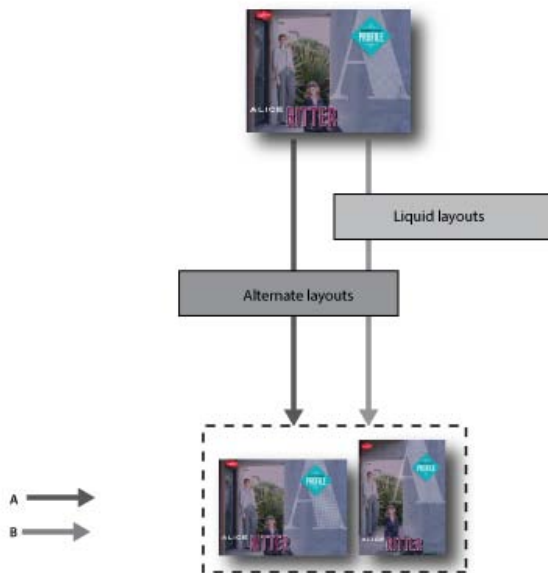

A. Alternate layout workflow **B.** Alternate layout and liquid page rules

STEP 1: Choose a target device and its corresponding dimension and orientation. Then create your primary layout for all the pages.

STEP 2: Optionally, add Adobe Liquid Layout page rules to help adapt content to different aspect ratios and sizes. Liquid page rules are useful if you're targeting multiple devices. Without Liquid page rules, you'll have to manually create a unique layout for every possible size and orientation. See [Liquid layouts](#).

STEP 3: Use the Create Alternate Layout feature to create new pages in the same document. Depending on your primary layout and the Liquid page rules, you may need to manually tune the layout. Repeat this step for each new size and orientation. See [Alternate layouts](#).

[To the top](#)

Liquid layouts



Liquid layouts

Liquid layouts make it easier to design content for multiple page sizes, orientations, or devices. Apply liquid page rules to determine how objects on a page are adapted when you create alternate layouts and change the size, orientation, or aspect ratio.

You can apply different rules to different pages, depending on the layout and the goals; only one liquid page rule can be applied to a page at a time. Liquid Layout is a general term that covers a set of specific liquid page rules: scale, re-center, guide-based, and object-based page rules.

Use Liquid page rules to adapt content for output sizes.

- To adapt layouts when creating new pages in the same document using alternate layouts.
- To adapt layouts when changing existing page sizes. This is more efficient than the previous Layout Adjustment feature.

To apply a liquid page rule, select the Page tool  and click a page. Then choose a liquid page rule from the control bar. You can also use the Layout > Liquid Layouts.

To preview the effects of the applied rule, use the Page tool to drag the page handles to resize the page. The page snaps back to original size when you release it.

 To resize the page, press **Alt** (Windows) or **Option** (Mac OS) and then drag. Using the mouse, however, to resize the page could result in pages that are slightly off the intended size. It's more accurate to resize the page with the Height and Width widgets in the control bar.

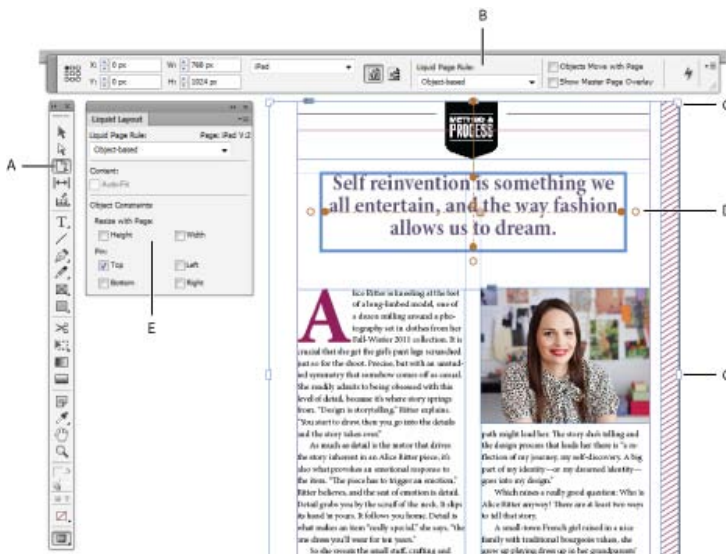

Liquid page rules

A. Page tool **B.** Liquid page rules from control bar **C.** Page handles **D.** Pins for object-based rules **E.** Liquid Layout panel

Liquid page rules

You can apply different rules to different pages. Only one liquid page rule can be applied to a page at a time.

Watch this video to discover how to apply None, Scale, and Recenter rules when resizing a layout. Also learn the meaning behind "Based on

Master." [Using basic Liquid Layout rules: Scale, Recenter, and Based on Master.](#)

Scale All content on the page is treated as a group, and as the page resizes, all the elements scale in proportion. The result is similar to letterboxing or pillarboxing on HD television screens.



Liquid page rules: Scale

Re-center All content on the page is automatically recentered no matter the width. Unlike Scale, the content remains its original size. You can achieve a similar result to video production safe zones using the Re-center rule with careful planning and layout.



Liquid page rules: Re-center

Guide-based Guides define a straight line across the page where content can adapt.

- Whitespace can be added
- Text frames are resized, and the text reflows (but not scale).
- Placed image frames are resized and the cropping boundary dimension of the containing frame resizes.

To add a liquid guide, first select the page tool, then pull out the guides from the ruler.

Guide-based rules are similar to 3-slice and 9-slice scaling in Illustrator, Fireworks, and Flash. Watch this video on [Applying guide-based Liquid Layout rules.](#)

 *To convert a ruler guide to a liquid guide select the page tool and click the Convert to liquid guide icon on the guide. The liquid guide is displayed as a dashed line, while a ruler guide is a solid line.*

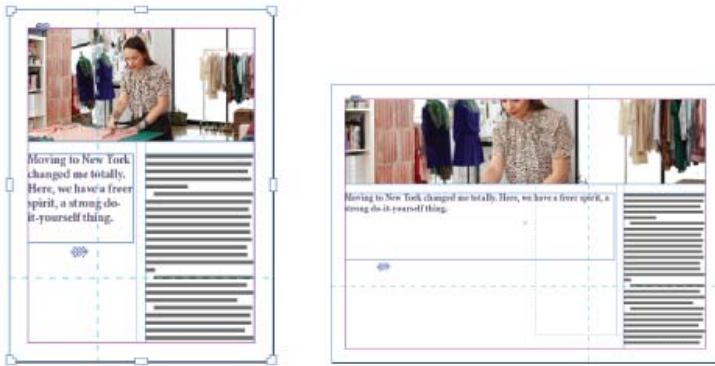

Liquid page rules: Guide-based

Object-based You can specify liquid behavior for size and location relative to the page edge for each object, either fixed or relative.

- Each side of an object's bounding box or frame can either be fixed, or relative to its corresponding page edge. For example, the left side of the frame can have a relationship only with the left edge of the page.
- The height and width can either be fixed, or resizable relative to the page.

Watch this video on [Applying object-based Liquid Layout rules](#).



Liquid page rules: Object-based

[To the top](#)

Alternate layouts

Use Alternate Layouts if you require different page sizes for print or digital publishing within the same document. You can use it to create different sizes of a print advertisement. Or to design the horizontal and vertical layouts for devices such as the Apple iPad or Android tablets.

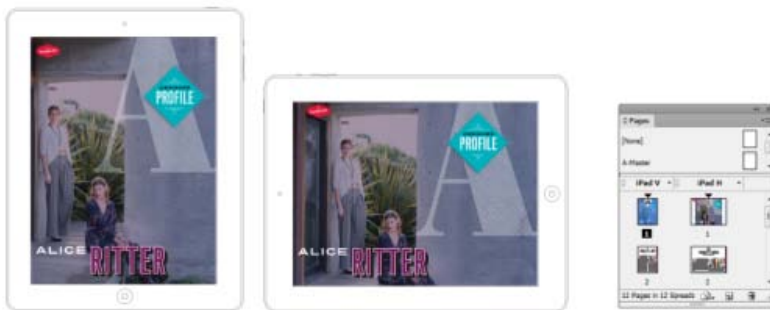

Alternate layouts and Pages panel

Used in combination with Liquid Layout, you can significantly reduce the amount of manual work required to re-layout content for every new page size and orientation.

For a quick overview see [Alternate Layouts](#) video by Lynda.com.

Create Alternate Layouts

To create an alternate layout, do one of the following:

- Choose Layout > Create Alternate Layout
- Choose Create Alternate Layout from the Pages panel menu

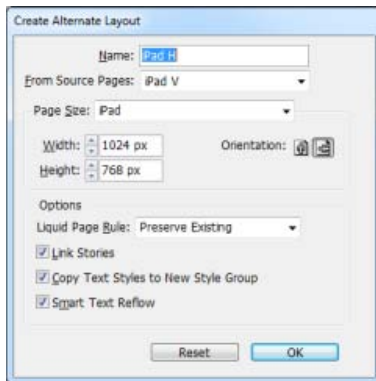

Create Alternate Layouts

In the Create Alternate Layouts dialog box, specify the following options:

Name Enter the name of the alternate layout.

From Source Pages Select the source layout where your content is located.

Page Size Select a page size or enter a custom size for the alternate layout.

Width and Height These fields display the size of the alternate layout. You can enter your own values, but that changes the Page Size to custom.

Orientation Choose an orientation for the alternate layout. If you switch between Portrait and Landscape, the Height and Width are updated.

Liquid Page Rule Choose a liquid page rule to apply to the alternate layout. Select Preserve Existing to inherit the liquid page rules applied to the source pages. Select another rule to apply new liquid page rules.

Link Stories Enable this option to place objects and to link them to the original objects on the source layout. When you update the original object, it is easier to manage updates for linked objects. See [Linked Content](#).

Copy Text Styles to New Style Group Enable this option to copy all text styles, and place them in a new group. This option is useful if you need to vary the text styles between various layouts.

Smart Text Reflow Enable this option to remove any forced line breaks and other style overrides to the text.

Twitter™ and Facebook posts are not covered under the terms of Creative Commons.

[Legal Notices](#) | [Online Privacy Policy](#)

Export content for EPUB | CS5.5

EPUB resources

EPUB General export options

EPUB Images options

EPUB Contents options

You can export a document or book as a reflowable eBook in EPUB format that is compatible with the Adobe Digital Editions reader software, and other eBook reader software.

1. Do one of the following:

- Open the document and choose File > Export.
- Open a book and from the Book panel menu, choose Export Book to EPUB.

2. Specify a filename and location.

3. From the Save as Type list choose EPUB, and then click Save.

4. In the EPUB Export Options dialog box, specify the desired options in the General, Image, and Contents areas.

InDesign creates a single .epub file containing the XHTML-based content. If specified, the exported file may include a cover image. The cover image is created from an image, or created by rasterizing the first page in the specified document (or the style source document if a book was selected). The thumbnail is used to depict the book in the EPUB readers or the Digital Editions Reader library view. To view the file, you need an EPUB reader. You can also use the Adobe Digital Editions software, which you can download free from the Adobe website.

 *The .epub file is essentially a .zip file. To view and edit the contents of an .EPUB file, change the extension from .epub to .zip, and then extract the contents. This is especially useful for editing the CSS file.*

Note: *InDesign objects such as text frames and objects that contain placed images, are always exported when you choose the Based on Page Layout ordering option. Empty objects are not exported unless you have applied a setting to the InDesign object via the Object Export Options to make it export as a JPEG, GIF, or PNG.*

[To the top](#)

EPUB resources

Use the following links to learn about EPUB format.

- For more information on the EPUB format, see www.idpf.org.
- Download a free copy of the Digital Editions reader at www.adobe.com/products/digitaleditions.
- See the blog [Digital Editions](#) for information on Digital Editions.
- For information on exporting to Kindle, see the [InDesign to Kindle white paper](#).
- Learn how to convert your InDesign files to the EPUB format and start selling your eBooks for viewing on the Apple iPad. See the [InDesign to iPad white paper](#).

[To the top](#)

EPUB General export options

The General section of the EPUB Export Options dialog box includes the following options.

Include Document Metadata The metadata from the document (or the style source document if a book was selected) is included with the exported file.

Add Publisher Entry Specify the publisher information that appears in the eBook metadata. You can specify a URL for the publisher so that someone who receives the eBook can visit the publisher's website.

Unique Identifier Every EPUB document requires a unique identifier. You can specify the unique identifier attribute. If you leave this field empty, a unique identifier is automatically created.

EPUB Cover Specifies the cover image for the eBook. Choose one of the following:

No Cover Image If this option is selected no cover image is added to the eBook.

Rasterize First Page If this option is selected creates an image file by rasterizing the first page of the eBook to use as the cover.

Use Existing Image File If this option is selected you can specify an image on your computer to use as the cover.

Ordering lets you specify the order in which the page elements are exported.

Base On Page Layout

The location of the items on the page determines the reading order.

If Base On Page Layout is selected, InDesign determines the reading order of page objects by scanning left to right and top to bottom. In some instances, especially in complex, multicolumn documents, the design elements may not appear in the desired reading order. Use Dreamweaver to rearrange and format the contents.

(Asian versions only) If Base On Page Layout is selected, InDesign determines the reading order of page objects according to the document's binding (left to right or right to left). In some instances, especially in complex, multicolumn documents, the exported design elements may not appear in the desired reading order. Use Dreamweaver to rearrange and format the contents.

Same As XML Structure

The order of the tags in Structure View determines the reading order. See [Tag page items](#).

Same As Articles Panel

The order of elements in the Articles panel determines the reading order. Only the checked articles are exported. See [Include articles for export](#).

Book Margin Specify a simple margin in Ems or pixels. Specifying margins in Ems is better for multiscreen compatibility. The same value is applied to all margins: top, bottom, left, and right.

Bullets Select Map To Unordered List to convert bullet paragraphs into List Items, which are formatted in HTML using the tag. Select Convert To Text to format using the <p> tag with bullet characters as text. If you have used native InDesign auto-bullets, subbullets are also included.

Numbers Determines how numbers are converted in the HTML file. If you have used native InDesign auto-numbering, subbullets are also included

Map To Ordered List Converts numbered lists into List Items, which are formatted in HTML using the tag.

Map To Static Ordered List Converts numbered lists into List Items, but assigns a <value> attribute based on the paragraph's current number in InDesign.

Convert To Text Converts numbered lists into paragraphs that begin with the paragraph's current number as text.

View EPUB After Exporting Starts the Adobe Digital Editions Reader, if present.

EPUB Images options

The Images section of the Digital Editions Export Options dialog box includes the following options. From the Image Conversion menu, determine how images are exported to HTML.

Preserve Appearance from Layout Check to inherit the image object attributes from the layout.

Resolution (ppi) Specify the resolution of the images in pixels per inch (ppi). While operating systems have standardized on either 72 ppi or 96 ppi, mobile devices range from 132 ppi (iPad), to 172 ppi (Sony Reader), to over 300 ppi (iPhone 4). You can specify a ppi value for each object selected. Values include 72, 96, 150 (average for all eBook devices today), and 300.

Image Size Specify if image size must remain fixed or resized relative to the page. Relative to Page Size sets a relative percentage value based on the size of the image relative to the InDesign page width. This option causes the images to rescale proportionally, relative to the width of the reading area.

Image Alignment and Spacing Specify the image alignment, left, center, right, and the top and bottom padding.

Insert Page Break Check to insert page breaks with images. Page breaks can be inserted Before Image, After Image, or Before and After Image.

Settings Apply to Anchored Objects Check to apply these settings to all anchored objects.

Image Conversion Lets you choose whether the optimized images in your document are converted to GIF, JPEG, or PNG. Choose Automatic to let InDesign decide which format to use in each instance. Choosing PNG disables the image compression settings.; use PNG for lossless images or for images that include transparency.

GIF Options (Palette) Lets you control how InDesign handles colors when optimizing GIF files. The GIF format uses a limited color palette, which cannot exceed 256 colors.

Choose Adaptive to create a palette using a representative sample of colors in the graphic without any dithering (mixing of small spots of colors to simulate additional colors). Choose Web to create a palette of web-safe colors that are a subset of Windows and Mac OS system colors. Choose System (Win) or System (Mac) to create a palette using the built-in system color palette. This choice may cause unexpected results.

Select Interlace to load the images progressively by filling in missing lines. If this option is not selected, an image looks fuzzy and gradually becomes clear as the image reaches full resolution.

JPEG Options (Image Quality) Determines the trade-off between compression (for smaller file sizes) and image quality for each JPEG image created. Low produces the smallest file and lowest image quality.

JPEG Options (Format Method) Determines how quickly JPEG graphics display when the file containing the image is opened on the web. Choose Progressive to make the JPEG images display gradually and in increasing detail as they are downloaded. (Files created with this option are slightly larger and require more RAM for viewing.) Choose Baseline to make each JPEG file displays only after it has been downloaded; a placeholder appears in its place until the file displays.

Ignore Object Conversion Settings Ignores Object Export Options applied on individual images. See [Apply Object export options](#).

EPUB Contents options

The Contents section of the EPUB Options dialog box includes the following options.

Format For EPUB Content Specify whether you want to use the XHTML or DTBook format. DTBook is a specialized format that is intended for sight impaired end readers.

Use InDesign TOC Style Select this option if you want to generate a table of contents based on the selected TOC style. From the TOC Style menu, specify the TOC style you want to use to build the table of contents in the eBook. You can choose Layout > Table Of Contents Styles to create a special TOC style for your eBook.

Break Document at Paragraph Style You can split the eBook at the specified paragraph style. Splitting results in a larger number of HTML files in the EPUB package, but can be helpful for breaking up long files and increases performance in the EPUB readers.

Place Footnote After Paragraph Check to place footnotes after the paragraph. If deselected, footnotes are converted to endnotes.

Remove Forced Line Breaks Check to remove all soft-returns in the exported eBook.

Generate CSS Cascading Style Sheets (CSS) are a collection of formatting rules that control the appearance of content in a web page. When you use CSS to format a page, you separate content from presentation.

Include Style Definitions When exporting to EPUB, you can create a list of CSS styles that can be edited.

Preserve Local Overrides If this option is selected, local formatting such as italic or bold is included.

Include Embeddable Fonts Includes all fonts that are embeddable, in the eBook. Fonts include *embedding bits* that determine if the font is embeddable.

Style Names Only Includes only undefined style names in the EPUB style sheet.

Use Existing CSS File Specify the URL of the existing CSS style sheet, which is usually a relative URL, such as “/styles/style.css.” InDesign does not check whether the CSS exists or is valid, so you’ll want to confirm your CSS setup.

 Twitter™ and Facebook posts are not covered under the terms of Creative Commons.

[Legal Notices](#) | [Online Privacy Policy](#)

Export content for EPUB | CS6

Overview

Export to EPUB

EPUB Export options

EPUB General options

EPUB Image options

EPUB Advanced options

EPUB resources

[To the top](#)

Overview

Before you export your layout to EPUB, you can make a few tweaks to ensure that it exports properly.

- **Add anchored graphics** - Anchor graphics in text flows so that you can control their position relative to the exported text. See [Anchored Objects](#).
- **Object Export Options** - Specify export options for placed objects. See [Object Export Options](#).
- **Map styles to export tags** - Map character and paragraph styles to HTML tags and classes. See [Map Styles to export tags](#).
- **Choose content and order** - Use the Articles panel to choose the content to export and order in which it should appear. See [Articles](#). You can also order content based on page layout or the XML structure.

[To the top](#)

Export to EPUB

You can export a document or book as a reflowable eBook in EPUB format that is compatible with eBook reader software.

1. Do one of the following:

- Open the document and choose File > Export.
- Open a book and from the Book panel menu, choose Export Book to EPUB.

2. Specify a filename and location.

3. From the Save as Type list choose EPUB, and then click Save.

4. In the EPUB Export Options dialog box, specify the desired options in the General, Image, and Advanced areas.

InDesign creates a single .epub file containing the XHTML-based content. If specified, the exported file may include a cover image. The cover image is created from an image, or created by rasterizing the first page in the specified document (or the style source document if a book was selected). The thumbnail is used to depict the book in the EPUB readers or the Digital Editions Reader library view. To view the file, you need an EPUB reader. You can also use the Adobe Digital Editions software, which you can download free from the Adobe website.

 *The .epub file is essentially a .zip file. To view and edit the contents of an EPUB file, change the extension from .epub to .zip, and then extract the contents. This is especially useful for editing the CSS file.*

Note: InDesign objects such as text frames and objects that contain placed images are always exported when you choose the Based on Page Layout ordering option. Empty objects are not exported unless you have applied a setting to the InDesign object via the Object Export Options to make it export as a JPEG, GIF, or PNG.

EPUB Export options

EPUB General options

The General section of the EPUB Export Options dialog box includes the following options.

Version Specify a version for the EPUB.

EPUB 2.0.1 EPUB 2.0.1 is a standard approved by IDPF in 2007. This format is supported on a wide variety of devices.

EPUB 3.0 EPUB 3.0 is a standard approved by IDPF in 2011. This format also supports audio, video, javascript, Japanese vertical text. The new features however will not work on readers and devices that do not support EPUB 3.0 standard.

EPUB 3.0 with Layout This is an experimental format created by Adobe Systems. It supports multiple-columns, text wrap, and other controls so that your layouts look good on all layouts. This feature will only work with specific viewer technologies.

Cover Specifies the cover image for the eBook. Choose one of the following:

None If this option is selected no cover image is added to the eBook.

Rasterize First Page If this option is selected creates an image file by rasterizing the first page of the eBook to use as the cover.

Choose image If this option is selected you can specify an image on your computer to use as the cover.

TOC Style Select this option if you want to generate a table of contents based on the selected TOC style. From the TOC Style menu, specify the TOC style you want to use to build the table of contents in the eBook. You can choose Layout > Table Of Contents Styles to create a special TOC style for your eBook.

Margins Specify values for the Top, Bottom, Left, and Right margins in pixels. To use the same value for each margin, click the Constrain icon.

Content Order Specify the order in which page elements are exported

Based on Page Layout The location of the items on the page determines the reading order.

If Based On Page Layout is selected, InDesign determines the reading order of page objects by scanning left to right and top to bottom. In some instances, especially in complex, multicolumn documents, the design elements may not appear in the desired reading order. Use Dreamweaver to rearrange and format the contents.

(Asian versions only) If Based On Page Layout is selected, InDesign determines the reading order of page objects according to the document's binding (left to right or right to left). In some instances, especially in complex, multicolumn documents, the exported design elements may not appear in the desired reading order. Use Dreamweaver to rearrange and format the contents.

Same as XML Structure The order of the tags in Structure View determines the reading order. See [Tag page items](#).

Same as Articles panel The order of elements in the Articles panel determines the reading order. Only the checked articles are exported. See Include articles for export.

Place Footnote After Paragraph Check to place footnotes after the paragraph. If deselected, footnotes are converted to endnotes.

Remove Forced Line Breaks Check to remove all soft-returns in the exported eBook.

Bullets Select Map To Unordered List to convert bullet paragraphs into List Items, which are formatted in HTML using the tag. Select Convert To Text to format using the <p> tag with bullet characters as text. If you have used native InDesign auto-bullets, subbullets are also included.

Numbers Determines how numbers are converted in the HTML file. If you have used native InDesign auto-numbering, subbullets are also included

Map To Ordered List Converts numbered lists into List Items, which are formatted in HTML using the tag.

Map To Static Ordered List Converts numbered lists into List Items, but assigns a <value> attribute based on the paragraph's current number in InDesign.

Convert To Text Converts numbered lists into paragraphs that begin with the paragraph's current number as text.

View EPUB After Exporting Opens the EPUB in the default application selected for reading EPUB, if present.

EPUB Image options

The Images section of the EPUB Export options dialog box includes the following options. From the Image Conversion menu, determine how images are exported to HTML.

Preserve Appearance from Layout Check to inherit the image object attributes from the layout.

Resolution (ppi) Choose the resolution of the images in pixels per inch (ppi). While operating systems have standardized on either 72 ppi or 96 ppi, mobile devices range from 132 ppi (iPad), to 172 ppi (Sony Reader), to over 300 ppi (iPhone 4). You can choose a ppi value for each object selected. Values include 72, 96, 150 (average for all eBook devices today), and 300.

Image Size Specify if image size must remain fixed or resized relative to the page. Relative to Page Size sets a relative percentage value based on the size of the image relative to the InDesign page width. This option causes the images to rescale proportionally, relative to the width of the reading area.

Image Alignment and Spacing Specify the image alignment, left, center, right, and the space before and space after.

Insert Page Break Check to insert page breaks with images. Page breaks can be inserted Before Image, After Image, or Before and After Image.

Settings Apply to Anchored Objects Check to apply these settings to all anchored objects.

Image Conversion Lets you choose whether the optimized images in your document are converted to GIF, JPEG, or PNG. Choose Automatic to let InDesign decide which format to use in each instance. Choosing PNG disables the image compression settings; use PNG for lossless images or for images that include transparency.

GIF Options (Palette) Lets you control how InDesign handles colors when optimizing GIF files. The GIF format uses a limited color palette, which cannot exceed 256 colors.

Choose Adaptive to create a palette using a representative sample of colors in the graphic without any dithering (mixing of small spots of colors to simulate additional colors). Choose Web to create a palette of web-safe colors that are a subset of Windows and Mac OS system colors. Choose System (Win) or System (Mac) to create a palette using the built-in system color palette. This choice may cause unexpected results.

Select Interlace to load the images progressively by filling in missing lines. If this option is not selected, an image looks fuzzy and gradually becomes clear as the image reaches full resolution.

JPEG Options (Image Quality) Determines the trade-off between compression (for smaller file sizes) and image quality for each JPEG image created. Low produces the smallest file and lowest image quality.

JPEG Options (Format Method) Determines how quickly JPEG graphics display when the file containing the image is opened on the web. Choose Progressive to make the JPEG images display gradually and in increasing detail as they are downloaded. (Files created with this option are slightly larger and require more RAM for viewing.) Choose Baseline to make each JPEG file display only after it has been downloaded; a placeholder appears in its place until the file is displayed.

Ignore Object Conversion Settings Ignores Object Export Options applied on individual images. See [Apply Object export options](#).

EPUB Advanced options

The Contents section of the EPUB Options dialog box includes the following options.

Split Document You can split the eBook at the specified paragraph style. Splitting results in a larger number of HTML files in the EPUB package, but can be helpful for breaking up long files and increases performance in the EPUB readers.

Include Document Metadata The metadata from the document (or the style source document if a book was selected) is included with the exported file.

Publisher Specify the publisher information that appears in the eBook metadata. You can specify a URL for the publisher so that someone who receives the eBook can visit the publisher's website.

Unique ID Every EPUB document requires a unique identifier. A unique identifier is automatically created and displayed. You can remove it and specify a unique identifier.

CSS Options Cascading Style Sheets (CSS) are a collection of formatting rules that control the appearance of content in a web page. When you use CSS to format a page, you separate content from presentation.

Include Style Definitions When exporting to EPUB, you can create a list of CSS styles that can be edited.

Preserve Local Overrides If this option is selected, local formatting such as italic or bold is included.

Include Embeddable Fonts Includes all fonts that are embeddable, in the eBook. Fonts include *embedding bits* that determine if the font is embeddable.

Add Style Sheet Specify the URL of the existing CSS style sheet, which is usually a relative URL, such as "/styles/style.css." InDesign does not check whether the CSS exists or is valid, so you'll want to confirm your CSS setup.

Add Script Specify the URL of an existing JavaScript. InDesign does not check whether the JavaScript exists or is valid, so you'll want to confirm your JavaScript setup.

[To the top](#)

EPUB resources

Use the following links to learn about EPUB format.

- For more information on the EPUB specification, see www.idpf.org.
- Download a free copy of the Digital Editions reader at www.adobe.com/products/digitaleditions.
- See the blog [Digital Editions](#) for information on Digital Editions.
- For information on exporting to Kindle, see the [InDesign to Kindle white paper](#) (PDF).
- Learn how to convert your InDesign files to the EPUB format and start selling your eBooks for viewing on the Apple iPad. See the [InDesign to iPad white paper](#).



Twitter™ and Facebook posts are not covered under the terms of Creative Commons.

[Legal Notices](#) | [Online Privacy Policy](#)

Digital Publishing Suite overview

Digital Publishing Suite overview

[To the top](#)

Digital Publishing Suite overview

The Adobe Digital Publishing Suite is a set of tools and hosted services that lets publishers create and distribute publications on tablet devices such as the Apple iPad. These digital publications are called *folios*.

With InDesign, you can create folios and preview them on a tablet device and on a desktop previewer. However, a subscription to the Digital Publishing Suite is necessary to build a custom viewer. Publishers can distribute their digital publications by submitting them to the Apple Store or to the Android Market. You can make folios available to a publisher who has a subscription to the Digital Publishing Suite.

The Folio Builder and Overlay Creator panels let you create digital publications for tablet devices.

To access the panels:

Overlay Creator Choose Window > Extensions > Overlay Creator.

Folio Builder Choose Window > Extensions > Folio Builder.

For more information on creating digital publications for tablet devices, see www.adobe.com/go/learn_dps_help_en.

 Twitter™ and Facebook posts are not covered under the terms of Creative Commons.

[Legal Notices](#) | [Online Privacy Policy](#)

Articles (CS5.5)

[Introduction to articles](#)

[Create an article and add content to it](#)

[Add all page items in a document to an article](#)

[Managing articles](#)

[Include articles for export](#)

[To the top](#)

Introduction to articles

Articles provide an easy way to create relationships among page items. These relationships can be used to define the content to be exported to EPUB, HTML, or Accessible PDFs; and to define the order of the content. You can create articles from a combination of existing page items within a layout, including images, graphics, or text. Once an article has been created, page items can be added, removed, or reordered. Articles can be created manually by dragging one or more page items to an article in the Articles panel.

You can also add bulk content to an article. Adding selected content to selected article, or adding an entire document content to an article is supported.

Note: *The XML structure panel provides another mechanism to decide the order of the content to be exported to the ePub, HTML, and Accessible PDF exports workflows. The Articles panel is designed to be simpler, easier to use, and more accessible, for people without XML skills. However, the ability to use the XML structure panel has not been removed; it is now an option alongside the use of the Articles panel during the export process. See [Structuring documents for XML](#).*

[To the top](#)

Create an article and add content to it

1. Choose Window > Articles to open the Articles panel.

2. Select the page items to add to the article.

 *To create an empty article, don't select a page item in the layout.*

3. Do one of the following:

- Choose New Article from the Articles panel menu.
- Click Create New Article  at the bottom of the Articles panel.
- Drag story or page element to the Articles panel.

4. In the New Article dialog box, enter a name for the article.

5. Select Include When Exporting to add the article to the EPUB/HTML export output.

[To the top](#)

Add all page items in a document to an article

To add all the page items to an article:

1. Choose Window > Articles to open the Articles panel.
2. Select an article to add the items to. If you don't select an article, a new article is created.
3. Press Command (Mac OS) or Ctrl (Windows) and then click the  in the Articles panel.
4. If a New Article dialog box opens, enter a name for the article.
5. Select Include When Exporting to add the article to the EPUB/HTML export.

 *If you've selected an article, choose Add Document Content to Selected Articles from the articles panel menu.*

[To the top](#)

Managing articles

You can manage articles using the Articles panel. You can drag page elements into the Articles panel to add them to an article. Drag items in the Articles panel to change the order, or move them from one article to another.

The Articles panel pop-up menu also provides options to manage content.

[To the top](#)

Include articles for export

You can create articles and select which articles to include while exporting to EPUB or HTML. By default, all articles are selected for export.

To include an article while exporting, in the Articles panel, select the article and do one of the following:

- Select the check box next to the article.
- Choose Article Options from the Articles panel pop-up menu and then select Include When Exporting.

 Twitter™ and Facebook posts are not covered under the terms of Creative Commons.

[Legal Notices](#) | [Online Privacy Policy](#)

Automation

Scripting

[Scripting in InDesign](#)
[Scripts panel and Script Label panel overview](#)
[Running sample scripts](#)

[To the top](#)

Scripting in InDesign

Scripting is a great tool for performing a variety of tasks. A script can be as simple as an automated common task or as complex as an entire new feature. You can create your own scripts, and you can run scripts that other people have created. For more information on scripting, see the Scripting Guide, scripting requirements, and other developer resources at <http://www.adobe.com/devnet/indesign/documentation.html>.

The Scripting Guide contains an introduction to scripting and tutorials. You can also find a number of useful scripts that you can run, such as a script that draws guides around the selected object. Some of these scripts appear by default in the Scripts panel.

[To the top](#)

Scripts panel and Script Label panel overview

InDesign includes two panels for scripting: the Scripts panel and the Script Label panel.

The Scripts panel is where you run scripts without leaving InDesign. The Scripts panel displays the scripts that are located in the Scripts folders in the InDesign application folder and in your Preferences folders. If you create or receive a script, you can place it in the Scripts Panel folder so that it shows up in the Scripts panel.

Mac OS Users/[username]/Library/Preferences/Adobe InDesign/[version]/[language]/Scripts/Scripts Panel

Windows XP Documents and Settings\[username]\Application Data\Adobe\InDesign\[version]\[language]\Scripts\Scripts Panel

Windows Vista and Windows 7 Users\[username]\AppData\Roaming\Adobe\InDesign\[version]\[language]\Scripts\Scripts Panel

 A quick way to locate the Scripts Panel folder is to right-click (Windows) or Control-click (Mac OS) a script in the Scripts panel, and choose Reveal In Explorer (Windows) or Reveal In Finder (Mac OS).

You can then double-click a script in the Scripts panel to run it, or you can run scripts using Quick Apply.

The Script Label panel lets you specify a label for a page item, such as a text frame or shape. Specifying labels for page items is especially useful for writing scripts in which you need to identify an object.

 For detailed information on adding, running, and editing scripts, see the Scripting Guide on the Adobe website at <http://www.adobe.com/devnet/indesign/documentation.html>.

Open the Scripts panel

- Choose Window > Utilities > Scripts.

Open the Script Label panel

- Choose Window > Utilities > Script Label.

Running sample scripts

You can run these scripts in InDesign:

AddGuides Adds guides around the selected object or objects.

AddPoints Adds points to the paths of the selected object or objects.

AdjustLayout Moves objects by specified distances on right/left pages.

AlignToPage Aligns objects to specified positions on a page.

AnimationEncyclopedia Automatically creates buttons with different animation properties.

BreakFrame Removes a selected text frame and its contents from a story.

CornerEffects Re-draws the path of the selected item or items using a variety of corner effects. Corner effects can be applied to selected points on the path.

CreateCharacterStyles Defines a complete character style based on the selected text.

CropMarks Adds crop and/or registration marks around the selected object or objects.

ExportAllStories Exports all stories in a document to a series of text files.

FindChangeByList Performs a series of common text find/change operations by reading a tab-delimited text file.

ImageCatalog Places all graphics in a specified folder in a “contact sheet” layout.

MakeGrid Creates a grid by subdividing or duplicating the selected object or objects.

Neon Applies a “blend” effect to the selected object or objects.

PathEffects Changes the position of path points on the selected object or objects to add a creative effect.

PlaceMultipagePDF Places all pages of a PDF.

SelectObjects Selects objects on the active spread by their object type.

SortParagraphs Sorts the paragraphs in the selection alphabetically.

SplitStory Splits the text frames in the selected story into separate, unlinked text frames.

TabUtilities Applies tab stops and indents to the selected text.

For more information on installing and using these sample scripts, see www.adobe.com/go/learn_id_scripting_readme_cs5_en (PDF).

Adobe also recommends

- [Scripting with InDesign](#)



Twitter™ and Facebook posts are not covered under the terms of Creative Commons.

[Legal Notices](#) | [Online Privacy Policy](#)

Plug-ins

Install plug-ins

Use Extension Manager to configure plug-ins

[To the top](#)

Install plug-ins

The InDesign plug-in modules are software programs developed by Adobe Systems, and by other software developers working in conjunction with Adobe, to add features to Adobe software. A number of importing, exporting, automation, and special-effects plug-ins come with your program and are automatically installed in the Plug-Ins folder. In fact, most of the features you see in InDesign are provided by plug-ins.

Once installed, plug-in modules appear as options on menus, in dialog boxes, or in panels.

For information on third-party plug-ins, see www.adobe.com/go/learn_id_plugins_en.

1. If an installer is provided, use it to install the plug-in module. Otherwise, drag a copy of the module into the Plug-Ins folder inside the InDesign application folder.
2. Follow any installation instructions that come with the plug-in.

Note: You can use any commercial plug-in designed for use with InDesign. Adobe Technical Support can help you isolate problems related to plug-ins. However, if it has been determined that the problem is directly related to a plug-in created by another company, you will need to contact that company for further support.

[To the top](#)

Use Extension Manager to configure plug-ins

Use the Extension Manager application to inspect and customize the set of installed plug-ins. For example, you can get detailed information about installed plug-ins, create custom plug-in sets for different tasks or workgroups, and isolate plug-ins when troubleshooting problems. You can also disable plug-ins.

- Choose Help > Manage Extensions (Windows) or InDesign > Manage Extensions (Mac OS).

For more information on using Extension Manager, click Help in the Extension Manager application.

 Twitter™ and Facebook posts are not covered under the terms of Creative Commons.

[Legal Notices](#) | [Online Privacy Policy](#)

Data merge

- About data merge
- Basic steps for merging data
- About data source files
- Add image fields in the data source file
- About target documents
- Select a data source
- Insert data fields
- Adding data field placeholders to master pages
- Update, remove, or replace data source files
- Preview records in the target document
- Switching preview on or off
- Edit data field placeholders
- Set content placement options
- Merge records
- Update data fields
- Overset text reports
- Content placement options

[To the top](#)

About data merge

To create form letters, envelopes, or mailing labels, you merge a data source file with a target document. Data merge is also referred to as *mail merge*.

The *data source file* contains the information that varies in each iteration of the target document, such as the names and addresses of the recipients of a form letter. A data source file is made up of *fields* and *records*. *Fields* are groups of specific information, such as company names or postal codes, whereas *records* are rows of complete sets of information, such as a company's name, street address, city, state, and postal code. A data source file can be a comma-delimited file (.csv) or a tab-delimited (.txt) file in which each piece of data is separated by a comma or a tab, respectively.

The *target document* is an InDesign document that contains the data-field placeholders, plus all the boilerplate material, text, and other items that remain the same in each iteration of the merged document.

The *merged document* is the resulting InDesign document that contains the boilerplate information from the target document, repeated as many times as it takes to accommodate each record from the data source.

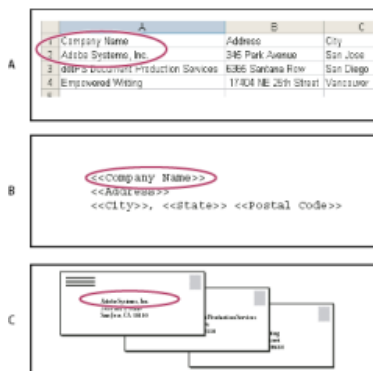

Data merge

A. Data source file B. Target document C. Merged document

[To the top](#)

Basic steps for merging data

1. Make plans to determine which data fields you'll be using in your source and target documents.

Determine how you want the final document to look, so that you know which fields are necessary to accomplish the merge. For example, if you are creating a postcard that will be mailed to customers, you might want to use the following data fields:

<<Company Name>><<Address>><<City>>, <<State>><<Postal Code>>

Your spreadsheet or database might look like this:

	A	B	C
1	Company Name	Address	City
2	Adobe Systems, Inc.	345 Park Avenue	San Jose
3	edPS Document Production Services	6365 Sattara Row	San Diego
4	Empowered Writing	17404 NE 25th Street	Vancouver

Sample data file

2. Save the data source file—usually a spreadsheet or database file—as a comma-delimited (.csv) or tab-delimited (.txt) text file.

Make sure that your data source file is structured in such a way that you can include the appropriate fields in your target document. For example, the top row of a spreadsheet should contain the field names that you'll use in the target document, such as “Company” and “Address.”

For more information, see [About data source files](#).

3. Create a target document that includes text and other items that remain the same in each version of the target document.

For more information, see [About target documents](#).

4. Select the data source using the Data Merge panel.

For more information, see [Select a data source](#).

5. Insert fields from the Data Merge panel into the target document.

You can add data fields to either a document page or a master page. If you add data fields to a master page, you have additional options.

For more information, see [Insert data fields](#) and [Adding data field placeholders to master pages](#).

6. Preview the records to make sure that the target document will look the way you intend.

For more information, see [Preview records in the target document](#).

7. Merge the target document with the data source file, or export to PDF.

For more information, see [Merge records](#).

[To the top](#)

About data source files

The data source typically originates from a spreadsheet or database application, but you can create your own data source file using InDesign or any text editor. Data source files should be saved in a comma-delimited (.csv) or tab-delimited (.txt) text format. Check your source application's user guide for more information on exporting to these formats.

In a comma- or tab-delimited text file, records are separated by paragraph breaks; fields are separated by commas or tabs. The data source file can also include text or paths that refer to images on disk.

Example of comma-delimited data source file

Name,Company Name,State
Bill Tucker,CoreVent Labs,Nevada
Dat Nguyen,"Brady, Hunt, and Baxter, Inc",Delaware
Maria Ruiz,"Brinquist Enterprises, Inc.",California

 If you want to include a comma or quotation mark in a comma-delimited file, enclose the text within quotation marks, such as "Brady, Hunt, and Baxter, Inc.". If you do not include the quotation marks, each name is treated as a separate field.

You cannot insert a line break within a field in the data source file. If it's necessary to split a field across different lines, create two different fields, such as <<Address1>> and <<Address2>>.

You can choose Remove Blank Lines For Empty Fields when merging the document to prevent empty lines. However, if any characters, including spaces, appear on the line, the line is not deleted.

[To the top](#)

Add image fields in the data source file

By adding image fields to the data source file, you can allow a different image to appear on each merged record. For example, when you merge documents that include information from various companies, you may want to include an image of each company's logo as part of the merge.

1. Open the data source file.
2. At the beginning of the data field name, type an "at" symbol (@) to insert text or paths that refer to image files.

The @ symbol is required only in the first line; subsequent lines should include the image paths. Paths, which are case-sensitive, must follow the naming conventions of the operating system in which they're stored.

 If you get an error message when you type the @ symbol at the beginning of the field, type an apostrophe (') before the @ symbol (such as '@Photos') to validate the function. Some applications, such as Microsoft Excel, reserve the @ symbol for functions.

(Windows) Example of image references in data source file

Name	Age	@Photos
Bill Tucker	36	C:\Photos\BillTucker.jpg
Dat Nguyen	53	C:\MyDocuments\dat.gif
Maria Ruiz	26	C:\Photos\Ruiz.psd

(Mac OS) Example of image references in data source file

Name	Age	@Photos
Bill Tucker	36	Mac HD:Photos:BillTucker.jpg
Dat Nguyen	53	Desktop:Family:dat.gif
Maria Ruiz	26	Mac HD:Photos:Ruiz.psd

 You can use InDesign to view the path of an image on your operating system. Insert an image in an InDesign document, and then use the Links panel to view the image's location. With the image selected, choose Copy Info > Copy Full Path from the Links panel menu. You may need to edit the path after you paste it in your data source. This technique is especially useful for images on a server.

About target documents

Once your data source file is created, you need to set up the target document and insert the fields from the data source file. The target document contains data-field placeholder text and graphics, such as the design that you want to appear on every postcard. These fields become available to add after you select a data source.



The target document includes fields from the data source with field placeholder text shown.

When you merge data, InDesign creates a new document that replaces the fields with the data you designated in the data source file. You can place data fields on either a master page or a document page.

Select a data source

Before you insert fields into your target document, select a data source in the Data Merge panel. You can have only one data source file selected per target document.

1. Create or open the document you'll be using as the target document.
2. Choose Window > Utilities > Data Merge.
3. Choose Select Data Source from the Data Merge panel menu.
4. To change delimited text options, select Show Import Options.

InDesign automatically detects the type of delimiter and encoding used in the data source file, so showing the import options usually isn't necessary. However, you can specify different encoding and delimiter options if you think they haven't been correctly identified.

5. Locate the data source file, and click Open.
6. If you selected Show Import Options, change the delimiter and encoding options as necessary, and then click OK. The data fields appear in the Data Merge panel.

Note: If an alert message indicates that it cannot open the file, or if incorrect fields appear in the list box, you may need to edit the spreadsheet or database file and save it as a comma-delimited or tab-delimited file.

Once the data source is selected and fields are loaded in the Data Merge panel, any changes made to the data source are not reflected in the target document until you update the data source.

Insert data fields

When you select the data source, a list of data field names appears in the Data Merge panel. These names are identical to the column heads from the data source file. Icons indicate whether the field is text or an image. When data fields are added to your document, they become field placeholders, such as <<Company>>. You can select and format these placeholders as you would any other text or graphic.

You can assign an image field to an existing frame to create a floating image. Or, if the insertion point is in a text frame or if text is selected when you insert an image field, a small placeholder is inserted as an inline frame. You can resize the image placeholder to determine the size of the merged images.

Once you insert a data field, InDesign remembers its data source. Any errors in the list of fields, such as typos, empty fields, and unintended field types, must be corrected in the source application and then updated using the Data Merge panel.

Insert a text data field in the target document

1. Create a text frame on a document page or master page.

If you're adding data fields to a master page, see [Adding data field placeholders to master pages](#).

2. Place the insertion point in the text frame where you want the field placeholder to appear, or select the text you want to replace.

3. To insert a field placeholder, do one of the following:

- Click a field in the Data Merge panel list.
- Drag a field name from the Data Merge panel list, and drop it onto the text frame to add the placeholder. If you drag a text field onto an empty frame, the empty frame becomes a text frame.

Text field placeholders appear in the target application within double angle brackets (such as <<Name>>) using the current formatting attributes (such as font and size).

Note: You cannot create a valid field by simply typing the field name or editing an existing field. You must insert it from the Data Merge panel.

Insert an image data field in the target document

- To insert a new inline graphic placeholder, drag an image field onto a text frame, or place the insertion point in a text frame and click the image field.
- To insert a new floating graphic, drag an image field onto an empty frame or existing graphics frame. If you drag an image field onto an empty frame, the empty frame becomes a graphics frame.
- To insert a field into grouped items, table cells, or nested items, drag the image field onto the target.

Image field placeholders appear as frames containing the field name.

[To the top](#)

Adding data field placeholders to master pages

If you insert data field placeholders on master pages, you have advantages that are not available when you insert placeholders on document pages:

- The resulting merged document contains the original placeholders on its master pages and includes the merged results on document pages as overridden master page items.
- The merged document maintains a connection to the data source, so if records in the data source are modified, you can update the merged document contents by choosing Update Content In Data Fields. This option is especially helpful if you change the layout in the merged document and then need to add new data from the data source.
- The settings in the Create Merged Document dialog box are the same as those used in the target document, so you can quickly re-create the current document with the same appearance. You can also use these shared settings to create an identical document with a different data source, or create a new document with a slightly modified layout.

Note: If you're adding data fields to a master page, make sure that the text frame containing the data fields allows master item overrides. Select the text frame on the master page and choose Allow Master Item Overrides On Selection from the Pages panel menu. If this option is not selected,

the data will not be merged. (See *Create masters.*)

You cannot place data fields on both master pages and document pages. In order to merge properly, you must apply a master containing data fields to the first page of the document.

Note: If an error message indicates that InDesign cannot merge the document because no placeholders are present, you may have added the placeholders to the left master page in a one-page document. Page 1 is based on the right master page, so add the placeholders to the right master page.

[To the top](#)

Update, remove, or replace data source files

- To update data source files, edit and save the data source file in comma- or tab-delimited format, and then choose Update Data Source from the Data Merge panel.

The changes will be reflected in the Data Merge panel. If the changes are not reflected in the document after updating, deselect Preview to turn it off, and then select Preview again to turn it back on.

- To remove the connection to the data source file, choose Remove Data Source from the Data Merge panel menu.
- To switch to a new data source file, choose Select Data Source from the Data Merge panel menu, and then specify the new data source file. InDesign may not recognize some of the fields. In this situation, it's best to delete and reinsert placeholder fields.

 If you generate a merged document from a target document in which data fields appeared on master pages, you can update the data fields in the merged document.

[To the top](#)

Preview records in the target document

Before you merge the target document and data source file, it's a good idea to preview the records to make sure that field data will appear properly when the information is merged. When you preview records, the Data Merge panel displays actual data from the data source file instead of the field placeholders. For example, instead of seeing <<Company>>, you might see *Adobe Systems, Inc.* You can use the navigation buttons on the Data Merge panel to cycle through the records.

If you find problems with any of the records, such as typographical errors or extra spaces, it is recommended that you edit the source file in its original application. (See [About data source files.](#))

1. Click Preview at the bottom of the Data Merge panel, or choose Preview from the Data Merge panel menu.
2. Click the navigation buttons to cycle through data from different records.

 To go to a specified record, click the navigation buttons at the bottom of the panel. You can also type the number of the record you want to preview in the navigation text box at the bottom of the panel, and then press Enter or Return.

[To the top](#)

Switching preview on or off

Some issues may arise or correct themselves when you switch between previewing modes. Keep the following in mind:

- Placeholders replace the preview content when the Preview Record option is not selected. If you delete an image as well as the frame containing the image, or delete a whole text string, when you deselect the Preview Record option, the placeholders will not appear as they have also been removed.
- Changes in the Content Placement Options dialog box are not reflected until you click OK. Also, if the Preview Record option is selected, the data will not reflect the updated placement settings until you deselect and select the option again.
- If you try to save the document in preview mode, you will receive a message prompting you to turn off preview mode before saving your document.

Edit data field placeholders

When you add a text data field to a document, the placeholder text for the field is entered using the formatting attributes (such as font and size) active at the insertion point. You can then edit the placeholder text's attributes to control the look of the actual data.

- Do one of the following:
 - To change placeholder attributes, select the placeholder text, and then change the formatting attributes as you would with other text.
 - To change a placeholder, select the placeholder or the actual data, and select a different field name in the Data Merge panel.
 - To delete a placeholder, select the placeholder and press Backspace or Delete.

Note: *In Story Editor view, text placeholders are displayed in the same way as hyperlinks. Some Data Merge panel options are not available in Story Editor view.*

Set content placement options

Use the Content Placement Options dialog box to specify the default settings for the current document or for all future data merge projects. You can specify how the image is placed, whether images are linked or embedded, whether blank lines are removed for empty fields, and the maximum number of records for each merged document.

1. Do one of the following:
 - To affect only the current document, open the target document.
 - To affect all future documents you create, close all documents.
2. Choose Window > Utilities > Data Merge.
3. Choose Content Placement Options from the Data Merge panel menu.
4. Change the content placement options. (See [Content placement options](#).)
5. Click OK.

Merge records

After you format the target document and insert fields from the data source file, you're ready to officially merge the information from the data source with the target document. You can merge the records to another InDesign document or directly to PDF. When you merge, InDesign creates a new document or PDF based on the target document, and replaces the fields in the target document with the appropriate information from the data source file.

When you merge a document that includes data field placeholders on master pages, those master page items will be copied into the master pages in the newly generated document.

Merge single or multiple records

1. With the target document open, do one of the following:

- Choose Create Merged Document from the Data Merge panel menu, or click the Create Merged Document button .
 - Choose Export To PDF from the Data Merge panel menu.
2. On the Records tab, for Records To Merge, select All Records to merge all the records in the data source file, select Single Record to merge a specific record, or specify a Range of records to merge.
 3. For Records Per Document Page, do one of the following:
 - Choose Single Record so that each record starts at the top of the next page.
 - Choose Multiple Records to create more than one record per page. (For example, to print mailing labels.)
You cannot merge multiple records if the data fields appear on a document page in a document with multiple pages, or if data fields appear on multiple master pages.
 4. Select Generate Overset Text Report With Document Creation to automatically open a report that tracks overset conditions created during the merge of the data into the InDesign document. (See [Overset text reports](#).)
 5. Select Alert When Images Are Missing to display a missing link alert when one or more images are not available.
 6. If you selected Multiple Records on the Records tab, click the Multiple Record Layout tab, and specify the following:
 - For Margins, type values to specify the distance between margin guides and each edge of the page.
 - For Layout Of Records, select either Rows First or Columns First, and then specify the spacing between the columns and rows.
 7. If you selected Multiple Records, select Preview Multiple Record Layout to review changes made in the Create Merge Records dialog box. You can click the Page buttons to navigate the records.
 8. Click the Options tab and specify the placement options. (See [Content placement options](#).)
 9. When you're finished, click OK.
 10. If you're exporting directly to PDF, specify PDF options, and click Export. Then specify the filename and location, and click Save. (See [Adobe PDF options](#).)

If the data source file points to any unsupported file formats or images that are not available, you may need to correct the data source file to point to a supported file, correct the path to any missing file, or simply move the file to the correct folder so that InDesign can find it and place it.

Limitations for merging multiple records

You can choose Multiple Records to create more than one record per page. For example, if you are printing mailing labels, you'll want to print more than one label per page. The way the records will appear in the merged publication depends mainly on the layout options. Here is a list of limitations you might encounter when using the Multiple Records option:

- You cannot merge multiple records if the data fields appear on a document page in a document with multiple pages, or if data fields appear on multiple master pages.
- The Data Merge allows for only one size of place holder.
- Deleting a record in the merged publication will not reflow the remaining records into the empty placeholder.

Merging to a PDF file

When you merge to a PDF file, all the options are the same as when you create a merged InDesign document. The resulting PDF takes advantage of PDF XObjects for the static parts of the page, resulting in a reduced-size, efficient PDF.

[To the top](#)

Update data fields

After merging a document with data placeholders on master pages, you can change the layout of the merged document and still update the values of data fields in the data source. Use the Update Data Fields to update the data fields while maintaining the layout of the document. This option is available only in a merged document in which data placeholders appear on master pages.

1. Make any changes to the data source file, and then save and close the data source file.
2. In the merged document, choose Update Data Fields.

The changes that have been made by updating the data fields appear in a log file.

 *This option works best when you simply edit or add records in the data source file. If you add placeholder fields, add new fields to the data source, or change the settings in the Create Merged Document dialog box, use the Create Merged Document option to generate a new merged document.*

[To the top](#)

Overset text reports

The Overset Text Report appears if the Generate Overset Text Report option is selected in the Create Merged Document dialog box, and if one or more fields include overset text after the data is merged.

The report displays each overset instance in a numbered list showing the page number the text appears on, followed by overset character/word count and a snippet of the overset text.

If the report appears when you create a merged document, use the report to fix the overset condition. For example, you may want to increase the text frame size, decrease the font size, or edit the text.

[To the top](#)

Content placement options

The following options appear in the Content Placement Options dialog box:

Fit Images Proportionally Maintains the image's aspect ratio but scales the image to fit within the frame (default).

Fit Images To Frames Scales the image so that its aspect ratio is identical to the frame's aspect ratio.

Fit Frames To Images Preserves the image size but adjusts the frame size to match it.

Preserve Frame And Image Sizes Places the image at its intrinsic size into the frame, aligned to the upper-left corner of the frame. The image is cropped if too big for the frame.

Fill Frames Proportionally Places the image so that its height or width fills the frame, leaving the rest of the image cropped.

Center In Frame Aligns the center of the image to the center of the frame.

Link Images Creates a link, or file path, to the original image file. If this option is not selected, all image data is embedded in the InDesign document.

Remove Blank Lines For Empty Fields Remove paragraph returns inserted for empty fields. This is especially useful for mailings in which you have an optional address field. This option ignores soft returns. If any characters, including spaces, appear on the line, the line is not deleted.

Record Limit Per Document Specifies the maximum number of records for each merged document. When the threshold is reached, a new document is created with the number of pages necessary to hold the remaining records being merged (up to the per-record limit). This option is available only when Single Record is selected.

Page Limit Per Document Specifies the maximum number of pages for each document. When the threshold is reached, a new document is created with the number of pages necessary to hold the remaining records being merged (up to the per-page limit). This option is available only when Multiple Records is selected from the Records Per Document Page menu when merging.

 Twitter™ and Facebook posts are not covered under the terms of Creative Commons.

[Legal Notices](#) | [Online Privacy Policy](#)

Accessibility

[Creating accessible PDF documents \(PDF, 2.6 MB\)](#)

article (Jan. 1, 2011)

Structuring PDFs

[Adding structure to PDFs](#)

[How tags affect reuse and accessibility](#)

[Understanding and optimizing reflow](#)

[Tag page items](#)

[Label graphics for use with screen-reader software](#)

[Group page items into an Article element](#)

[To the top](#)

Adding structure to PDFs

When you export to Adobe PDF with the Create Tagged PDF option selected in the General area of the Export Adobe PDF dialog box, the exported pages are automatically tagged with a set of structure tags that describe the content, identifying page items such as headlines, stories, and figures. To add additional tags or to fine-tune existing ones before you export, you can use the Tags panel in InDesign. The Structure pane (View > Structure > Show Structure) reflects the changes.

You can improve the accessibility and reuse of Adobe PDF documents by adding tags to the InDesign document before you export. If your PDF documents don't contain tags, Adobe Reader or Acrobat may attempt to automatically tag the document when the user reads or reflows it, but the results may be disappointing. If you do not get the results you want in the exported PDF file, you can use tools in Acrobat 6.0 Professional and later to edit the structure of tagged PDF documents. For the most advanced tools, use Acrobat 9 Professional.

When you apply tags to a document for PDF export, the tags do not control which content is exported to PDF, as is the case with XML export. Instead, the tags give Acrobat more information about the document's structural contents.

Advantages of using tags

By applying tags to your document before exporting to PDF, you can do the following:

- Map InDesign paragraph style names to Acrobat tagged Adobe PDF paragraph styles to create a reflowable PDF file for viewing on handheld devices and other media.
- Mark and hide printing artifacts, text, and images so that they won't appear when reflowed in Acrobat. For example, if you tag a page item as Artifact, the page item will not be displayed when you reflow the contents of a tagged Adobe PDF document on a handheld device, a small display, or a monitor at a large magnification.
- Add alternative text to figures so that the text can be read aloud to the visually impaired with screen-reading software.
- Replace graphic letters, such as ornate drop-caps, with readable letters.
- Provide a title for a set of articles, or group stories and figures into articles.
- Order stories and figures to establish a reading order.
- Recognize tables, formatted lists, and tables of contents. Recognize which content blocks belong to the different stories.
- Include text formatting information such as Unicode values of characters, spacing between words, and the recognition of soft and hard hyphens.

[To the top](#)

How tags affect reuse and accessibility

The content of an Adobe PDF document can be reused for other purposes. For example, you might create an Adobe PDF file of a report with text, tables, and images, and then use various formats to distribute it: for printing or reading on a full-sized monitor, for viewing on a handheld device, for reading out loud by a screen reader, and for direct access through a web browser as HTML pages. The ease and reliability with which you can reuse the content depends on the underlying logical structure of the document.

To make sure that your Adobe PDF documents can be reused and accessed reliably, you must add tags to them. Tagging adds an underlying

organizational structure, or *logical structure tree*, to the document. The logical structure tree refers to the organization of the document's content, such as title page, chapters, sections, and subsection. It can indicate the precise reading order and improve navigation—particularly for longer, more complex documents—without changing the appearance of the PDF document.

For people who are not able to see or decode the visual appearance of documents, assistive technology can access the content of the document reliably by using the logical structure tree. Most assistive technology depends on this structure to convey the meaning of content and images in an alternative format, such as sound. In an untagged document, no such structure exists, and Acrobat must infer a structure based on the reading order choices in the preferences. This method is unreliable and often results in page items read in the wrong order or not read at all.

The tags appear on the Tags tab in Acrobat 6.0 and later, where they are nested according to the relationship definitions for the tagged elements. You cannot edit tags in Acrobat Standard. If your work requires you to work directly with tags, you should upgrade to Acrobat 9 Professional. For more information, see Acrobat Help.

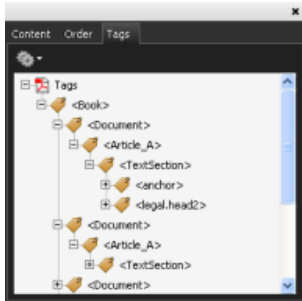

Logical structure tree on the Tags tab in Acrobat 9

Note: Tags used in Adobe PDF files can be compared to tags in HTML and XML files. To learn more about basic tagging concepts, see any of the many references and text books available in bookstores, in libraries, and on the Internet.

[To the top](#)

Understanding and optimizing reflow

You can *reflow* a PDF document to read it on handheld devices, smaller displays, or standard monitors at large magnifications, without having to scroll horizontally to read each line.

When you reflow an Adobe PDF document, some content carries into the reflowed document and some doesn't. In most cases, only readable text reflows into the reflowed document. Readable text includes articles, paragraphs, tables, images, and formatted lists. Text that doesn't reflow includes forms, comments, digital signature fields, and page artifacts, such as page numbers, headers, and footers. Pages that contain both readable text and form or digital signature fields don't reflow. Vertical text reflows horizontally.

As an author, you can optimize your PDF documents for reflow by tagging them. Tagging ensures that text blocks reflow and that content follows the appropriate sequences, so readers can follow a story that spans different pages and columns without other stories interrupting the flow. The reading order is defined by the structure tree, which you can change in the Structure pane.



Tag page items

You can tag text frames and graphics automatically or manually. After you tag page items, you can use the Structure pane to change the order of your page by dragging elements to a new location within the hierarchy. If you change the order of the elements in the Structure pane, these changes are passed on to the Adobe PDF file. The order of the elements becomes useful when the PDF file is saved from Acrobat as an HTML or XML file. The order is also useful when you export an InDesign document for Dreamweaver (XHTML) or Digital Editions (EPUB) format.

Tag page items automatically

When you choose the Add Untagged Items command, InDesign adds tags to the Tags panel, and applies the Story and Figure tags to certain untagged page items. The Story tag is applied to any untagged text frames, and the Figure tag is applied to any untagged graphics. You can then manually apply other tags to sections of text. However, automatically tagging page items does not guarantee that the items will be structured accordingly in the exported PDF file.

1. Choose Window > Utilities > Tags to display the Tags panel.
2. Choose View > Structure > Show Structure to display the Structure pane, to the left of the Document window.
3. Choose Add Untagged Items from the Structure pane menu.

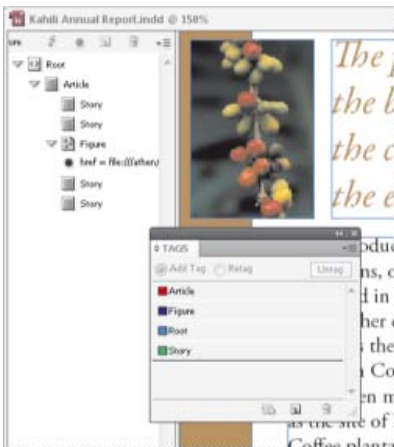

Tags in the Structure pane and Tags panel

Tag page items manually

1. Choose Window > Utilities > Tags to display the Tags panel.
2. Choose View > Structure > Show Structure to display the Structure pane, to the left of the Document window.
3. Choose Add Untagged Items from the Structure pane menu.
4. Select a page item in the document.

5. Select a tag in the Tags panel. Note the following suggested uses for certain imported tags:

Artifact The Artifact tag lets you hide page items, such as page numbers or unimportant objects, when viewing the exported PDF file in Reflow view, which displays only tagged items; see your Adobe Acrobat documentation. This is especially useful for viewing PDF files on a handheld device or in other PDF readers.

Cell Use this tag for table cells.

Figure Use this tag for placed graphics. The Figure tag is applied to all untagged graphics placed in your document when you choose Add Untagged Items.

Paragraph tags (P, H, H1–H6) These tags have no effect on the exported PDF text when viewed in Reflow view. However, they can be useful in some situations when exporting a PDF file to HTML format.

Story structure tag (PDF)Story Use this tag for stories. The Story tag is applied to all untagged text frames when you choose Add Untagged Items. For example, suppose you have an InDesign document formatted with three paragraph styles: Head1, Head2, and Body. First, map these paragraph styles to the H1, H2, and P tags, respectively. Next, export to PDF. Finally, when you export the PDF document to HTML or XML in Acrobat, the paragraphs tagged as H1, H2, and P will display appropriately (such as with large bold letters in H1) in a web browser. For information on exporting the PDF document to HTML or XML, see your Adobe Acrobat documentation.

[To the top](#)

Label graphics for use with screen-reader software

If you want screen readers to describe graphical elements that illustrate important concepts in the document, you must provide the description. Figures and multimedia aren't recognized or read by a screen reader unless you add alternate text to the tag properties.

The Alt text attribute lets you create alternate text that can be read in lieu of viewing an illustration. ActualText is similar to Alt text in that it appears in lieu of an image. The ActualText attribute lets you substitute an image that is part of a word, such as when a fancy image is used for a drop cap. In this example, the ActualText attribute allows the drop cap letter to be read as part of the word.

When you export to Adobe PDF, the Alt text and Actual Text attribute values are stored in the PDF file and can be viewed in Acrobat 6.0 and later. This alternate text information can then be used when the PDF file is saved from Acrobat as an HTML or XML file. For more information, see your Adobe Acrobat documentation.

1. If necessary, choose View > Structure > Show Structure to display the Structure pane, and choose Window > Utilities > Tags to display the Tags panel.
2. Choose Add Untagged Items from the Structure pane menu.
3. To make sure the image is tagged as Figure, select the image, and then select Figure in the Tags panel.
4. Select the Figure element in the Structure pane, and then choose New Attribute from the Structure pane menu.
5. For Name, type either **Alt** or **ActualText** (this feature is case-sensitive).
6. For Value, type the text that will appear instead of the image.

[To the top](#)

Group page items into an Article element

Use the Structure pane to logically group page items into an Article element. For example, if a set of stories spans multiple pages, you can create an umbrella element that will contain these stories in a single group. These umbrella elements are called *structural elements*. You can also name your grouped articles.

Note: You cannot tag grouped page items.

- To group page items, select New Element from the Structure pane menu, select the Article element in the Tags panel, and then drag page elements underneath it in the Structure pane.
- To name grouped items, right-click the Article element in the Structure pane and choose New Attribute. For Name, type **Title**. For Value, type the name of the article you want to use.

Adobe also recommends

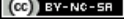
 Twitter™ and Facebook posts are not covered under the terms of Creative Commons.

[Legal Notices](#) | [Online Privacy Policy](#)

Forms | CC, CS6

What's covered

[Forms workflow](#)

[Add a form field](#)

[Specify tab order](#)

[To the top](#)

Forms workflow

You can design forms in InDesign and export them directly to PDF. InDesign now supports form fields and additional form actions. The Buttons and Forms library (Window > Interactive > Buttons and Forms) has form items that you can use to design interactive forms.

Using InDesign you can create simple forms within InDesign, without needing to touch up the PDF document in Acrobat after publishing. You can add simple form elements within the document pages. Common field types such as text fields, radio buttons, check boxes, or signatures are supported. You can also add actions to submit the form by email or to print it.

In addition to the basic design, you can also use creative capabilities in InDesign to add a designer touch to your form.

- Add solid strokes and fills to the PDF form fields.
- Add custom On, Off, and Hover states for buttons, check boxes, and radio buttons.
- Specify font size for text input fields.

For example, to collect credit card information, you could use credit card icons as radio buttons, with a different image for the selected state.

For advanced form workflows, you can export the basic form and then continue editing it in Adobe Acrobat.

[To the top](#)

Add a form field

Use the Buttons and Forms panel to add form fields to the layout. The procedures to add interactive form fields are the same as adding buttons so that you don't have to learn new procedures. You can create a form that works with Adobe Reader or Adobe Acrobat. Using InDesign, you can create some cool forms that you can't ordinarily using Acrobat.

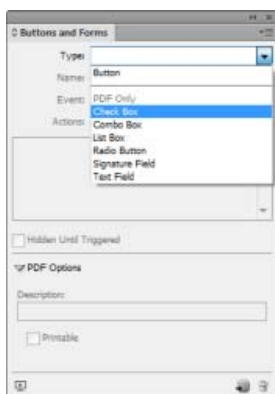

Buttons and Forms panel

1. Place a frame at the location where you want to place the form field.
2. Open the Buttons and Forms panel (Windows > Interactive > Buttons and Forms).
3. Select the frame and from the Type list choose a form element type. Alternatively, right-click a frame and choose Interactive > Convert to [...]

4. Enter a name for the form field. To create a radio button group, all the individual buttons must have the same name.
5. Choose an event and add actions to associate with it. Actions such as Clear Form, Print Form, and Submit Form have been added. In the Submit Form action specify the URL as "mailto:xyz@example.com".
6. For a radio button, check box, or buttons: set appearance attributes for different states. InDesign adds default graphics for the various states, but you can add your own.
7. Specify PDF options:
 - Description - Entered value is displayed as the tool tip and is used for creating accessible forms
 - Button Value - this value corresponds to the export value in Acrobat and can also be used to identify a radio button in a group in a accessible form.

[To the top](#)

Specify tab order

To create user friendly and accessible forms, it is necessary to assign a usable tab order. Users can navigate through the form fields without using a pointing device. Pressing the Tab key shifts the focus to the next logical field.

There are two methods of specifying a tab order in a tagged PDF:

- Use the Articles panel (Windows > Article) to specify a custom tab order
- Choose Object > Interactive > Set Tab Order.

Use Articles to specify tab order

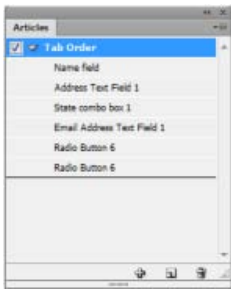

Use the Articles panel to specify tab order

1. Open the Articles panel (Window > Articles).
2. Drag the form fields to the Articles panel.
3. In the articles panel, drag to reorder the fields in the required order.

 *To enable screen readers to use the specified order, from the Articles panel menu, enable Use for Reading Order in Tagged PDFs. Remember to enable the Create Tagged PDF option while exporting the PDF.*

Use Structure to specify tab order

1. Choose Objects > Interactive > Set Tab Order.
2. Click Move Up or Move Down to arrange the items in the desired tab order.

While exporting to interactive PDF, enable Use Structure for Tab Order in the PDF Export dialog box.

See also

- [Working with Articles](#)
- [Export to interactive PDF options](#)



Twitter™ and Facebook posts are not covered under the terms of Creative Commons.

[Legal Notices](#) | [Online Privacy Policy](#)

Articles (CS5.5)

[Introduction to articles](#)

[Create an article and add content to it](#)

[Add all page items in a document to an article](#)

[Managing articles](#)

[Include articles for export](#)

[To the top](#)

Introduction to articles

Articles provide an easy way to create relationships among page items. These relationships can be used to define the content to be exported to EPUB, HTML, or Accessible PDFs; and to define the order of the content. You can create articles from a combination of existing page items within a layout, including images, graphics, or text. Once an article has been created, page items can be added, removed, or reordered. Articles can be created manually by dragging one or more page items to an article in the Articles panel.

You can also add bulk content to an article. Adding selected content to selected article, or adding an entire document content to an article is supported.

Note: *The XML structure panel provides another mechanism to decide the order of the content to be exported to the ePub, HTML, and Accessible PDF exports workflows. The Articles panel is designed to be simpler, easier to use, and more accessible, for people without XML skills. However, the ability to use the XML structure panel has not been removed; it is now an option alongside the use of the Articles panel during the export process. See [Structuring documents for XML](#).*

[To the top](#)

Create an article and add content to it

1. Choose Window > Articles to open the Articles panel.

2. Select the page items to add to the article.

 *To create an empty article, don't select a page item in the layout.*

3. Do one of the following:

- Choose New Article from the Articles panel menu.
- Click Create New Article  at the bottom of the Articles panel.
- Drag story or page element to the Articles panel.

4. In the New Article dialog box, enter a name for the article.

5. Select Include When Exporting to add the article to the EPUB/HTML export output.

[To the top](#)

Add all page items in a document to an article

To add all the page items to an article:

1. Choose Window > Articles to open the Articles panel.
2. Select an article to add the items to. If you don't select an article, a new article is created.
3. Press Command (Mac OS) or Ctrl (Windows) and then click the  in the Articles panel.
4. If a New Article dialog box opens, enter a name for the article.
5. Select Include When Exporting to add the article to the EPUB/HTML export.

 *If you've selected an article, choose Add Document Content to Selected Articles from the articles panel menu.*

[To the top](#)

Managing articles

You can manage articles using the Articles panel. You can drag page elements into the Articles panel to add them to an article. Drag items in the Articles panel to change the order, or move them from one article to another.

The Articles panel pop-up menu also provides options to manage content.

[To the top](#)

Include articles for export

You can create articles and select which articles to include while exporting to EPUB or HTML. By default, all articles are selected for export.

To include an article while exporting, in the Articles panel, select the article and do one of the following:

- Select the check box next to the article.
- Choose Article Options from the Articles panel pop-up menu and then select Include When Exporting.

 Twitter™ and Facebook posts are not covered under the terms of Creative Commons.

[Legal Notices](#) | [Online Privacy Policy](#)